

20' X 40' RECTANGLE 6" RADIUS - BOWTIE

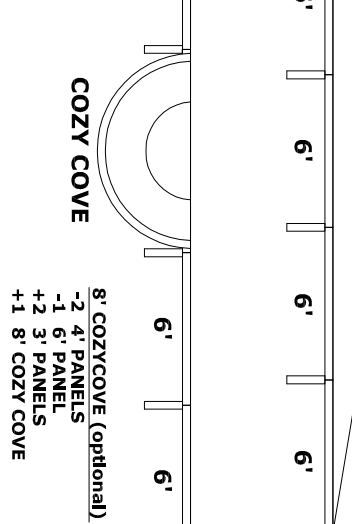
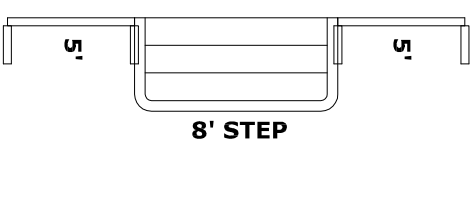
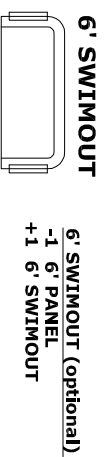
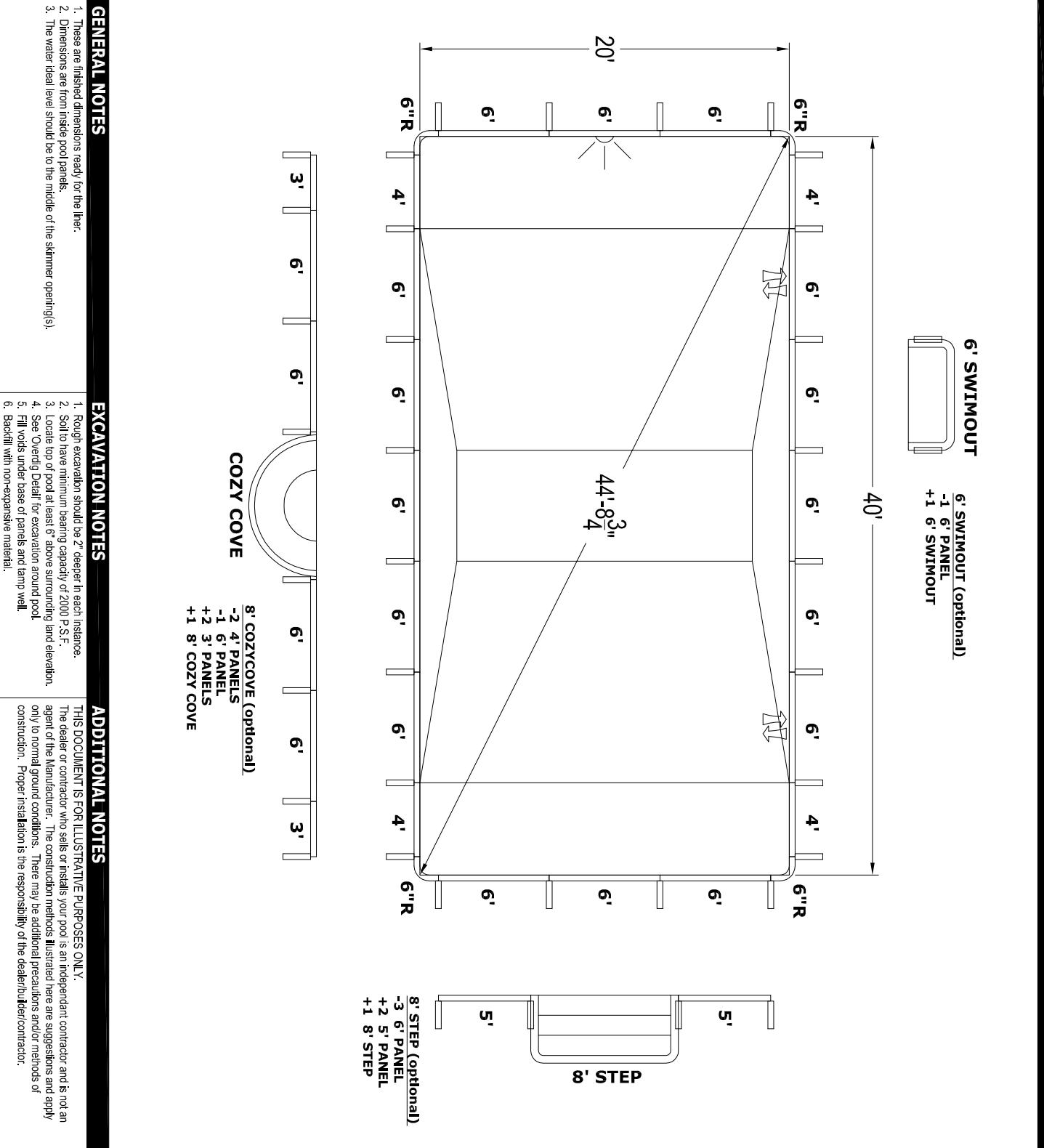

GENERAL NOTES

1. These are finished dimensions ready for the liner.
2. Dimensions are from inside pool panels.
3. The water level should be to the middle of the skimmer opening(s).

EXCAVATION NOTES

1. Rough excavation should be 2" deeper in each instance.
2. Soil to have minimum bearing capacity of 2000 P.S.F.
3. Locate top of pool at least 6" above surrounding land elevation.
4. See 'Overdig Detail' for excavation around pool.
5. Fill voids under base of panels and lamp well.
6. Backfill with non-expansive material.

ADDITIONAL NOTES

THIS DOCUMENT IS FOR ILLUSTRATIVE PURPOSES ONLY.
 The dealer or contractor who sells or installs your pool is an independent contractor and is not an agent of the Manufacturer. The construction methods illustrated here are suggestions and apply only to normal ground conditions. There may be additional precautions and/or methods of construction. Proper installation is the responsibility of the dealer/contractor.

DIMENSIONS

A	20'	K	6'
B	40'	L	12'
D	3 1/4"	M	5'
E	2 8"	M2	5'
F	6'	T	-
G	16'	S	-
H	2'	N	-
I	2'	P	-
J	12'	U	-

-	-	SQ. FOOTAGE	800
PERIMETER	119'2"	GALLONS	23,994

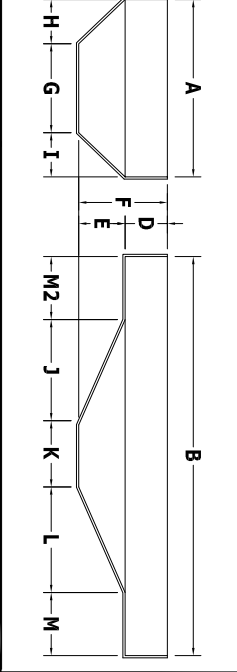

BILL OF MATERIALS

QTY	PART	DESCRIPTION
13	HP206	6' PANEL
1	HP206L	6' PANEL (LIGHT)
2	HP206A	6' PANEL (A/G)
4	HP204	4' PANEL
4	HP256	6"R PANEL
24	HP199	BRACE

OVERDIG DETAIL

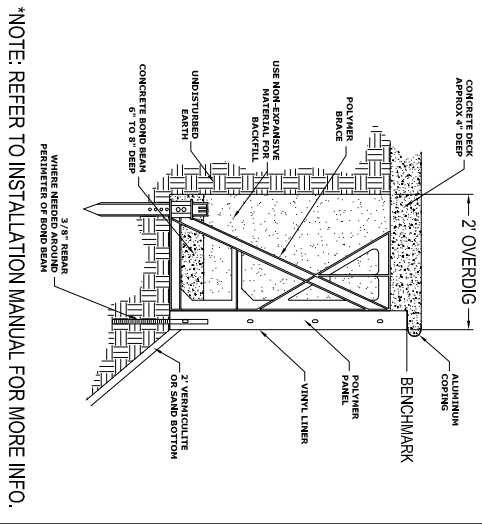

COPING LAYOUT

NO DIVING WARNING

ATTENTION DEALER/BUILDER:
 It is your responsibility to ensure the safety package provided is delivered to the pool owner and that the "NO DIVING" labels are properly installed.

NO DIVING WARNING LABELS MUST BE INSTALLED IN NO DIVING AREAS ACCORDING TO NSPI SPECIFICATIONS

ADANGER
NO DIVING
SHALLOW WATER
 DIVING MAY CAUSE SERIOUS OR FATAL INJURY

SUGGESTED LABEL LOCATIONS ARE SPECIFIED IN THE COPING LAYOUT

PRE-CUT PANEL LEGEND

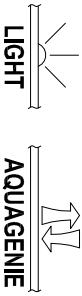

DATE	PANEL LINE	DRAWING TITLE	DRAWING NUMBER
JAN 2012	CORNERSTONE	20' X 40' RECTANGLE 6" RADIUS - BOWTIE	20162-PWH

543 South Main Street - Sweetwater, TN 37874