

24' OCTAGON

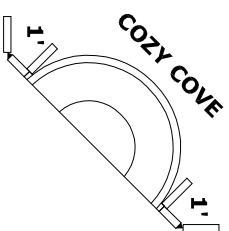

- 8' COZY COVE (optional)
- 1 6' PANEL
- 1 4' PANEL
- +2 1' PANEL
- +1 BRACE
- +1 8' COZY COVE

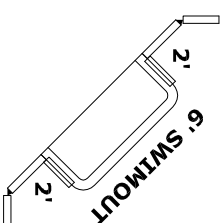

- 6' SWIMOUT (optional)
- 1 6' PANEL
- 1 4' PANEL
- +2 2' PANELS
- +1 BRACE
- +1 6' SWIMOUT

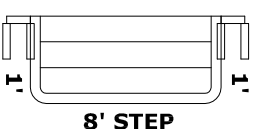
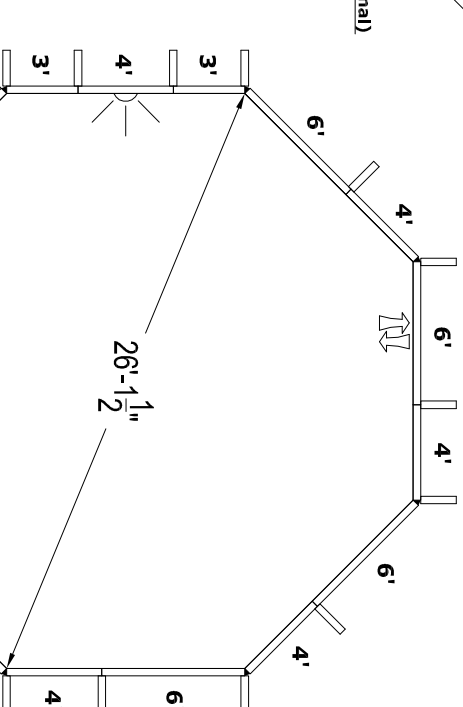

- 8' STEP (optional)
- 1 6' PANEL
- 1 4' PANEL
- +2 1' PANEL
- +1 BRACE
- +1 8' STEP

BOTTOM IS DISHED EVENLY TO CENTER

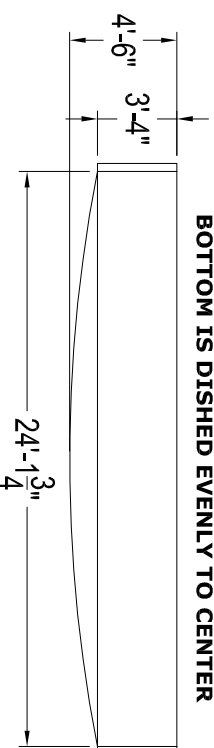

GENERAL NOTES

1. These are finished dimensions ready for the liner.
2. Dimensions are from inside pool panels.
3. The ideal water level should be to the middle of the skimmer opening(s).

EXCAVATION NOTES

1. Rough excavation should be 2" deeper in each instance.
2. Soil to have minimum bearing capacity of 2000 P.S.F.
3. Locate top of pool at least 6" above surrounding land elevation.
4. See 'Overdig Detail' for excavation around pool.
5. Fill voids under base of panels and lamp well.
6. Backfill with non-expansive material.

ADDITIONAL NOTES

THIS DOCUMENT IS FOR ILLUSTRATIVE PURPOSES ONLY.

The dealer or contractor who sells or installs your pool is an independent contractor and is not an agent of the Manufacturer. The construction methods illustrated here are suggestions and apply only to normal ground conditions. There may be additional precautions and/or methods of construction. Proper installation is the responsibility of the dealer/contractor.

DIMENSIONS

LETTER	VALUE	UNIT	SQ. FOOTAGE	GALLONS
A	24'-1 3/4"	K	-	-
B	24'-1 3/4"	L	12 3/4"	-
D	3'-4"	M	-	-
E	1'-2"	M2	-	-
F	4'-6"	T	-	-
G	-	S	-	-
H	12 3/4"	N	-	-
I	12 3/4"	P	-	-
J	12 3/4"	U	-	-
PERIMETER		80'	584	12976

BILL OF MATERIALS

QTY	PART	DESCRIPTION
6	HP206	6' PANEL
1	HP206A	6' PANEL (A/G)
7	HP204	4' PANEL
1	HP204L	4' PANEL (LIGHT)
2	HP203	3' PANEL
8	HP213	45° WEDGE
17	HP199	BRACE

OVERDIG DETAIL

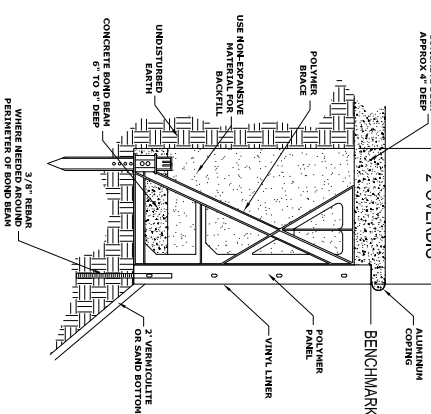

*NOTE: REFER TO INSTALLATION MANUAL FOR MORE INFO.

COPING LAYOUT

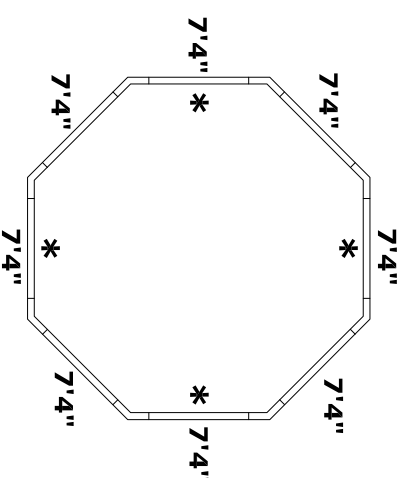

NO DIVING WARNING

ATTENTION DEALER/BUILDER:
It is your responsibility to ensure the safety package provided is delivered to the pool owner and that the "NO DIVING" labels are properly installed.

***NO DIVING: WARNING LABELS MUST BE INSTALLED IN NO DIVING AREAS ACCORDING TO NSPI SPECIFICATIONS**

ADANGER

NO DIVING SHALLOW WATER
DIVING MAY CAUSE DEATH OR SERIOUS INJURY



*** SUGGESTED LABEL LOCATIONS ARE SPECIFIED IN THE COPING LAYOUT**

PRE-CUT PANEL LEGEND

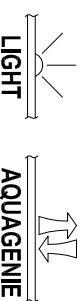

DATE	PANEL LINE	DRAWING TITLE
JAN 2012	CORNERSTONE	24' OCTAGON

DRAWING NUMBER
20260-PWH



543 South Main Street - Sweetwater, TN 37874