

REVISION HISTORY				
REV.	DESCRIPTION	DATE	ECO	BY

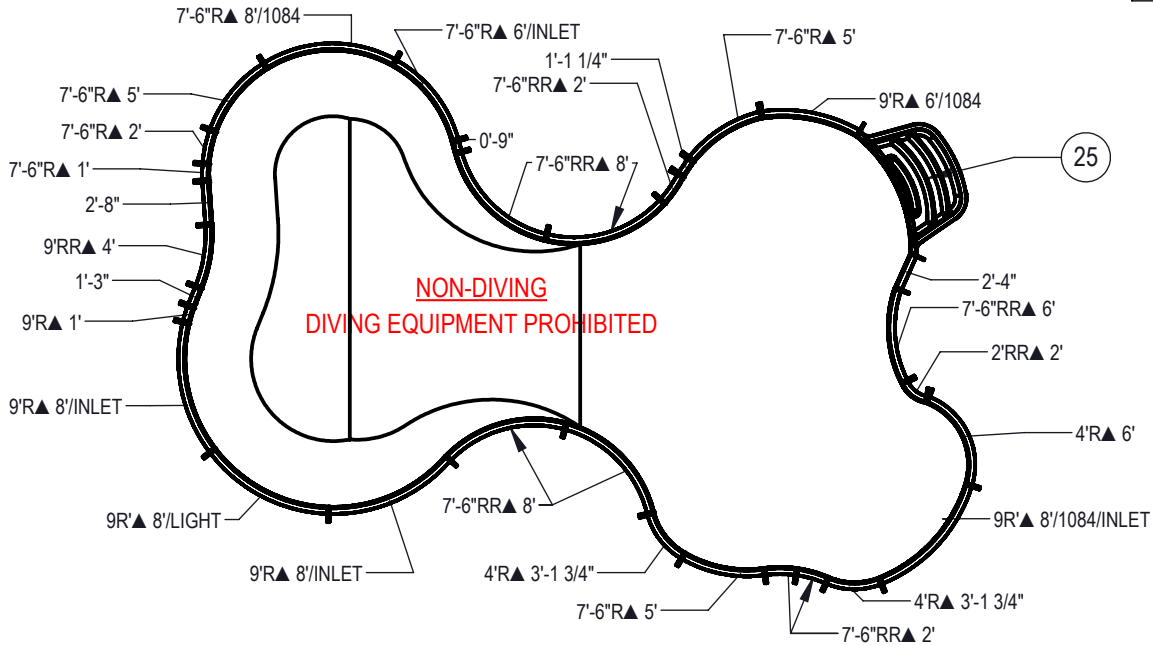

**NON-DIVING
DIVING EQUIPMENT PROHIBITED**

25

NOTES:

- THESE ARE FINISHED DIMENSIONS READY FOR THE LINER.
- DIMENSIONS ARE FROM INSIDE POOL PANELS.
- ROPE AND FLOAT ASSEMBLY SHOULD BE INSTALLED IN ACCORDANCE WITH CURRENT ANSI/ASPS/ICC REGULATIONS
- HYDRA LINER TRACK FOR STEPS IS INSTALLED WITH THE BARB FACING THE RISER WALL ON THE STEP.

EXCAVATION NOTES:

- ROUGH EXCAVATION SHOULD BE 2" DEEPER IN EACH INSTANCE.
- SOIL TO HAVE MINIMUM BEARING CAPACITY OF 1500 PSF.
- LOCATE TOP OF POOL AT LEAST 6" ABOVE THE SURROUNDING LAND ELEVATION.
- SEE "OVER DIG DETAIL" FOR EXCAVATION AROUND POOL.
- FILL VOIDS UNDER BASE OF PANELS AND TAMP WELL.
- BACK FILL WITH NON-EXPANSIVE MATERIAL.
- FOLLOW ALL CURRENT ANSI / APSP / ICC GUIDELINES FOR RESIDENTIAL POOLS

IMPORTANT NOTES:

THIS DOCUMENT IS FOR ILLUSTRATIVE PURPOSES ONLY. THE DEALER OR CONTRACTOR WHO SELLS OR INSTALLS YOUR POOL IS AN INDEPENDENT CONTRACTOR AND IS NOT AN AGENT OF THE MANUFACTURER. THE CONSTRUCTION METHODS ILLUSTRATED HERE ARE SUGGESTIONS AND APPLY ONLY TO NORMAL GROUND CONDITIONS. THERE MAY BE ADDITIONAL PRECAUTIONS AND/OR METHODS OF CONSTRUCTION. PROPER INSTALLATION IS THE RESPONSIBILITY OF THE DEALER/BUILDER/CONTRACTOR.

ITEM	FILE NAME	DESCRIPTION	CUSTOMER DRAWING #	VENDOR PART #	QTY.
1	BOLT, PACK	BOLT, FLANGE, 3/8-16 X 1", PACK (50)	HPS1916	HPS1916	8
2	SBRACE	BRACE, FOLD OVER WITH TURNBUCKLE, STEEL, HPSFOB	HPSFOB	HPSFOB	32
3	PANEL, STRAIGHT	PANEL, 0'-9" LONG, 600 SERIES	HPSD9P	00001694	1
4	PANEL, STRAIGHT	PANEL, 1'-1 1/4" LONG, 600 SERIES	HPSCR2	00006567	1
5	PANEL, STRAIGHT	PANEL, 1'-3" LONG, 600 SERIES	HPSC2	00010755	1
6	PANEL, RR	PANEL, 2' REVERSE RADIUS, 2' LONG, 600 SERIES	HPSCRR3	00002029	1
7	PANEL, STRAIGHT	PANEL, 2'-4" LONG, 600 SERIES	HPSCS3	00001983	1
8	PANEL, STRAIGHT	PANEL, 2'-8" LONG, 600 SERIES	HPSCS3P	00002156	1
9	PANEL, RADIUS	PANEL, 4' RADIUS, 3'- 1 3/4" LONG, 600 SERIES	HPSCR4	00003051	2
10	PANEL, RADIUS	PANEL, 4' RADIUS, 6' LONG, 600 SERIES	HPSCR8	00005860	1
11	PANEL, RADIUS	PANEL, 7'-6" RADIUS, 1' LONG, 600 SERIES	HPSCR2	00006224	1
12	PANEL, RADIUS	PANEL, 7'-6" RADIUS, 2' LONG, 600 SERIES	HPSCR3	00002377	1
13	PANEL, RADIUS	PANEL, 7'-6" RADIUS, 5' LONG, 600 SERIES	HPSCR6	00006485	3
14	PANEL, RADIUS	PANEL, 7'-6" RADIUS, 8' LONG, INLET, 600 SERIES	HPSCR7	00006474	1
15	PANEL, RADIUS	PANEL, 7'-6" RADIUS, 8' LONG, 1084, 600 SERIES	HPSCR8	00006473	1
16	PANEL, RR	PANEL, 7'-6" REVERSE RADIUS, 2' LONG, 600 SERIES	HPSD76RR2	00000189	3
17	PANEL, RR	PANEL, 7'-6" REVERSE RADIUS, 6' LONG, 600 SERIES	HPS76RR6	00000193	1
18	PANEL, RR	PANEL, 7'-6" REVERSE RADIUS, 8' LONG, 600 SERIES	HPSD76RR8	00001754	4
19	PANEL, RADIUS	PANEL, 9' RADIUS, 1' LONG, 600 SERIES	HPSD9R1	00000348	1
20	PANEL, RADIUS	PANEL, 9' RADIUS, 6' LONG, 1084, 600 SERIES	HPS9R684	00005923	1
21	PANEL, RADIUS	PANEL, 9' RADIUS, 8' LONG, 1084, INLET, 600 SERIES	HPS9R884	00003874	1
22	PANEL, RADIUS	PANEL, 9' RADIUS, 8' LONG, LIGHT, 600 SERIES	HPSD9R8L	00000398	1
23	PANEL, RADIUS	PANEL, 9' RADIUS, 8', INLET OR LED, 600 SERIES	HPS9R8I	00000275	2
24	PANEL, RR	PANEL, 9' REVERSE RADIUS, 4' LONG, 600 SERIES	HPSD9RR4	00000414	1
25	HS311N	STEP, 8' RADIUS, 4 TREAD, CANTILEVER	HS311N	HS311N	1
26	PANEL, WEDGE	WEDGE, 2 1/2" X 2 1/2" X 14.5"	HPSCW1	00002480	1
27	PANEL, WEDGE	WEDGE, 42" X 2 1/2" X 2 1/2" X 13"	HPSD13W	00004886	1

ENGINEERING DRAWING NUMBER: 00017440	WEIGHT: 310739.0 lbs	UNLESS OTHERWISE SPECIFIED DIMENSIONS ARE IN INCHES TOLERANCES DECIMALS: X ± .1 XX ± .01 XXX ± .001 XXXX ± .0005 ANGULAR: X ± 0.5 THIRD ANGLE PROJECTION
	VOLUME: Inch ³	
	COLOR:	
	HEAT TREAT:	
	FINISH:	
	TEXTURE:	

DESIGNED BY: BUMPHREY	CREATION DATE: 9/12/2013
DETAILED BY: BUMPHREY	DETAILED DATE: 1/30/2018
LAST REVISED BY: bumphrey	LAST REVISED DATE: 1/30/2018
MATERIAL:	

HYDRA POOLS	
TITLE: LAYOUT, 27'9" X 47'7", DUBAI, 8' DEEP, HS311N, LIGHT, 3-1084, 4-INLET, 600 SERIES	
PART NUMBER: 00017440	SCALE: 1:256 SHEET: 1 OF 4
	A

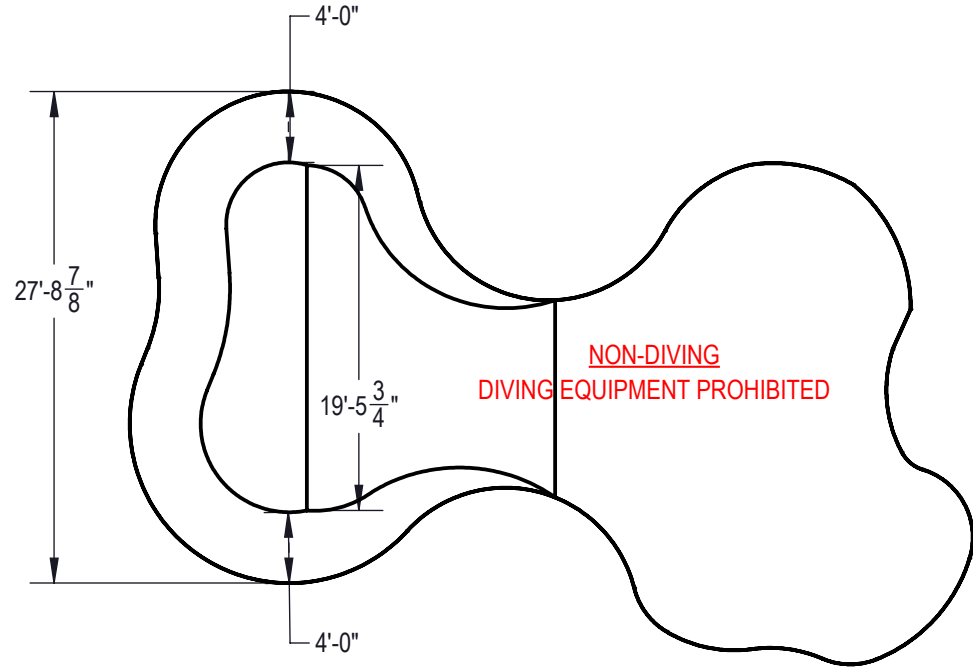
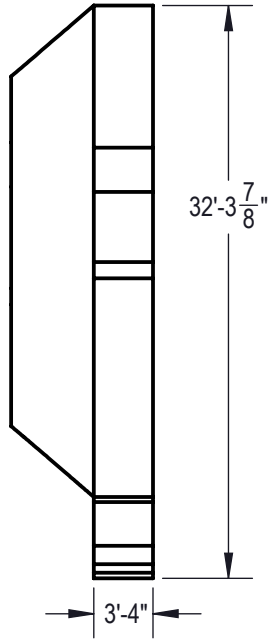

Area: 950.53ft ^2
Perimeter: 149.39ft
Volume = 33511 US gallons

NOTES:

1. THESE ARE FINISHED DIMENSIONS READY FOR THE LINER.
2. DIMENSIONS ARE FROM INSIDE POOL PANELS.
3. ROPE AND FLOAT ASSEMBLY SHOULD BE INSTALLED IN ACCORDANCE WITH CURRENT ANSI/ASPS/ICC REGULATIONS
4. HYDRA LINER TRACK FOR STEPS IS INSTALLED WITH THE BARB FACING THE RISER WALL ON THE STEP.

EXCAVATION NOTES:

5. ROUGH EXCAVATION SHOULD BE 2" DEEPER IN EACH INSTANCE.
6. SOIL TO HAVE MINIMUM BEARING CAPACITY OF 1500 PSF.
7. LOCATE TOP OF POOL AT LEAST 6" ABOVE THE SURROUNDING LAND ELEVATION.
8. SEE "OVER DIG DETAIL" FOR EXCAVATION AROUND POOL.
9. FILL VOIDS UNDER BASE OF PANELS AND TAMP WELL.
10. BACK FILL WITH NON-EXPANSIVE MATERIAL.
11. FOLLOW ALL CURRENT ANSI / APSP / ICC GUIDELINES FOR RESIDENTIAL POOLS

IMPORTANT NOTES:

THIS DOCUMENT IS FOR ILLUSTRATIVE PURPOSES ONLY. THE DEALER OR CONTRACTOR WHO SELLS OR INSTALLS YOUR POOL IS AN INDEPENDENT CONTRACTOR AND IS NOT AN AGENT OF THE MANUFACTURER. THE CONSTRUCTION METHODS ILLUSTRATED HERE ARE SUGGESTIONS AND APPLY ONLY TO NORMAL GROUND CONDITIONS. THERE MAY BE ADDITIONAL PRECAUTIONS AND/OR METHODS OF CONSTRUCTION. PROPER INSTALLATION IS THE RESPONSIBILITY OF THE DEALER/BUILDER/CONTRACTOR.

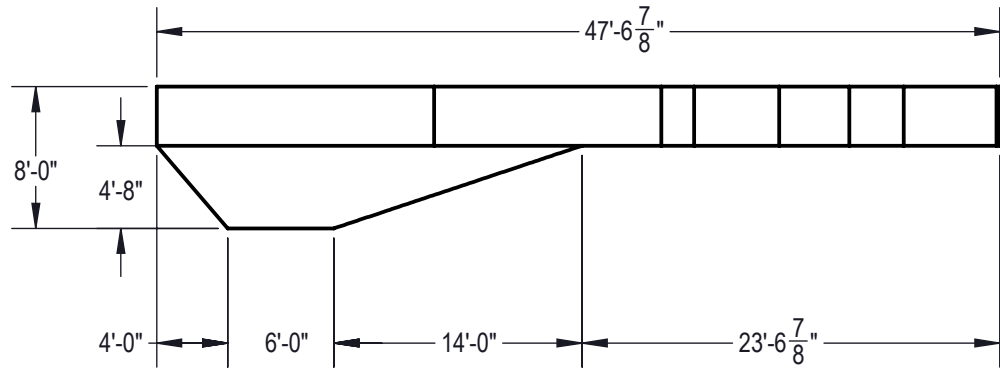

ENGINEERING DRAWING NUMBER: 00017440	WEIGHT:	UNLESS OTHERWISE SPECIFIED DIMENSIONS ARE IN INCHES TOLERANCES DECIMALS: X ± .1 XX ± .01 XXX ± .001 XXXX ± .0005 ANGULAR: X ± 0.5 THIRD ANGLE PROJECTION 	DESIGNED BY:	CREATION DATE:	HYDRA POOLS
	lbs		BUMPHREY	9/12/2013	
	VOLUME:		DETAILED BY:	DETAILED DATE:	TITLE: LAYOUT, 27'9" X 47'7", DUBAI, 8' DEEP, HS311N, LIGHT, 3-1084, 4-INLET. 600 SERIES
	Inch³		BUMPHREY	1/30/2018	
	NA		LAST REVISED BY:	LAST REVISED DATE:	
COLOR:	bumphrey	1/30/2018	PART NUMBER:	SCALE:	SIZE:
HEAT TREAT:	MATERIAL:		00017440	1:256	A
FINISH:				SHEET:	
TEXTURE:				2 OF 4	

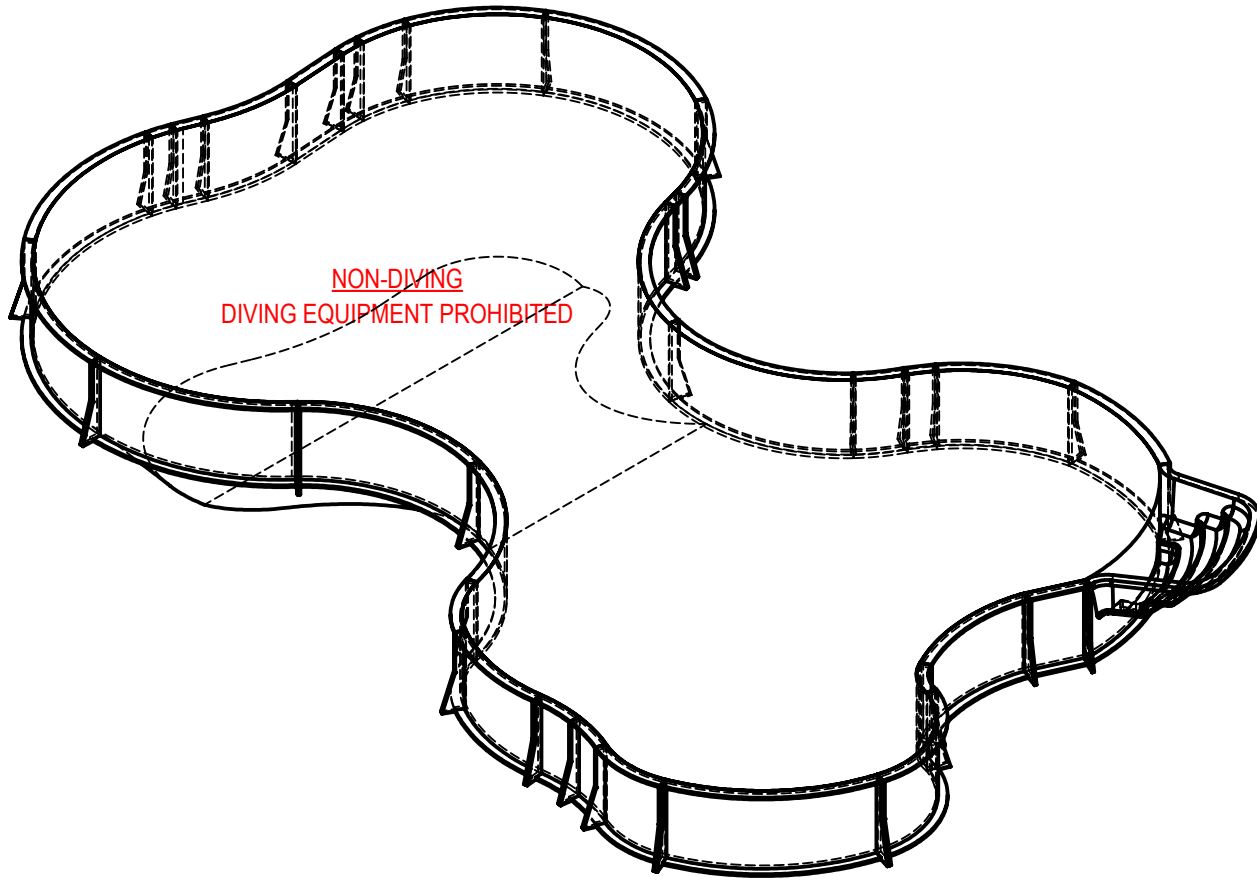

**NON-DIVING
DIVING EQUIPMENT PROHIBITED**

ENGINEERING DRAWING NUMBER: 00017440	WEIGHT: 310739.0 lbs	UNLESS OTHERWISE SPECIFIED DIMENSIONS ARE IN INCHES TOLERANCES DECIMALS: X ± .1 XX ± .01 XXX ± .001 XXXX ± .0005 ANGULAR: X ± 0.5 THIRD ANGLE PROJECTION 	DESIGNED BY: BUMPHREY	CREATION DATE: 9/12/2013	HYDRA POOLS	
	VOLUME: Inch³		DETAILED BY: BUMPHREY	DETAILED DATE: 1/30/2018		
	COLOR:		LAST REVISED BY: bumphrey	LAST REVISED DATE: 1/30/2018		
	HEAT TREAT:		MATERIAL:		TITLE: LAYOUT, 27'9" X 47'7", DUBAI, 8' DEEP, HS311N, LIGHT, 3-1084, 4-INLET. 600 SERIES	
	FINISH:				PART NUMBER:	
	TEXTURE:				00017440	
				SCALE: 1:84	SIZE: A	
				SHEET: 3 OF 4		

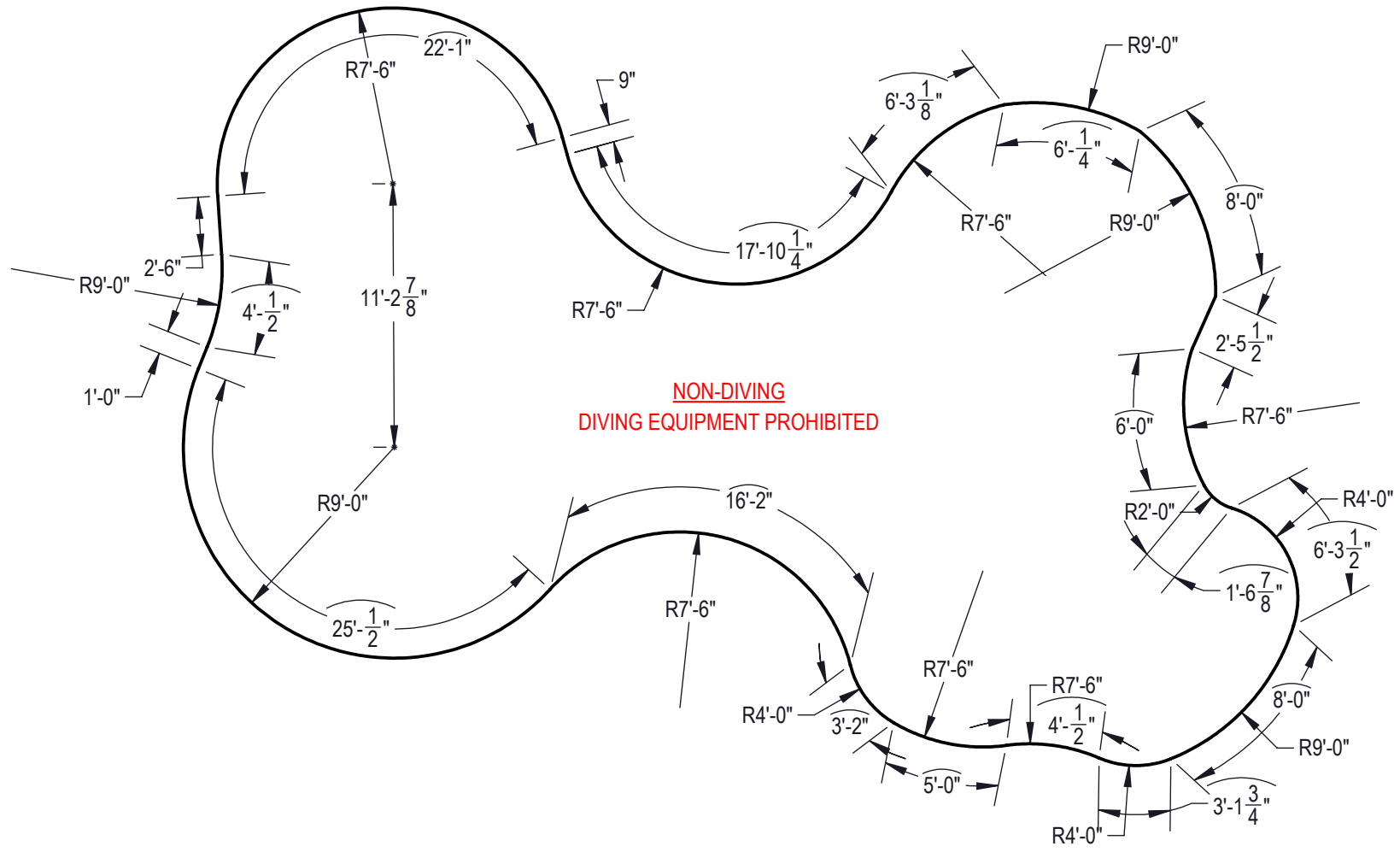

**NON-DIVING
DIVING EQUIPMENT PROHIBITED**

ENGINEERING DRAWING NUMBER: 00017440	WEIGHT:	UNLESS OTHERWISE SPECIFIED DIMENSIONS ARE IN INCHES TOLERANCES DECIMALS: X ± .1 XX ± .01 XXX ± .001 XXXX ± .0005 ANGULAR: X ± 0.5 THIRD ANGLE PROJECTION 	DESIGNED BY:	CREATION DATE:	HYDRA POOLS TITLE: LAYOUT, 27'9" X 47'7", DUBAI, 8' DEEP, HS311N, LIGHT, 3-1084, 4-INLET. 600 SERIES PART NUMBER: 00017440
	lbs		BUMPHREY	9/12/2013	
	VOLUME:		DETAILED BY:	DETAILED DATE:	
	Inch ³		BUMPHREY	1/30/2018	
	COLOR:		LAST REVISED BY:	LAST REVISED DATE:	
	NA		bumphrey	1/30/2018	
HEAT TREAT:	MATERIAL:		SCALE:	SIZE:	
NA			1:84	A	
FINISH:			SHEET:		
NA			4 OF 4		
TEXTURE:					
NA					