

REVISION HISTORY				
REV.	DESCRIPTION	DATE	ECO	BY

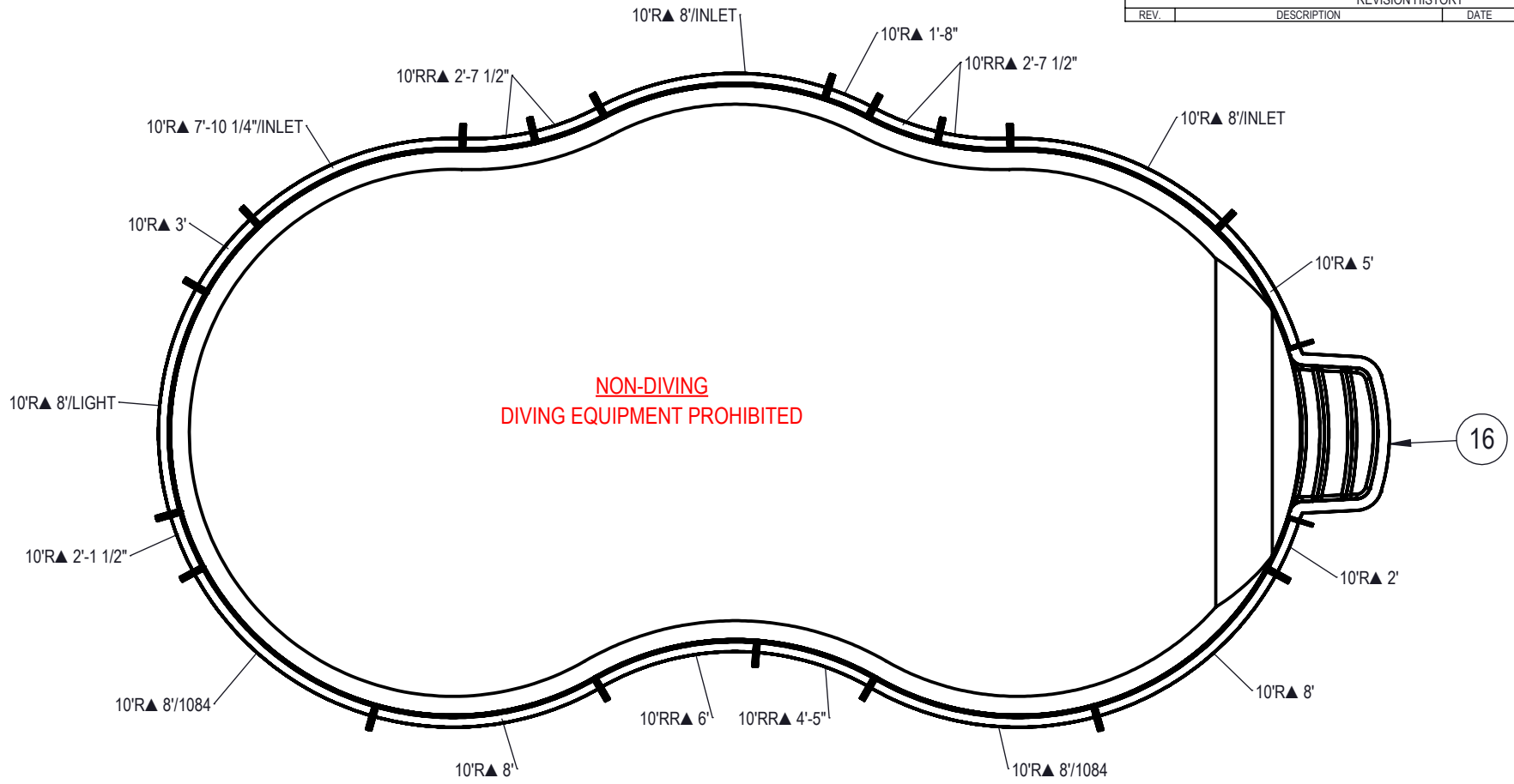

**NON-DIVING
DIVING EQUIPMENT PROHIBITED**

16

NOTES:

1. THESE ARE FINISHED DIMENSIONS READY FOR THE LINER.
2. DIMENSIONS ARE FROM INSIDE POOL PANELS.
3. ROPE AND FLOAT ASSEMBLY SHOULD BE INSTALLED IN ACCORDANCE WITH CURRENT ANSI/ASPS/ICC REGULATIONS
4. HYDRA LINER TRACK FOR STEPS IS INSTALLED WITH THE BARB FACING THE RISER WALL ON THE STEP.

EXCAVATION NOTES:

5. ROUGH EXCAVATION SHOULD BE 2" DEEPER IN EACH INSTANCE.
6. SOIL TO HAVE MINIMUM BEARING CAPACITY OF 1500 PSF.
7. LOCATE TOP OF POOL AT LEAST 6" ABOVE THE SURROUNDING LAND ELEVATION.
8. SEE "OVER DIG DETAIL" FOR EXCAVATION AROUND POOL.
9. FILL VOIDS UNDER BASE OF PANELS AND TAMP WELL.
10. BACK FILL WITH NON-EXPANSIVE MATERIAL.
11. FOLLOW ALL CURRENT ANSI / APSP / ICC GUIDELINES FOR RESIDENTIAL POOLS

IMPORTANT NOTES:

THIS DOCUMENT IS FOR ILLUSTRATIVE PURPOSES ONLY. THE DEALER OR CONTRACTOR WHO SELLS OR INSTALLS YOUR POOL IS AN INDEPENDENT CONTRACTOR AND IS NOT AN AGENT OF THE MANUFACTURER. THE CONSTRUCTION METHODS ILLUSTRATED HERE ARE SUGGESTIONS AND APPLY ONLY TO NORMAL GROUND CONDITIONS. THERE MAY BE ADDITIONAL PRECAUTIONS AND/OR METHODS OF CONSTRUCTION. PROPER INSTALLATION IS THE RESPONSIBILITY OF THE DEALER/BUILDER/CONTRACTOR.

ITEM	FILE NAME	DESCRIPTION	CUSTOMER DRAWING #	VENDOR PART #	QTY.
1	BOLT, PACK	BOLT, FLANGE, 3/8-16 X 1", PACK (50)	HPS1916	HPS1916	5
2	SBRACE	BRACE, FOLD OVER WITH TURNBUCKLE, STEEL, HPSFOB	HPSFOB	HPSFOB	20
3	PANEL, RADIUS	PANEL, 10' RADIUS, 1'-8" LONG, 600 SERIES	HPSCR2	00008149	1
4	PANEL, RADIUS	PANEL, 10' RADIUS, 2' LONG, 600 SERIES	HPS10R2	00002055	1
5	PANEL, RADIUS	PANEL, 10' RADIUS, 2'-1 1/2" LONG, 600 SERIES	HPSCR3	00006559	1
6	PANEL, RADIUS	PANEL, 10' RADIUS, 3' LONG, 600 SERIES	HPS10R3	00002098	1
7	PANEL, RADIUS	PANEL, 10' RADIUS, 5' LONG, 600 SERIES	HPSD10R5	00000707	1
8	PANEL, RADIUS	PANEL, 10' RADIUS, 7'-10 1/4" LONG, INLET, 600 SERIES	HPSCR8	00013572	1
9	PANEL, RADIUS	PANEL, 10' RADIUS, 8' LONG 1084, 600 SERIES	HPSD10R884	00000241	2
10	PANEL, RADIUS	PANEL, 10' RADIUS, 8' LONG, 600 SERIES	HPSD10R8	00000999	2
11	PANEL, RADIUS	PANEL, 10' RADIUS, 8' LONG, INLET, 600 SERIES	HPS10R8I	00002082	2
12	PANEL, RADIUS	PANEL, 10' RADIUS, 8' LONG, LIGHT, 600 SERIES	HPSD10R8L	00001014	1
13	PANEL, RR	PANEL, 10' REVERSE RADIUS, 2'-7 1/2" LONG, 600 SERIES	HPSCR3	00006134	4
14	PANEL, RR	PANEL, 10' REVERSE RADIUS, 4'-5" LONG, 600 SERIES	HPSCR5	00006648	1
15	PANEL, RR	PANEL, 10' REVERSE RADIUS, 6' LONG, 600 SERIES	HPSD10RR6	00001015	1
16	HS303N	STEP, 9' RADIUS, 3 TREAD, CANTILEVER	HS303N	HS303N	1

ENGINEERING DRAWING NUMBER:
00017697

UNLESS OTHERWISE SPECIFIED
DIMENSIONS ARE IN INCHES
TOLERANCES
DECIMALS: X ± .1
 XX ± .01
 XXX ± .001
 XXXX ± .0005

ANGULAR: X ± 0.5
THIRD ANGLE PROJECTION

DESIGNED BY:
BUMPHREY
CREATION DATE:
3/20/2013

DETAILED BY:
BUMPHREY
DETAILED DATE:
2/26/2018

LAST REVISED BY:
bumphrey
LAST REVISED DATE:
2/26/2018

MATERIAL:

HYDRA POOLS

TITLE: LAYOUT, 20' X 40', LAGOON, LEFT, 4' DEEP, FLAT BOTTOM, HS311N, LIGHT, 2-1084, 3-INLET, 600 SERIES

PART NUMBER: **00017697**

SCALE: 1:128
SHEET: 1 OF 4

A

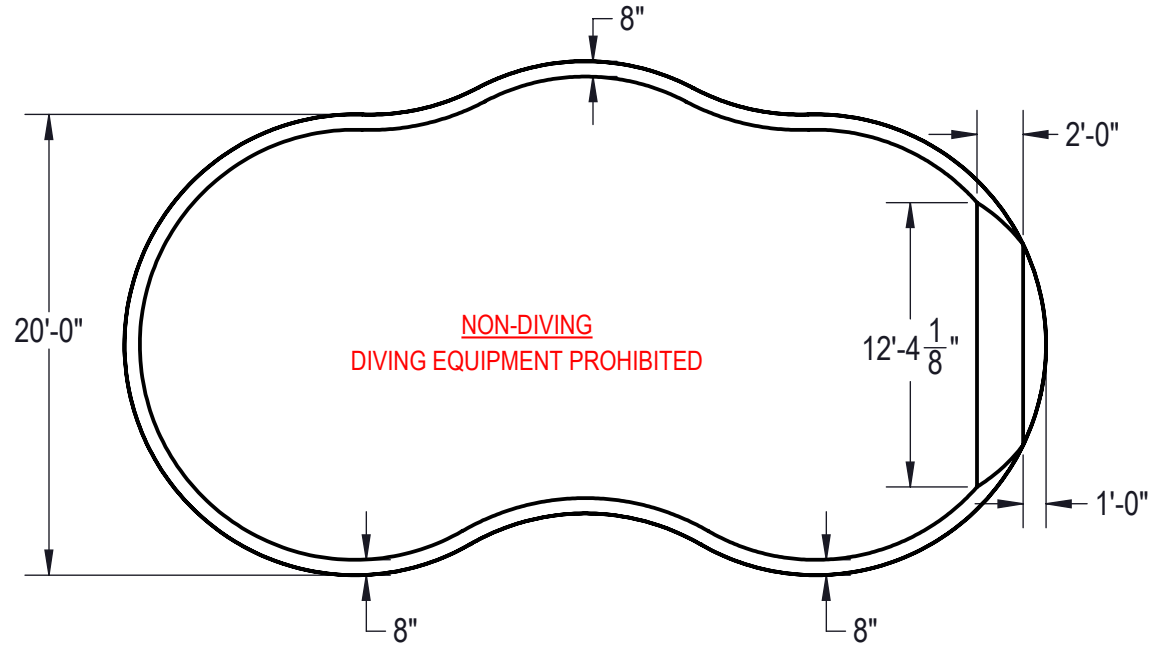
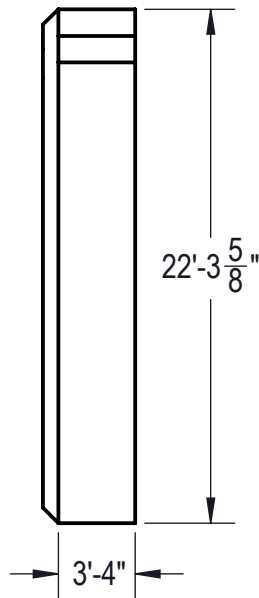

Area: 708.82ft ^2
Perimeter: 104.53ft
Volume = 20975 US gallons

NOTES:

1. THESE ARE FINISHED DIMENSIONS READY FOR THE LINER.
2. DIMENSIONS ARE FROM INSIDE POOL PANELS.
3. ROPE AND FLOAT ASSEMBLY SHOULD BE INSTALLED IN ACCORDANCE WITH CURRENT ANSI/ASPS/ICC REGULATIONS
4. HYDRA LINER TRACK FOR STEPS IS INSTALLED WITH THE BARB FACING THE RISER WALL ON THE STEP.

EXCAVATION NOTES:

5. ROUGH EXCAVATION SHOULD BE 2" DEEPER IN EACH INSTANCE.
6. SOIL TO HAVE MINIMUM BEARING CAPACITY OF 1500 PSF.
7. LOCATE TOP OF POOL AT LEAST 6" ABOVE THE SURROUNDING LAND ELEVATION.
8. SEE "OVER DIG DETAIL" FOR EXCAVATION AROUND POOL.
9. FILL VOIDS UNDER BASE OF PANELS AND TAMP WELL.
10. BACK FILL WITH NON-EXPANSIVE MATERIAL.
11. FOLLOW ALL CURRENT ANSI / APSP / ICC GUIDELINES FOR RESIDENTIAL POOLS

IMPORTANT NOTES:

THIS DOCUMENT IS FOR ILLUSTRATIVE PURPOSES ONLY. THE DEALER OR CONTRACTOR WHO SELLS OR INSTALLS YOUR POOL IS AN INDEPENDENT CONTRACTOR AND IS NOT AN AGENT OF THE MANUFACTURER. THE CONSTRUCTION METHODS ILLUSTRATED HERE ARE SUGGESTIONS AND APPLY ONLY TO NORMAL GROUND CONDITIONS. THERE MAY BE ADDITIONAL PRECAUTIONS AND/OR METHODS OF CONSTRUCTION. PROPER INSTALLATION IS THE RESPONSIBILITY OF THE DEALER/BUILDER/CONTRACTOR.

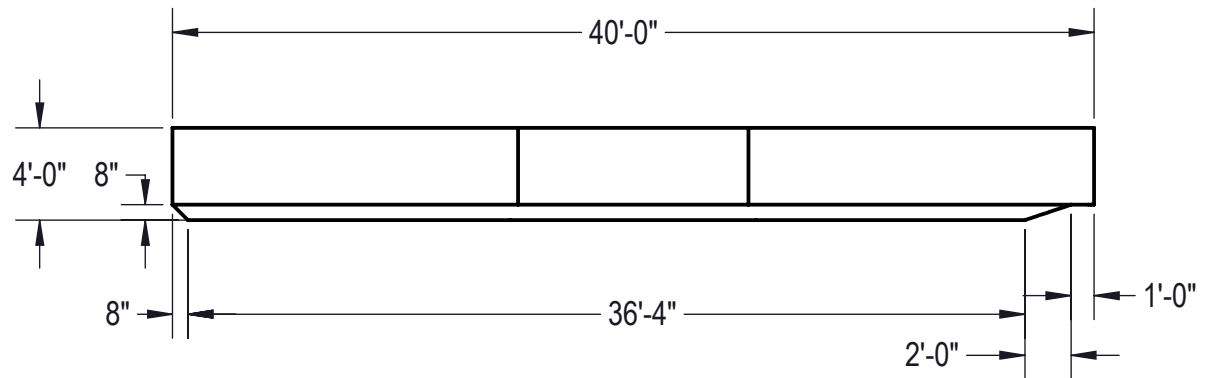

ENGINEERING DRAWING NUMBER: 00017697	WEIGHT: 175047.58 lbs	UNLESS OTHERWISE SPECIFIED DIMENSIONS ARE IN INCHES TOLERANCES DECIMALS: X ± .1 XX ± .01 XXX ± .001 XXXX ± .0005 ANGULAR: X ± 0.5 THIRD ANGLE PROJECTION 	DESIGNED BY: BUMPHREY	CREATION DATE: 2/15/2012	HYDRA POOLS	
	VOLUME: 79400270218.4		DETAILED BY: BUMPHREY	DETAILED DATE: 2/26/2018		
	COLOR: NA		LAST REVISED BY: bumphrey	LAST REVISED DATE: 2/26/2018	TITLE: LAYOUT, 20' X 40', LAGOON, LEFT, 4' DEEP, FLAT BOTTOM, HS311N, LIGHT, 2-1084, 3-INLET, 600 SERIES	
	HEAT TREAT: NA		MATERIAL: Water			
FINISH: NA					SHEET: 2 OF 4	
TEXTURE: NA						

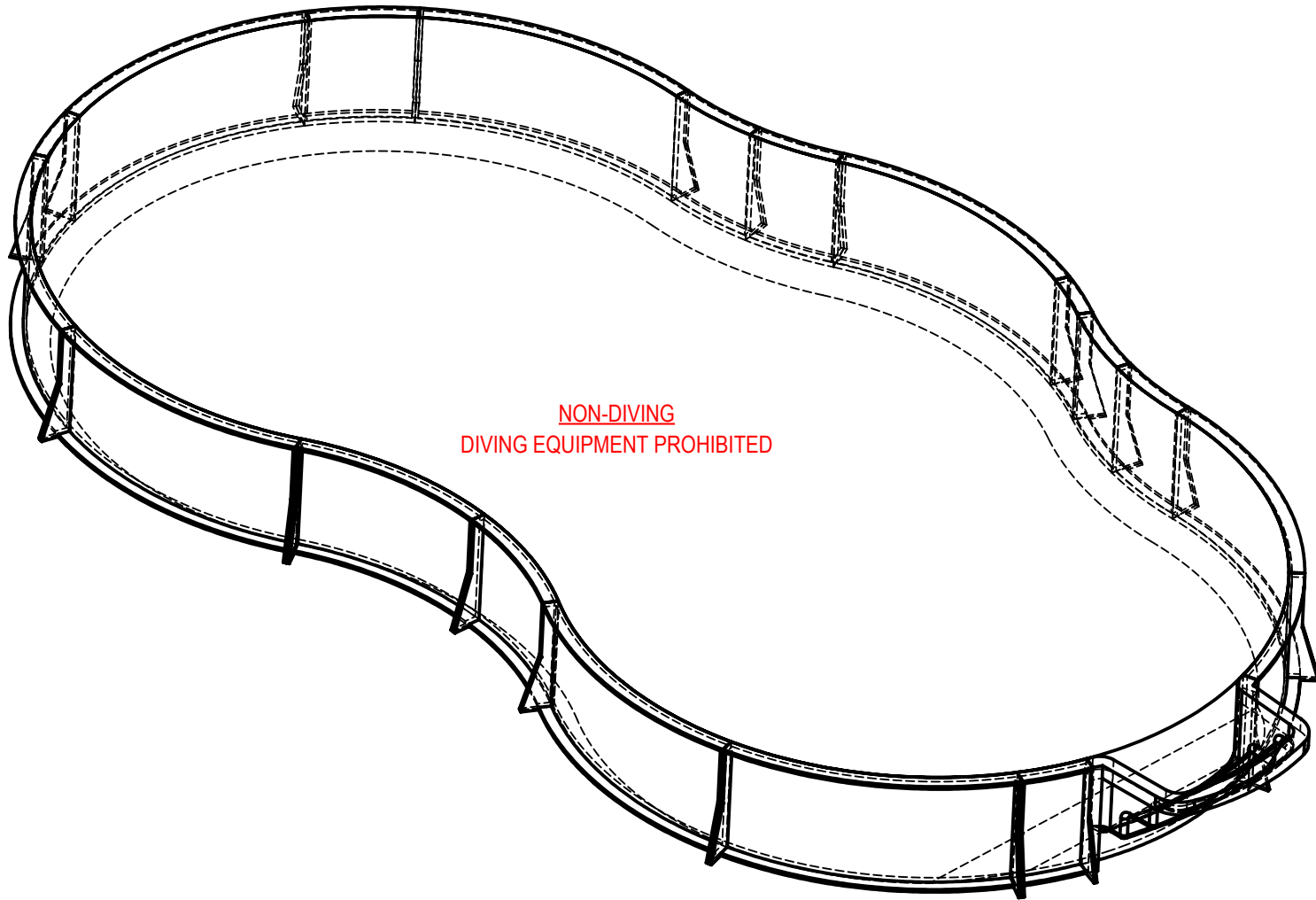

**NON-DIVING
DIVING EQUIPMENT PROHIBITED**

ENGINEERING DRAWING NUMBER: 00017697	WEIGHT:	UNLESS OTHERWISE SPECIFIED DIMENSIONS ARE IN INCHES TOLERANCES DECIMALS: X ± .1 XX ± .01 XXX ± .001 XXXX ± .0005 ANGULAR: X ± 0.5 THIRD ANGLE PROJECTION 	DESIGNED BY:	CREATION DATE:	HYDRA POOLS TITLE: LAYOUT, 20' X 40', LAGOON, LEFT, 4' DEEP, FLAT BOTTOM, HS311N, LIGHT, 2-1084, 3-INLET, 600 SERIES PART NUMBER: 00017697	SCALE: 1:48 SHEET: 3 OF 4 A
	lbs		DESIGNED BY:	3/20/2013		
	VOLUME:		DETAILED BY:	DETAILED DATE:		
	Inch ³		BUMPHREY	2/26/2018		
	COLOR:		LAST REVISED BY:	LAST REVISED DATE:		
	NA		bumphrey	2/26/2018		
HEAT TREAT:	MATERIAL:					
NA						
FINISH:						
NA						
TEXTURE:						
NA						

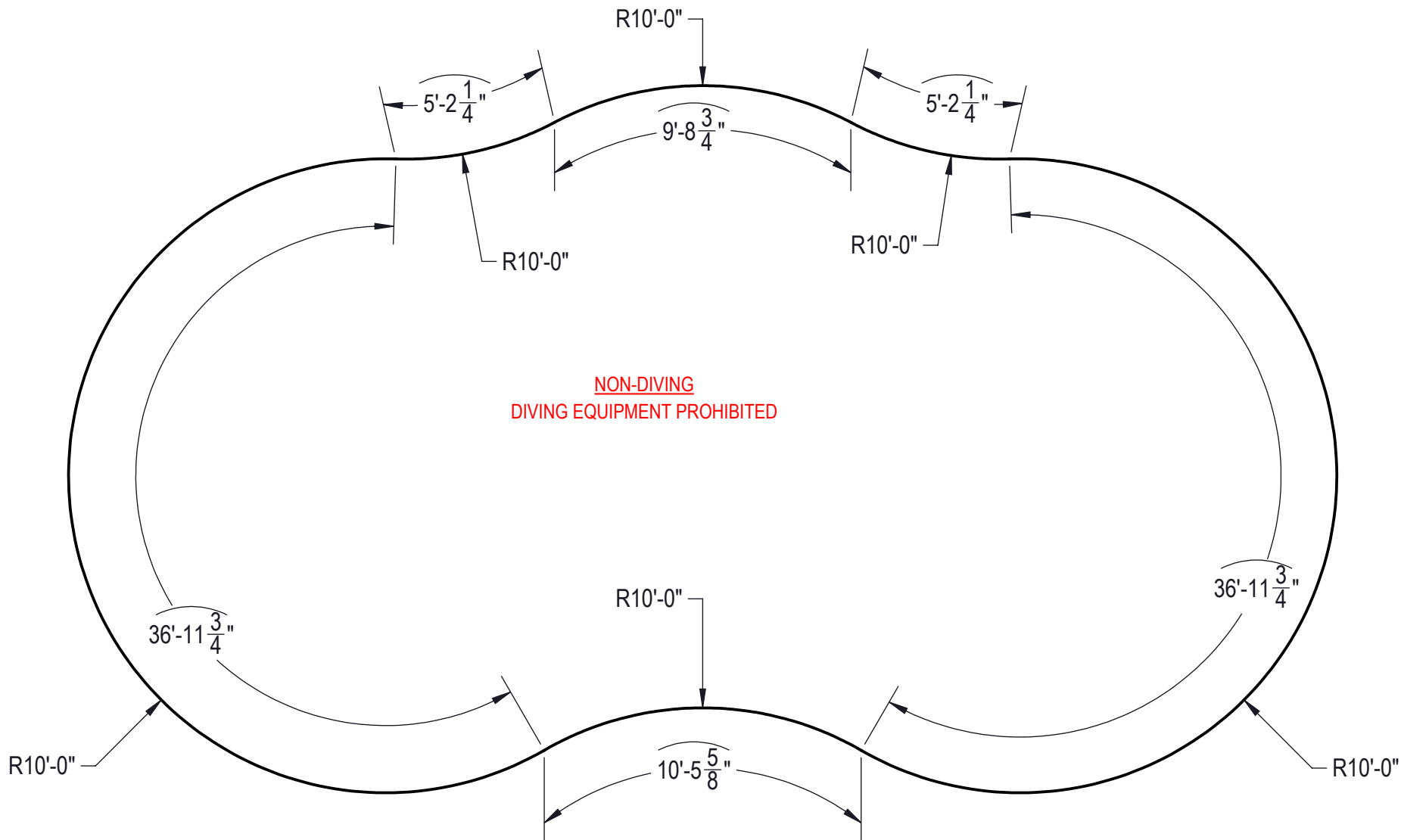

**NON-DIVING
 DIVING EQUIPMENT PROHIBITED**

ENGINEERING DRAWING NUMBER: 00017697	WEIGHT:	175047.58 lbs	UNLESS OTHERWISE SPECIFIED DIMENSIONS ARE IN INCHES TOLERANCES DECIMALS: X ± .1 XX ± .01 XXX ± .001 XXXX ± .0005 ANGULAR: X ± 0.5 THIRD ANGLE PROJECTION 	DESIGNED BY:	BUMPHREY	CREATION DATE:	2/15/2012	HYDRA POOLS			
	VOLUME:	79400270218.4		Detailed by:	BUMPHREY	Detailed Date:	2/26/2018				
	COLOR:	NA		Last Revised by:	bumphrey	Last Revised Date:	2/26/2018	TITLE: LAYOUT, 20' X 40', LAGOON, LEFT, 4' DEEP, FLAT BOTTOM, HS311N, LIGHT, 2-1084, 3-INLET, 600 SERIES			
	HEAT TREAT:	NA		MATERIAL:	Water						
	FINISH:	NA		PART NUMBER: <div style="font-size: 2em; font-weight: bold; text-align: center;">00017697</div>		SCALE:	1:48				A
	TEXTURE:	NA				SHEET:	4 OF 4				