

PoolWarehouse

1-800-515-1747 FAX: 888-491-1236
 sales@poolwarehouse.com

PLEASE RETURN THIS FORM VIA EMAIL OR FAX.
Vinyl-Over-Step Liner Form

CUSTOMER IS RESPONSIBLE FOR THE PROPER FIT!
 By the submission of this order the below named corporation and individual hereby authorize PWH and HYDRA POOLS to manufacture as a special order, a vinyl liner for an in-ground pool in accordance with the design and specifications which have been provided here within, and hereby acknowledge that PWH and HYDRA POOLS has not participated in either the design or formation of this liner and accepts full responsibility for the same, and further agrees to hold PWH and HYDRA POOLS harmless, that is, the below named corporation will pay in full or for any and all claims and expenses that may arise out of the design or use of this special liner.

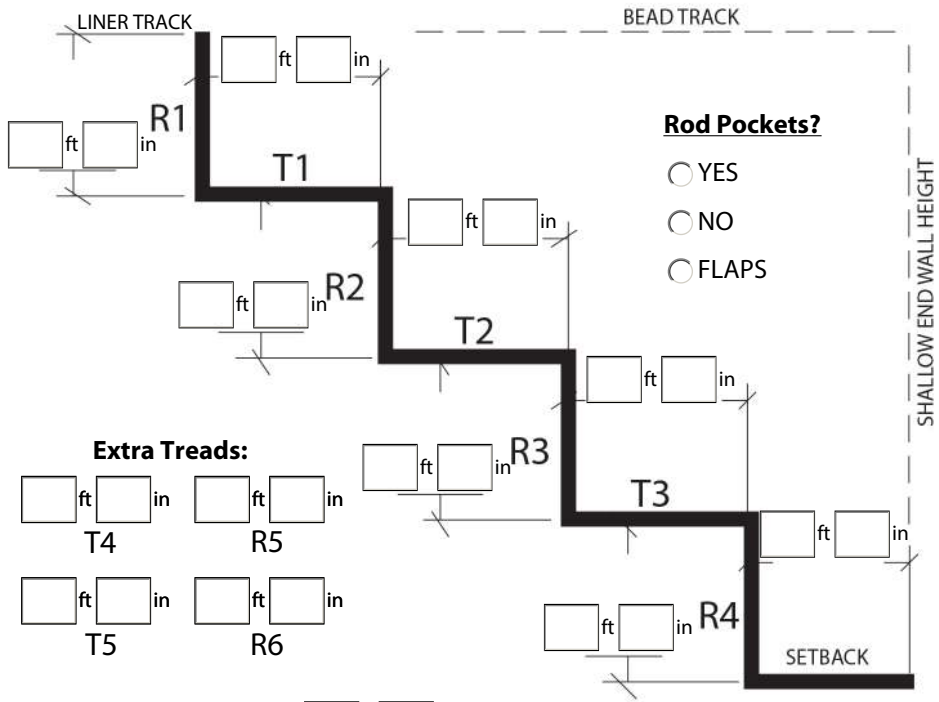

Rod Pockets?

- YES
- NO
- FLAPS

Extra Treads:

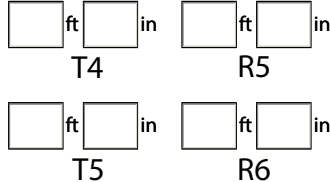

Setback: ft in FOR OUTSIDE PERIMETER STEPS 45° 90°

Corners: 6"Rad 90° Diag. _____ Step Width: ft in

PLEASE SELECT THE LOCATION OF YOUR STEP

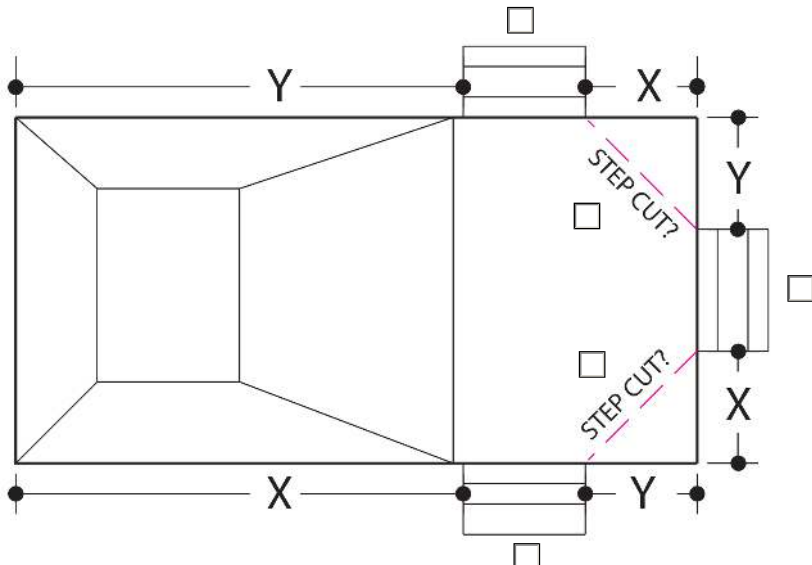

Name:

Address:

City: State:

Zip: Phone:

E-Mail:

SHIPPING INSTRUCTIONS

Name:

Address:

City: State:

Zip: Phone:

E-Mail:

Mark Box:

TEXTURE ALL OVER STEP

STEP BEAD LOCATION

- TREAD MEETS RISER
- TREAD MEETS WALL

CLOSEOUT SEAM LOCATION

COMPLETE DIMENSIONS

X ft in Y ft in

STEP MANUFACTURER

Notes

SOME POOLS ARE NOT BUILT TO MANUFACTURERS SPECS. IT IS IMPORTANT THAT YOU VERIFY THE DIMENSIONS

Hydra Pools, Inc. (hereafter "Hydra Pools") and its authorized distributors and dealers, as part of the swimming pool industry, encourage pool safety to prevent the risk of a pool owner, family member, or guest from suffering a severe or paralyzing injury or loss of life due to diving, jumping, or sliding into swimming pool water of any depth, particularly into shallow water. The dealer or contractor who installs your liner is an independent contractor and is not an agent of the manufacturer. Proper installation is the responsibility of the dealer/builder/contractor. Hydra Pools will produce the liner according to the dimensions, including water depth, you have provided only upon the following conditions. The undersigned pool owner recognizes that the pool design, depth, and dimensions pool owner has selected may not conform to some or all pool industry standards and may be a nonconforming type, and pool owner agrees: 1. To permanently remove any diving board if it exists prior to the installation of this liner. 2. To relocate any sliding board if necessary, prior to installation of this liner. 3. To defend, indemnify and hold Hydra Pools and its distributors and dealers harmless from any claims by anyone arising from injuries that may occur from the use of the pool containing this liner; 4. To prohibit those using the pool from head-first diving or sliding into the pool, and 5. In addition to abiding by the conditions above, pool owner will not allow use of the pool by unsupervised minors, persons who might be impaired, or anyone, including guests, which is inconsistent with this warning.

I UNDERSTAND THE ABOVE WARNING AND REQUIREMENTS, CERTIFY THAT I WILL ABIDE BY ALL CONDITIONS HERETO, AND REQUEST THAT HYDRA POOLS PRODUCE THIS LINER AS ORDERED.

YOU MUST SIGN, DATE, AND RETURN THIS FORM WITHIN 2 BUSINESS DAYS OR IT WILL NOT BE PROCESSED. POOL OWNER SIGNATURE

DATE

PoolWarehouse

HOW TO MEASURE YOUR POOL FOR AN INGROUND LINER

Measuring without entering the pool:

You will be able to measure **horizontally**, all of the bottom dimensions without entering or draining the pool. You can create your own simple measuring tool (an extended Plumb Line) that will take about 5 minutes to assemble and is used by pool professionals taking liner measurements.

Create an extended Plumb Line.

You will Need:

- Long straight pole (Vac Pole).
- String attached to end of pole
- Weight to attach to end of string
- Measuring tape

Hint: Measuring is always easier with someone to help. Only measure down to the nearest 1/4 of an inch.

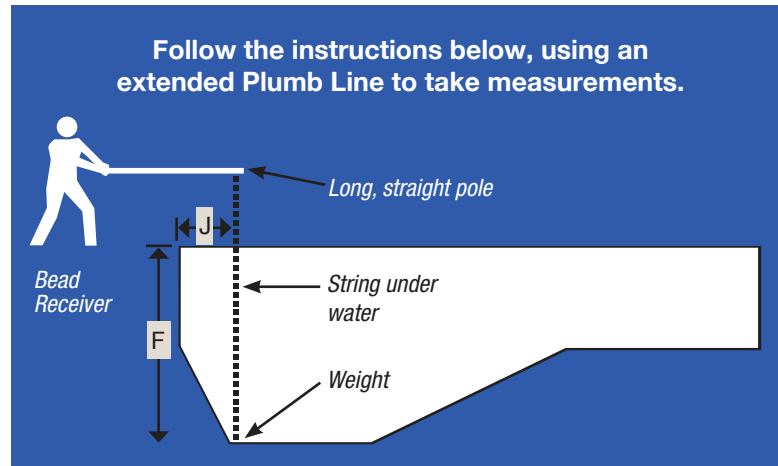

Horizontal Bottom Measurements:

You should “Plumb” for points that will achieve the desired measurements based on the bottom contour of the pool. To take measurement “F,” you would stand on one side of the pool and “Plumb” for a corner of the hopper, measuring the distance from the bead receiver to the end of where the weight is attached. To take measurement “J,” stand with the pole over the edge of the pool and the string vertical (allow no slack in the string), measure the distance from the edge of the pool to the end of the pole where the string is attached.

BEFORE MEASURING, KEEP THESE IN MIND

- 1: Do not ASSUME anything – measure it and check it thoroughly. Often, the pool may have slight variances from the original manufacturers specifications.
- 2: Not all pools are constructed with straight lines and sharply defined changes of plane. Therefore, please note any abnormalities.
- 3: Always provide exact measurements. The manufacturer will automatically make the liner slightly smaller than the dimensions you give, in order to allow the liner to stretch into place properly. DO NOT try to make extra allowances for stretch in your dimensions.
- 4: Actual pool measurements should be made even if the original pool plans are available due to the fact that slight variances may have occurred during construction.

LINER TYPES

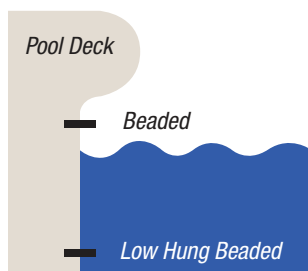

Standard Bead

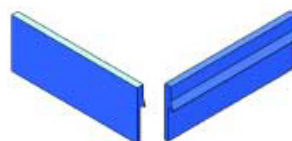

Esther Williams Bead

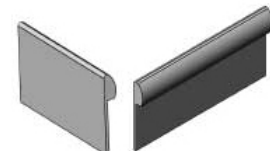

CORNER TYPES

Diagonal Corners

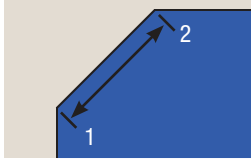

Square Corners

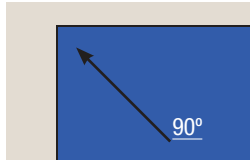

Radius Corners

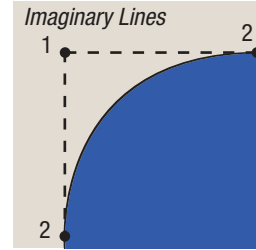

Note: If you have more than one type of corner on your pool (such as with a Lazy L) please include a sketch of pool indicating corner type and measurement.

POOL SHAPES

Rectangle

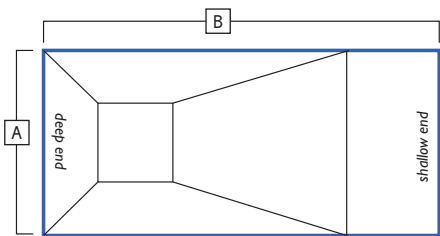

Oval

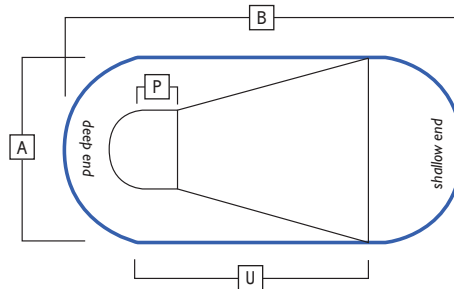

Lazy "L" Right

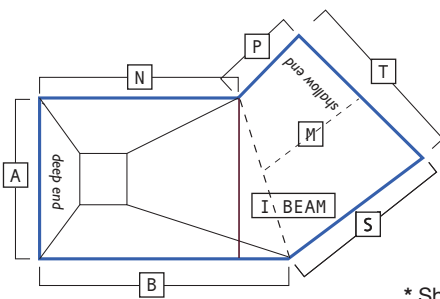

Lazy "L" Left

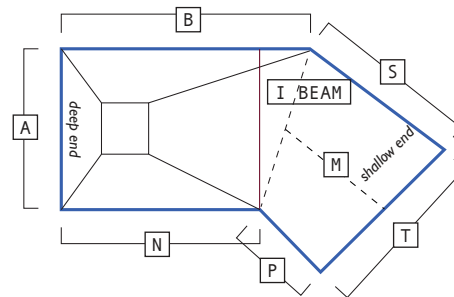

* Shallow End Breakline
 --- Follows I Beam
 — Perpendicular to B Wall

True "L" Right

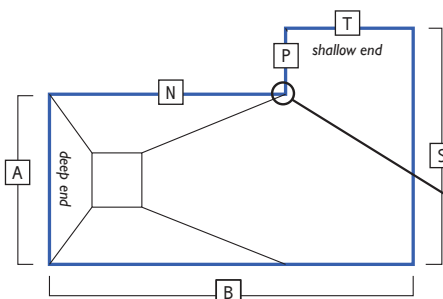

True "L" Left

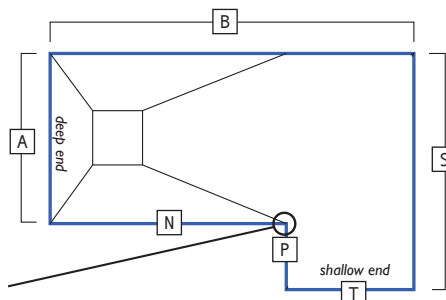

Reverse Corner
 Types:
 Square
 Radius
 Diagonal

ADDITIONAL POOL SHAPES

Grecian

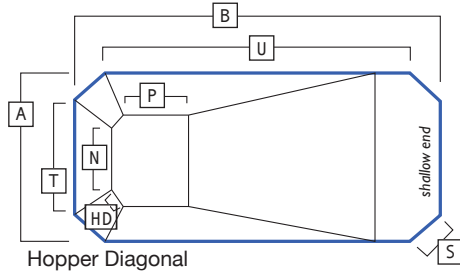

Jewel

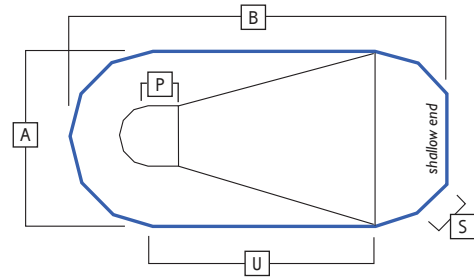

Single Roman

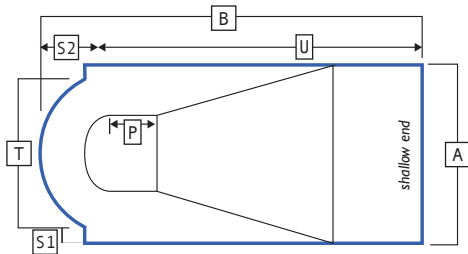

Double Roman

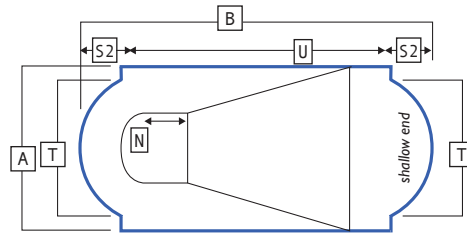

Octagon

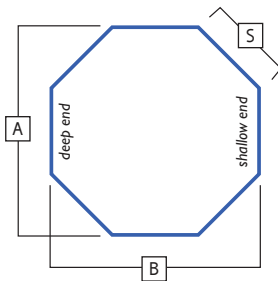

Round

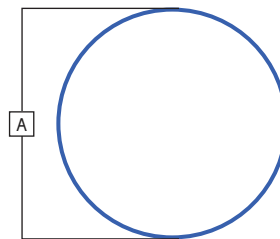

HOPPER PAD TYPES

Square

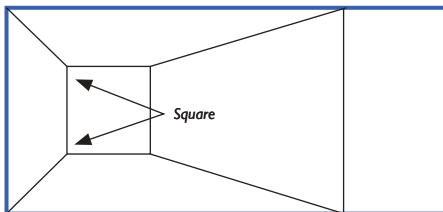

Radius

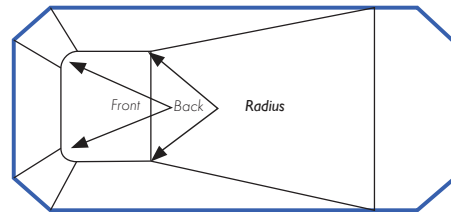

Diagonal

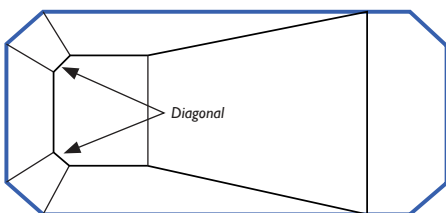

Oval

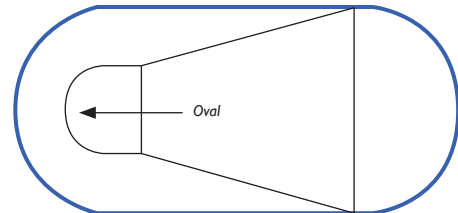

HOPPER TYPES

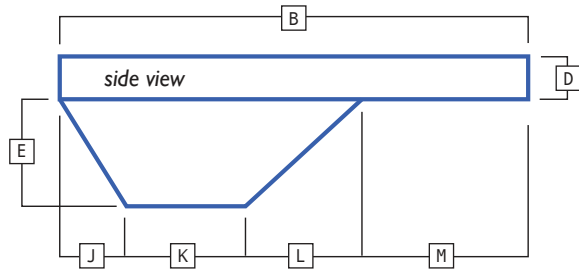

Standard Hopper

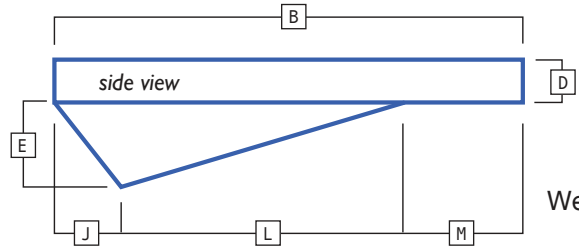
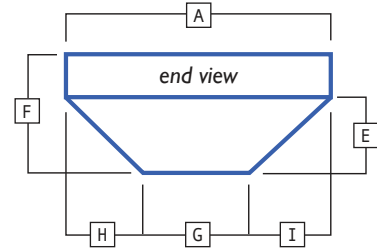

Wedge Hopper w/Shallow End

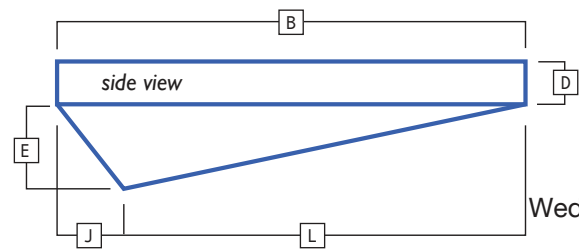
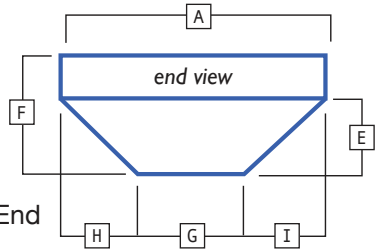

Wedge Hopper w/Constant Slope

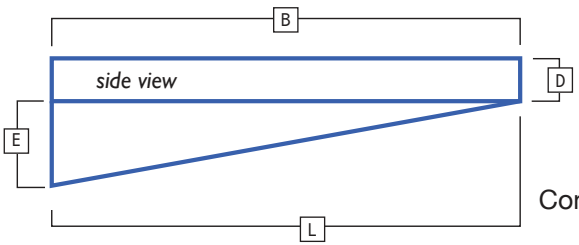
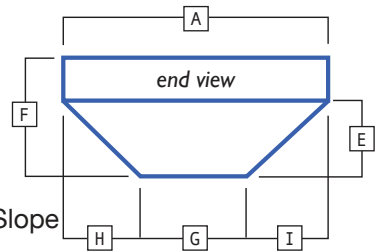

Constant Straight Slope Hopper

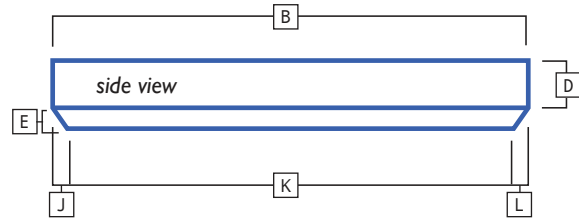
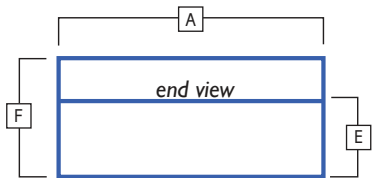

Cove Hopper

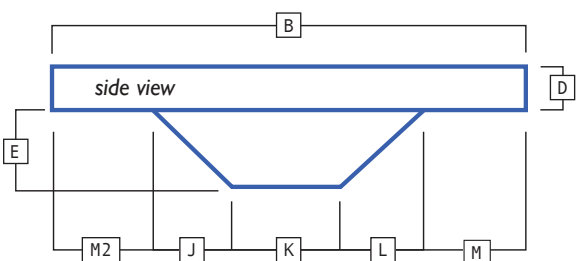
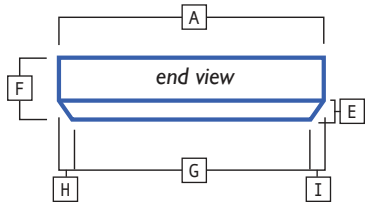

Sport Bottom Hopper

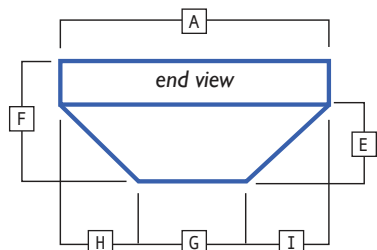

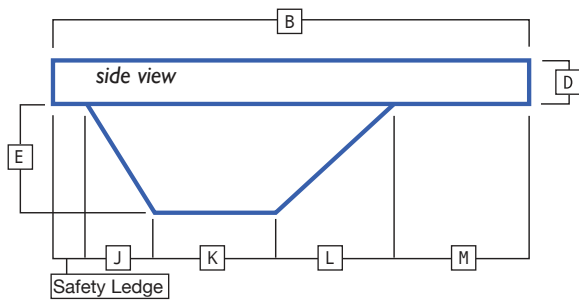

Safety Ledge Hopper

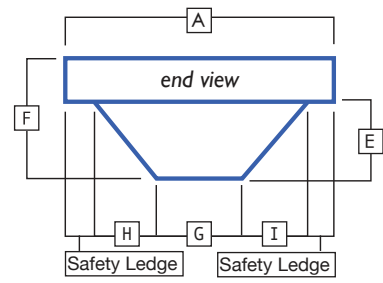

VINYL COVERED STEP POSITIONS

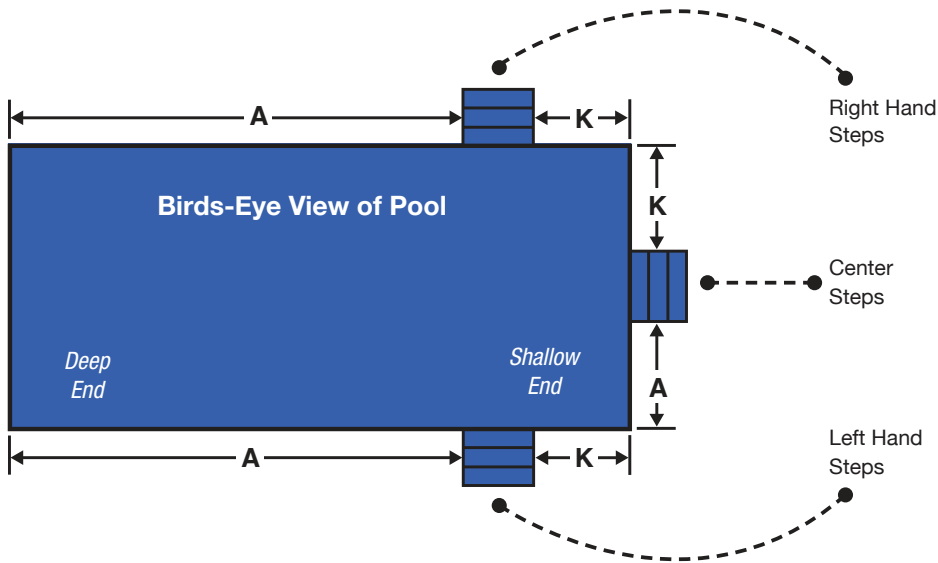

Use the straight side of the pool to draw an imaginary 'corners' on your pool. Then measure from 'corner' to the steps on each side.

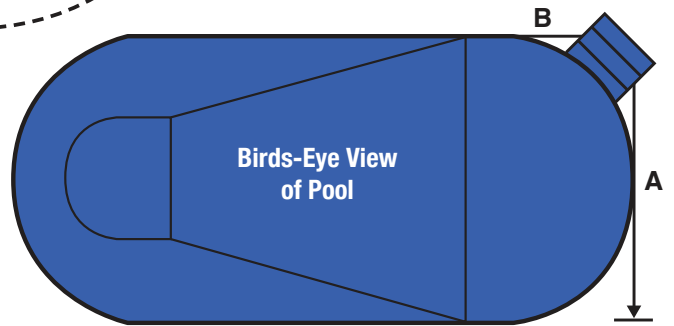

VINYL COVERED STEP SHAPES

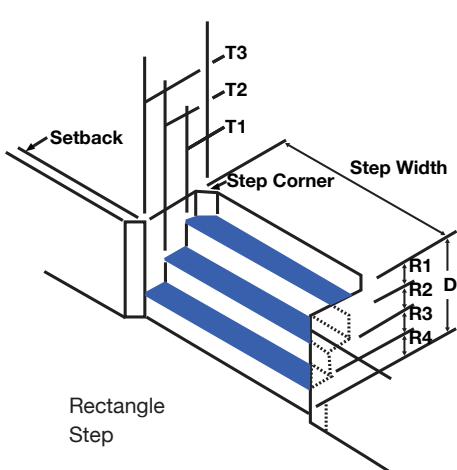

Rectangle Step

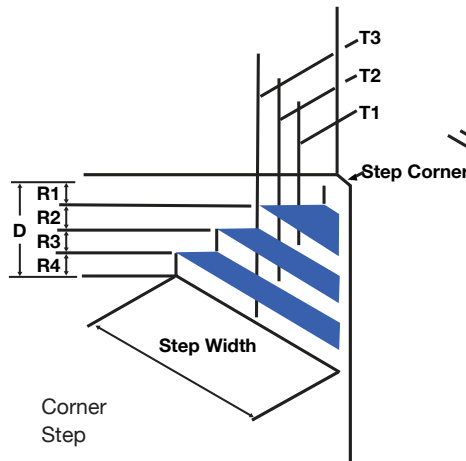

Corner Step

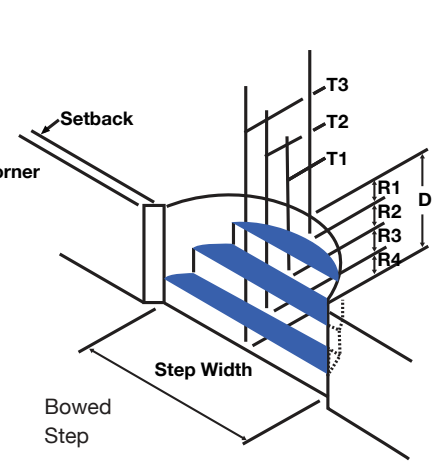

Bowed Step

CUSTOM LINER ABMEASURING

AB Measurements are required for freeform pools to match the unique curves of your pool. Start by sketch-ing a diagram of the pool on paper. Include location and detail of your pool deck and any non-removable obstructions, such as slides, dive stands, grab rails and ladders that lie within 18 inches of the pool edge. Pictures are required as well.

1. **Using chalk or masking tape to establish your AB plot line:** Start from 5' away from the widest pool edge, plot a line along the length of the pool. The line should not intersect the pool in any direction and should be **at least 2/3 the length** of the pool.

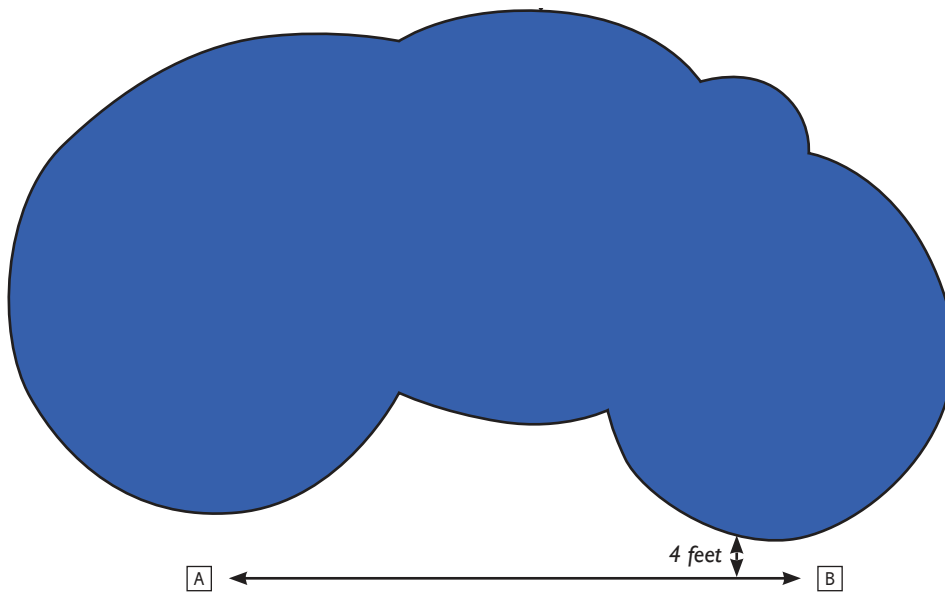

2. **Mark plot points around the perimeter of the pool approximately every 3 feet:** Mark your pool deck in roughly **3 foot intervals** around the pool perimeter, and numbering each point around the pool. Number all corners, rail locations (front and back of rails) or other obstructions within 18 inches of the pool edge. When tight curves, rocks, waterfalls or similar obstructions are encountered, mark at **one foot intervals**.

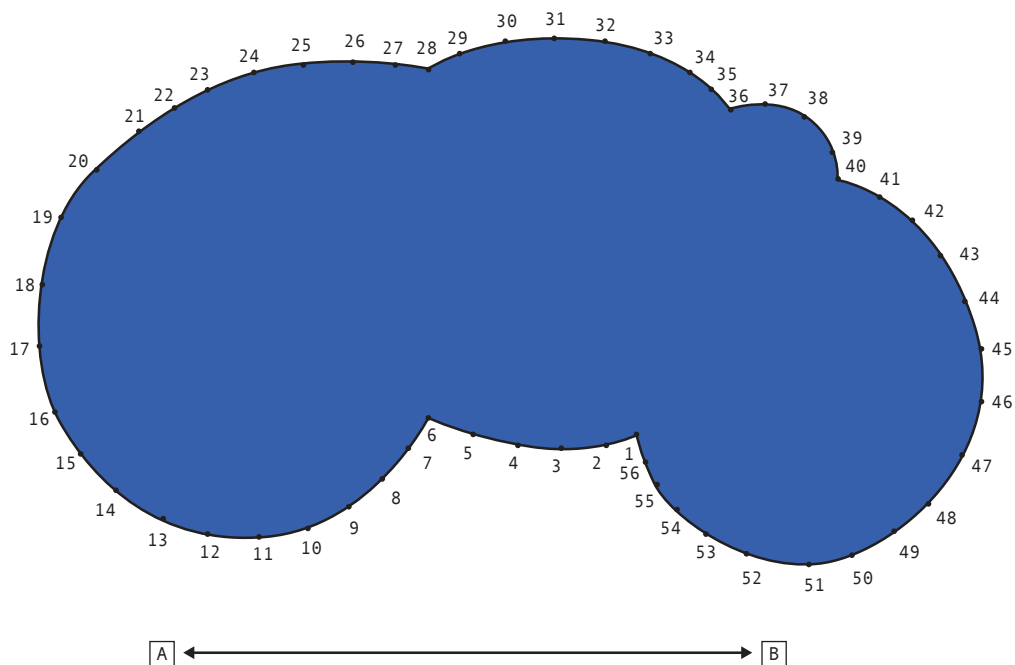

3. **Measure to each plot point from Point A:** Attach or have a partner hold one end of a tape measurer at Point A, measure to each point, starting at point one, and record in the corresponding box A1 on the measuring form. Continue measuring to each point around the pool perimeter and record each measurement. Repeat from Point B to each plot point in numerical order.

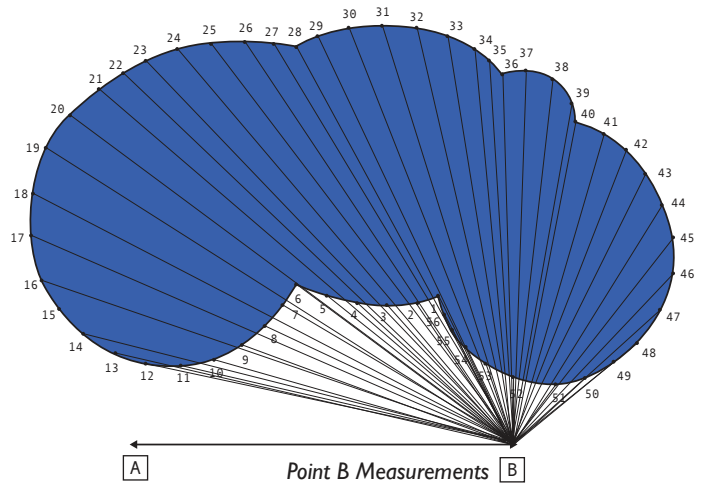
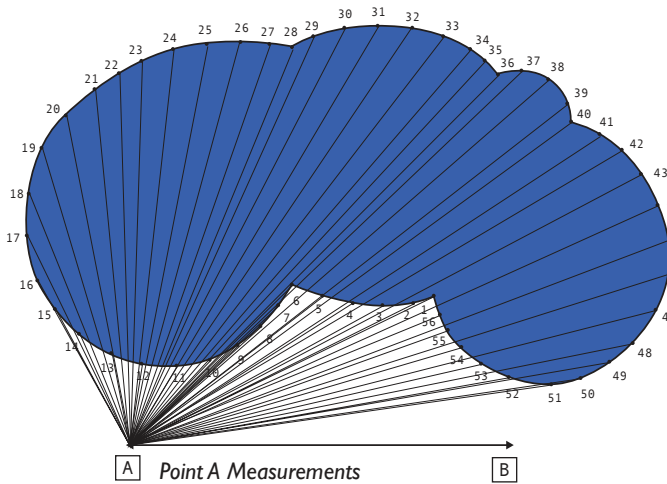

4. **Verify pool length and width:** Choose a numbered plot point in the shallow end, and a numbered plot point in the deep end, and record the measurement between the two points to represent overall pool length. Do the same across the widest point of the pool to represent the pool width. You may want to include a few width measurements for curvy pools with varied sections. Once completed, proceed on to the Hopper Style and measurements in the standard measurement form.

