

# *SunBriteTV*<sup>®</sup>

True Outdoor Television

## Operator's Manual



### Pro 2 Series 1K/4K

Model SB-P2-32-1K

SB-P2-43-1K

SB-P2-49-4K

SB-P2-55-4K

SB-P2-65-4K

## CA Prop65 Warning

---



**WARNING:** This product can expose you to chemicals including Nickel Oxide, which is known to the State of California to cause cancer. For more information go to [www.P65Warnings.ca.gov](http://www.P65Warnings.ca.gov).

## Recycling Programs

---

**For California, Connecticut, Hawaii, Illinois, Indiana, Maine, Maryland, Michigan, Minnesota, Missouri, North Carolina, New Jersey, New York, Oklahoma, Oregon, Pennsylvania, Rhode Island, South Carolina, Texas, Utah, Virginia, Vermont, Washington, Washington D.C., Wisconsin, and West Virginia Consumers Only:**

For the recycling of SunBrite brand TV's and other brand TV's, please contact customer service at 866-357-8688 for details. SunBrite does not charge a separate fee at the time of recycling and provides free shipping and free containers as part of our recycling mailback program.

If you are mistakenly billed by the shipping company for any services or fees on your recycling request, please contact customer service at 866-357-8688.



---

## SnapAV remote management

- Remote Firmware Updates  
OvrC notifies and provides integrators with the newest software updates when available, so they can solve problems and upgrade devices remotely.

# Important Safety Instructions

Dear SunBriteTV Customer:

Congratulations on the ownership of your SunBriteTV all-weather outdoor LCD TV, and welcome to the family of satisfied SunBrite customers. You are in great company, with thousands of homeowners and esteemed commercial facilities such as Yankee Stadium, Fenway Park, Disney World, and Sea World who have trusted us to deliver superior performance, lasting durability and the enjoyment of superb television viewing in the great outdoors.

Our products are designed to withstand the rigors of the outdoor environment and provide our customers with many years of optimum viewing, while delivering excellent picture and sound as well as the ease of use and convenience of conventional indoor TVs.

To ensure safety and long product life, please read the Important Safety Instructions and complete manual carefully before using the TV. If you have any questions about the installation procedures, please contact our qualified SunBriteTV Customer Support Team at 866-357-8688.

## IMPORTANT SAFETY INSTRUCTIONS

- 1) Read these instructions, and keep them for future use.
- 2) Heed all warnings and follow all instructions.
- 3) Do not block any ventilation openings. Install in accordance with the manufacturer's instructions.
- 4) Do not install near any heat sources such as radiators, heat registers, stoves, or other apparatus (including amplifiers) that produce heat.
- 5) Do not defeat the safety purpose of the polarized or grounding-type plug. A polarized plug has two blades with one wider than the other. A grounding type plug has two blades and a third grounding prong. The wide blade or the third prong are provided for your safety. If the provided plug does not fit into your outlet, consult an electrician for replacement of the obsolete outlet.
- 6) Protect the power cord from being walked on or pinched, particularly at plugs, convenience receptacles, and the point where the cord exits from the apparatus.
- 7) Only use attachments/accessories specified by the manufacturer.
- 8) Use only the cart, stand, tripod, bracket or table specified by the manufacturer, or sold with the apparatus. When a cart is used, use caution when moving the cart/apparatus combination to avoid injury from tip-over.
- 9) Unplug this apparatus during lightning storms.
- 10) Refer all servicing to qualified service personnel. Servicing is required when the apparatus has been damaged in any way, such as power-supply cord or plug is damaged, liquid has been spilled or objects have fallen into the apparatus, does not operate normally, or has been dropped.

PORTABLE CART WARNING



**WARNING: TV must be plugged into a GFCI receptacle. the rated residual operating current shall not exceed 30mA. TV and GFCI RECEPTACLE MUST BE INSTALLED NO LESS THAN 5 FEET FROM ANY BODY OF WATER (SUCH AS POOL OR SPA). Check local building codes for proper installation guidelines.**

**WARNING:** This unit is equipped with a 3-pin grounded plug. The plug will only fit into a grounded power outlet. This is a safety feature. If you are unable to insert the plug into the outlet, contact your electrician. Do not alter this plug, as this will defeat the safety feature.

**CAUTION:** THE POWER SUPPLY CORD IS USED AS THE MAIN DISCONNECT DEVICE, ENSURE THAT THE SOCKET-OUTLET IS LOCATED/INSTALLED NEAR THE EQUIPMENT AND IS EASILY ACCESSIBLE

**WARNING:** This product shall be connected to a mains socket outlet with a protective earthing connection.

**CAUTION:** TO PREVENT ELECTRIC SHOCK, MATCH WIDE BLADE OF PLUG TO WIDE SLOT, FULLY INSERT.

**WARNING:** FCC Regulations state that any unauthorized changes or modifications to this equipment not expressly approved by the manufacturer could void the user's authority to operate this equipment.

**NOTE TO CATV SYSTEM INSTALLER:** This reminder is provided to call the CATV system installer's attention to Article 820-40 of the National Electrical Code that provides guidelines for proper grounding and, in particular, specifies that the cable ground shall be connected to the grounding system of the building, as close to the point of cable entry as practical.

**WARNING:** To reduce the risk of fire or electric shock, do not expose the inside of this apparatus to rain or moisture.

**This product utilizes tin-lead solder..** Disposal of these materials may be regulated due to environmental considerations. For disposal or recycling information, please contact your local authorities or the Electronic Industries Alliance: [www.eia.org](http://www.eia.org).

**Disclaimer:** While SunBriteTV LLC intends to make this manual accurate and complete, we do not make claims that the information contained within covers all details, conditions or variations, nor does it provide for every possible contingency in connection with the installation or use of this product. The information contained in this manual may change without notice.

# Important Safety Instructions

**Cleaning Instructions:** See "Care of SunBriteTV" on page 39.



**Attachments:** Do not use attachments not specifically recommended by the manufacturer. Use of improper attachments can result in accidents.

**Power Source:** SunBriteTV must operate on a power source indicated on the specification label. If you are not sure of the type of power supply used in your home, consult your dealer or local power company. When using the TV outdoors, you must use a GFI-protected AC outlet with "in-use" waterproof cover, the rated residual operating current shall not exceed 30mA.

**Installation:** Do not place the product on an unstable cart, stand, tripod, table, or anywhere the unit is not permanently installed. Placing the product on an unstable place can cause the product to fall, resulting in potential serious personal injuries, as well as damage to the product.

**Precautions when Transporting the TV:** Carrying the television requires at least two people.

**WARNING:** DO NOT IMMERSE TELEVISION IN WATER OR OTHER LIQUID. DO NOT INSTALL TV WITHIN 5 FEET OF BODY OF WATER (SUCH AS SPA OR POOL).

 <b>CAUTION</b> RISK OF ELECTRIC SHOCK. DO NOT OPEN.		
<p>The lightning flash with arrowhead symbol, within an equilateral triangle, is intended to alert the user to the presence of uninsulated "dangerous voltage" within the product's enclosure that may be of sufficient magnitude to constitute a risk of electric shock to persons.</p>		
<p>The exclamation point within a triangle is intended to alert the user to the presence of important operating and maintenance (servicing) instructions in the literature accompanying the product.</p>		
<p><b>CAUTION:</b> TO REDUCE THE RISK OF ELECTRIC SHOCK, DO NOT REMOVE COVER (OR BACK), FROM THE TELEVISION, EXCEPT WHERE SPECIFIED IN THE MANUAL. NO USER-SERVICEABLE PARTS INSIDE. REFER SERVICING TO QUALIFIED SERVICE PERSONNEL.</p>		

## FCC Statement

This equipment complies with the limits for a Class B digital device, pursuant to part 15 of the FCC Rules. These limits are designed to provide reasonable protection against harmful interference in a residential installation. This equipment generates, uses, and can radiate radio frequency energy and, if not installed and used in accordance with the instructions, may cause harmful interference to radio communications. However, there is no guarantee that interference will not occur in a particular installation. If this equipment does cause harmful interference to radio or television reception, which can be determined by turning the equipment off and on, the user is encouraged to try to correct the interference by one or more of the following measures:

1. Reorient or relocate the receiving antenna.
2. Increase the separation between the equipment and receiver.
3. Connect the equipment into an outlet on a circuit different from that to which the receiver is connected.
4. Consult the dealer or an experienced radio/TV technician for help.

Modifications not expressly approved by the manufacturer could void the user's authority to operate the equipment under FCC rules. This device complies with part 15 of the FCC Rules. Operation is subject to the following two conditions:

1. This device may not cause harmful interference.
2. This device must accept any interference received, including interference that may cause undesired operation.



## IMPORTANT SAFETY PRECAUTIONS.

- If an outside antenna is connected to the television equipment, be sure the antenna system is grounded so as to provide some protection against voltage surges or built-up static charges. Section 810 of the National Electrical Code provides information with respect to proper grounding of the mast and supporting structure, ground of the lead-in wire to an antenna discharge unit, side of grounding conductors, location of antenna discharge unit, connection to grounding electrodes, and requirements for the grounding electrode.
- For protection of the television equipment against direct lightning strikes, refer to NFPA 780 and CAN/CSA-B72-M87 (R2003) for additional requirements.

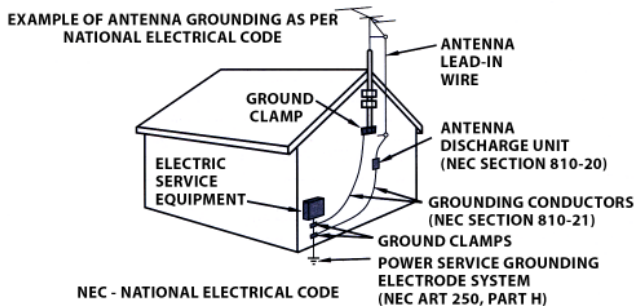

- For added protection for this television equipment during a lightning storm, or when it is left unattended and unused for long periods of time, unplug it from the wall outlet and disconnect the antenna. This will prevent damage to the equipment due to lighting and power-line surges.



- An outside antenna system should not be located in the vicinity of overhead power lines or other electric light or power circuits, or where it can fall into such power lines or circuits. When installing an outside antenna system, extreme care should be taken to keep from touching such power lines or circuits as contact with them might be fatal.





## Important Safety Instructions

---

**Ventilation:** Adequate ventilation must be maintained to ensure reliable and continued operation and to protect the television from overheating. There must be at least 1.5" of space on all sides.

**Power cord protection:** The power cord must be routed properly to prevent people from stepping on it, or objects from resting on it. Check the cords at the plugs and product.

**Power source:** This product must operate on a power source specified on the specification label. If you are unsure of the type of power supply used in your home, consult your dealer or local power company.

**Do not let metal pieces or objects** of any kind fall into the television from ventilation holes. High voltage flows in the product, and inserting an object can cause electric shock and/or short internal parts.

**Do not mount SunBriteTV near** a motor or transformer where strong magnetism is generated. Images on the television will become distorted and the color irregular.

**Do not mount SunBriteTV near** heat sources such as radiators, heaters, stoves and other heat-generating products (including amplifiers).

**Do not submerge SunBriteTV in water:** The SunBriteTV will resist water exposure from normal rain, sprinklers, garden hoses, etc.; however, it is not designed to be submerged in water.

**Do not pressure-wash SunBriteTV:** SunBriteTV will resist water exposure from normal rain, sprinklers, garden hoses, etc.; However, it is not designed to withstand pressure washers, high-pressure water jets, or hurricane-type weather.

**Do not service SunBriteTV yourself:** Removal of the television screen cover may expose you to high voltage or other dangerous risks. Refer all servicing to a qualified service professional. Warranty will not be honored if you service the unit yourself.

**Repair:** If any of the following conditions occurs, unplug the power cord, and call a qualified service professional to perform repairs:

When power cord or plug is damaged.

When objects have fallen into the product.

If unit was submerged in water or pressure-washed.

When product does not operate properly as described in the operating instructions. Do not touch the controls other than as described in the operating instructions. Improper adjustments of controls not described in the instructions can cause damage, which can require extensive repair work by a qualified technician.

When the product has been dropped or damaged.

When the product displays an abnormal condition. Any noticeable abnormality in the product indicates that the product needs servicing.

**Replacement parts:** In case the product needs replacement parts, make sure that the service person uses replacement parts provided by SunBriteTV. Use of unauthorized parts can result in fire, electric shock and/or other danger.

**Safety checks:** Upon completion of service or repair work, ask the service technician to perform safety checks to ensure that the product is in proper operating condition.

# Table of Contents

---

Important Safety Instructions .....	2
Table of Contents .....	5
Supplied Accessories .....	6
TV Installation	
Choose a Location for the TV .....	7
Rear Panel Internal Connect Source .....	8
Rear Panel Connection Diagrams .....	9
Side Panel and Front Panel Controls .....	18
Remote Control Guide .....	20
On-Screen Display Controls .....	21
Adjusting On-Screen Displays	
Channel Menu .....	25
Picture Menu .....	27
Sound Menu .....	28
Time Menu .....	29
Lock Menu .....	30
Option Menu .....	31
Media Menu .....	35
Information Menu .....	37
Troubleshooting .....	38
Care of SunBriteTV - Filter cleaning .....	39
Specifications .....	40
Features Information and Instructions .....	45
Extreme Climate Warning .....	45
Programming Other Manufacturers' Universal Remote Control Devices .....	44
SunBriteTV Pixel Quality Policy .....	45
Appendix A - RS232 Cable Pinout .....	46
Ir Emitter Installation .....	46
Appendix B - RS232 Control Codes .....	47

## Supplied Accessories

---

### Unpacking

After unpacking the SunBriteTV television, please make sure that the following items are included in the carton and that they are in good condition. If items are damaged or missing, contact your dealer immediately.

SunBriteTV LCD Television  
Remote Control with Batteries

Operator's Manual



Pro 2 Series Outdoor TV



Quick Start Guide



Remote Control

### Choose a Location for the TV

***Important: The TV must be installed at least 5 feet from pool, spa, or other body of water.***

The TV should be installed so the screen is not facing direct sunlight, or can be easily turned away from direct sunlight.

Ideal placement is in an area where the TV is shaded by trees, landscape and/or structures, or under a patio cover or gazebo.

Remember that the position of the sun changes during the day, as seen in the drawing at right. This means that the quality of the picture will change during the day. If you intend to install the TV in areas where direct sunlight will reach it, it's best to position the TV for optimum performance during the time of day when you do most of your TV watching.

If the sun shines directly on the screen for long periods of time, dark areas may develop on the screen. This is a normal reaction for the LCD panel, and will not cause damage to the screen. Either turn the screen away from the sun, or apply shade to the TV, and the dark areas will quickly disappear.

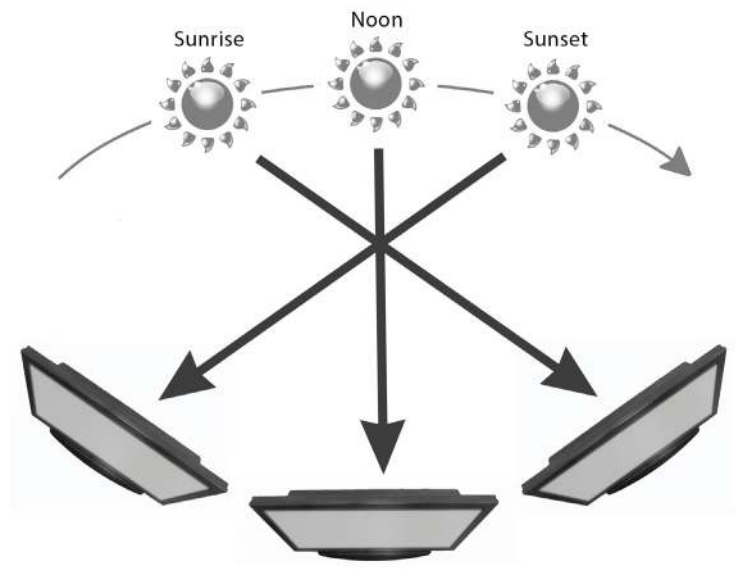



## TV Installation – Rear Panel Internal Connect Source - Cable routing

**WARNING: Do not connect the power source before making connections.**

### Internal Connect Source through the cable access door.

The Internal Connect Source allows you to easily connect to the Audio, Video, VGA, HDMI, Audio Out, and RF connectors. The internal connect Source are inside the cable cover located on the back of the unit (Figure1).

1. Unscrew the two Thumb Screws (Figure1), and pull the cover towards you.
2. Route the cables to the proper inputs, and place the cable cords over the Rubber Sealing Gasket on the bottom of the cable access opening(Figure 2).
3. Be sure the cables are routed past the indentation on the bottom of the door. Cable cannot be routed through the top and side of the rubber sealing gasket. (Figure 3).
3. Close the cover. Route the cables as shown to provide a drip loop below the door. This will prevent water from dripping down the cord and possibly entering the door area.
4. Press firmly on the cover, and screw the Thumb Screws tightly (Figure4).

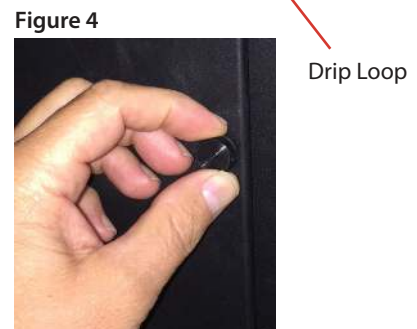
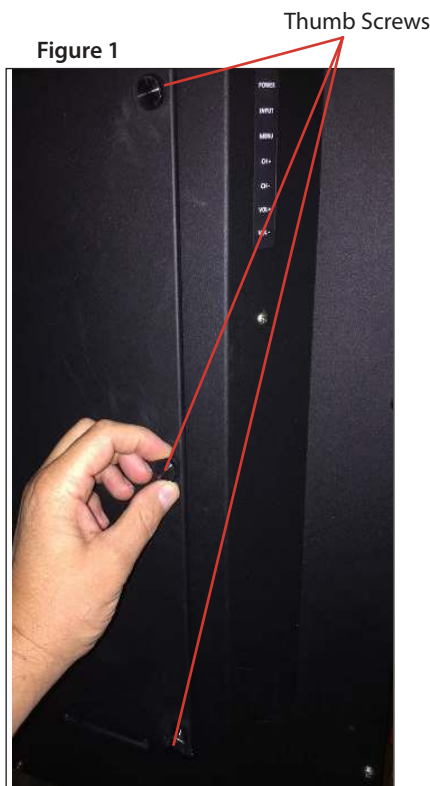

**Warning: Do not route cable from the top or sides of the cable access door. This will prevent a proper seal of the cable compartment and will void your warranty.**

## TV Installation - Connecting the Power Cord

Do not connect power cord until all cable connections have been made. Connect the power cord to a GFCI, the rated residual operating current shall not exceed 30mA, protected AC outlet with an "in-use" waterproof cover.

**WARNING: TV AND GFCI RECEPTACLE, the rated residual operating current shall not exceed 30mA, MUST BE INSTALLED AT LEAST 5 FEET AWAY FROM STANDING WATER , SUCH AS (BUT NOT LIMITED TO) A POOL OR SPA. BE SURE TO CHECK LOCAL ELECTRICAL CODES AND COMPLY WITH THEIR LOCAL STANDARDS.**

# TV Installation – Rear Panel Connections

## Connections

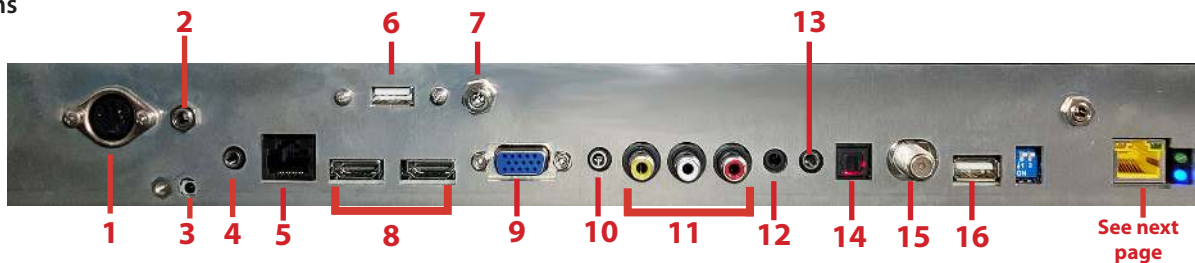

1. **5 pin din jack** - SunBriteTV optional speaker bar connection output.
2. **Direct IR input 3.5mm Jack**
3. **IR WINDOW** - Rear IR receiver, allows IR emitter to be installed inside the cable compartment.
4. **RS232 - 3.5mm Stereo Jack** - For remote control using RS232 commands.
5. **Ethernet- Network Connection** - IP Control.

Warning: Connect a network connection with an active connection to a ethernet switch.

6. **USB power port** - 5vdc @ 3.5a Auxillary power supply (Power only - no data)
7. **1.3mm Power Jack** - 5vdc @ 3.5a Auxillary power supply
8. **HDMI 1 & 2** - Connects to devices that use HDMI cables such as Blu-ray or HD DVD player or HD cable / satellite set-top box. This connection port receives pure digital audio and high definition signal through one single cable. This port also can accept a HDCP video device for video or PC for monitor display usage. Use the SOURCE button to select HDMI1 on your MAIN SOURCE to view this connection. Please note: when using HDMI, your sound signal must be PCM for the TV to decode digital audio. When using this source for PC display, you may have to connect the audio cable to VGA Stereo Input for audio.
9. **VGA** - This connection port connects to a PC for video using VGA cable. Be sure to connect your audio cable to the VGA Stereo input if you require sound out of the VGA video source. Use the SOURCE button to select PC on your MAIN SOURCE to view this connection
10. **VGA STEREO INPUT** - This connection 3.5mm jack provides audio to the TV when using a PC or a DVI video device. Use a 3.5mm mini-jack audio cable (headphone jack) to provide audio for a HDCP enabled DVI video device or PCs with VGA or DVI connection.
11. **AV (CVBS)** - Connects to devices that use legacy composite cables such as older VCR or camcorder or video game consoles. Connect the video portion with either the yellow connector. Use the SOURCE button to select AV on your MAIN SOURCE to view this connection.
12. **COMPONENT** - Requires use to 3.5mm to RCA cable. (not included) The RCA jacks are for DVD players or satellite/cable set-top boxes that use component cables. From left to right, connect green, blue and red for video, and then connect white for left channel audio, red for right channel audio. Use the Source Button to select Component to view this connection.
13. **ANALOG AUDIO OUT (Variable)** - Used to connect headphones, stereo receivers and amplified speakers via a 3.5mm headphone jack.
14. **DIGITAL AUDIO OUT** - This connection port is used for sending out audio signals to other audio devices such as stereo/surround sound receivers. The optical TosLink connector sends out either bit-stream or PCM digital sound signal to a home theater receiver with digital input
15. **ATSC/NTSC/QAM Coax input** – This connection is for digital or analog cable without the cable box or over-the-airwave antennas. The tuner is a hybrid tuner that tunes to both analog and digital channels. This connection uses coaxial RF cable. For over- the airwave digital stations please check <http://www.antennaweb.org>.
16. **USB SERVICE PORT** - Can be used for photo and MP3 media playback or firmware updates using a USB flash drive.

## TV Installation – Rear Panel Connections

---

### Connections continued

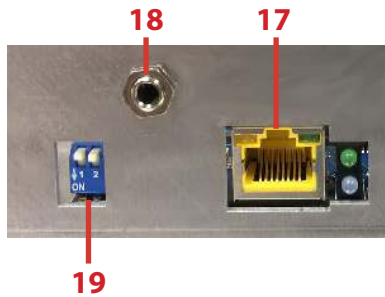

#### 17. HDBaseT - HD/UHD extender receiver.

Bottom Blue LED - indicates board power

Top Green LED - when lit indicates positive link to a HDBaseT transmitter

Left RJ45 Yellow LED - flashing = non-HDCP video transmitting/steady = HDCP video transmitting

Right RJ45 Green LED - Link from transmitter active

**Warning:** Do not connect HDBaseT to ethernet network based devices, damage to the HDBaseT receiver and/or the Ethernet network device may result.

**18. Emitter port** - Connect an emitter to control the SunbriteTV through the HDBaseT compatible transmitter which supports IR repeating.

**19. Option Switches**- reserved for future use. Switch settings do not effect the HDBaseT operation at this time.

---

## HDBase-T information

The Pro 2 Series 4K Ultra HD incorporates an HDBaseT receiver based on the SnapAV Binary B-520-RX-320.

A front IR receiver is incorporated into the design to extend the IR via the HDBaseT Transmitter and Receiver installation.

The IR repeater is dedicated to the integrated B-520-RX-320 and cannot be used with any other IR extender.

Refer to transmitter documentation for the support resolutions and color depth.

# TV Installation – Rear Panel Connections









## Connection Descriptions:

Port Quality & Name	Port Picture	Cable Used & Resolution	Devices that use this Port
<b>Best</b> HDMI (Digital HD/UHD)		<b>HDMI</b> 2160, 1080p, 1080i, 720p,720i, 480p,480i	Blu-ray DVD Player HD Cable or Satellite Set top box, PC.
<b>Best</b> HdbaseT (Digital HD/UHD)		<b>HdBaseT</b> 2160@30, 1080p, 1080i, 720p,720i, 480p,480i	Blu-ray DVD Player HD Cable or Satellite Set top box, PC Requires additional compatible HdbaseT extender transmitter
<b>Best/Fair</b> ATSC/NTSC (Digital HD)		<b>Coaxial RF</b> 1080i 720p,720i, 480p,480i	Antenna(Over the Air) or Digital Cable without the Cable set top box
<b>Best</b> VGA (HD Capable)		<b>VGA</b> 1920 x 1080 or lower	PC or MAC with VGA Connection.
<b>Better</b> Component (HD Capable)	 <b>Requires adapter shown below</b>	<b>Component</b> 1080i, 720p, 720i,480p,480i	DVD Player, Video Game Console, High Definition Cable or Satellite set top box.
<b>Fair</b> Composite (Non-HD)		<b>Composite</b> 480i only	Non High Definition Cable or Satellite Set-top box, VCR, Older Game Console, Camcorders.



Legacy component input, 3.5mm to RCA cable required for, not included  
SunBrite Part Number CBL-35MM-COMP

## Cable Descriptions:

Cable Name	Cable Picture
<b>HDMI</b>	
<b>Coaxial RF</b>	
<b>VGA</b>	
<b>Component (requires 3.5mm to RCA adapter, not included)</b>	 Red Green Blue
<b>Composite</b>	 Yellow
<b>1/8" (3.5mm) Audio Mini-plug</b>	 Green
<b>RCA Audio plug</b>	 Red White
<b>AC Power</b>	
<b>TosLink Optical Digital Audio plug</b>	

# TV Installation – Rear Panel Connections

## Switching Sources for Ports:

Your SunBrite TV offers several options when connecting your devices to the TV. The chart below will help you understand which source you switch to for each of the ports.

Port Picture	Cable Used	Source Name to Select
	<b>HDMI or HDMI-DVI</b>	<b>HDMI1 or HDMI2</b>
	<b>Category 5e Category 6 Ethernet Cable</b>	<b>HDBaseT</b>
	<b>COAXIAL RF (CABLE OR ANTENNA)</b>	<b>TV</b>
	<b>VGA (PC-MAC)</b>	<b>PC</b>
	<b>COMPONENT</b> <small>requires 3.5mm to RCA adapter, not included)</small>	<b>COMPONENT</b>
	<b>COMPOSITE</b>	<b>AV</b>

## CONNECTING TO AN ANTENNA



### Connecting to Digital Cable without Cable Box or Antenna

### Connecting to Cable or Antenna



1. Make sure the power to the TV is turned off.
2. Connect the Coaxial RF cable from your antenna or digital cable to the ATSC/NTSC port off the back of the TV.
3. Turn on the TV.
4. Select TV (Air) for antenna or TV (Cable) for digital cable from either your remote control's source button or source button on the right side of the TV.
5. Use the On-Screen Display to scan for channels.



1. Make sure the power of the TV is turned off.
2. Connect the Coaxial RF cable from your antenna or cable to the ATSC/NTSC port off the back of the TV.
3. Turn on the TV.
4. Select TV (Air) for antenna or TV (Cable) for cable from either your remote control's source button or source button on the right side of the TV.
5. Use the On Screen Display to scan for channels.

### Please Note :

1. Not all broadcasts are in High Definition (HD). Please refer to your local broadcasting stations for more information.
2. The TV's tuner is designed for HDTV therefore requires a stronger signal than normal TVs. If you cannot achieve that signal level with your antenna or cable, the TV might lose picture or sound.



# TV Installation – Rear Panel Connection Diagrams

## CONNECTING TO AN ANTENNA--(Continued)

### Connecting to Cable or Antenna through VCR

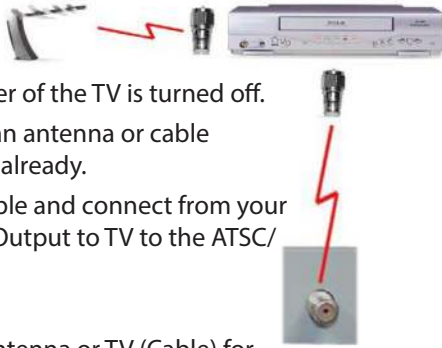

1. Make sure the power of the TV is turned off.
2. Make sure there is an antenna or cable connection to the VCR already.
3. Use a Coaxial RF cable and connect from your VCR's Antenna Out or Output to TV to the ATSC/NTSC port of your TV.
4. Turn on the TV.
5. Select TV (Air) for antenna or TV (Cable) for digital cable from either your remote control's source button or source button on the TV.
6. Use the On-Screen Display to scan for channels.

### Please Note :

1. Some VCRs must be turned On before its output will have a signal to the TV. Please consult your VCR manual for further reference.
2. Not all broadcasts are in High Definition (HD). Please refer to your local broadcasting stations for more information.
3. This model's tuner is designed for HDTV therefore it requires a stronger signal than normal TVs. If you cannot achieve that signal level with your antenna or cable, the TV might lose picture or sound.
4. This TV will turn off automatically if there's no signal present for more than 15 minutes.



## CONNECTING TO A DVD PLAYER

### Connecting with HDMI (Best)



1. Make sure the power of the TV and your DVD player is turned off.
2. Connect a HDMI cable to the HDMI port of your DVD player and the other end to the HDMI port off the back of your TV.
3. Turn on the TV and your DVD player.
4. Use the remote control's source button or the source button on the TV to switch to HDMI.

### Please Note :

1. Refer to the DVD player's manual to make sure the DVD player is configured to output correctly to the TV.
2. This TV does not decode Bit stream digital audio, so make sure the DVD is setup for PCM digital audio through HDMI.
3. If HDMI 1 is occupied, use HDMI 2 as your connection port.

### Connecting with Component (Better)



1. Make sure the power of TV and your DVD player is turned off.
2. With a Component Cable, connect the green connector to the DVD player and Component 1's green connector port on the TV.
3. Connect the blue color connector to your DVD player and Component 1's blue connector port on the TV.
4. Connect the red color connector to both your DVD player and Component 1's red connector port on the TV.
5. With an RCA Audio Cable, connect the white color connector to both your DVD player and Component 1's white connector port on the TV.
6. Connect the red color connector to both your DVD player and Component adapter connector port on the TV.
7. Component adapter connector port on the TV.
8. Turn on the TV and your DVD player. Use the remote control's source button or the source button on the TV to switch to component.



### CONNECTING TO A DVD PLAYER (Continued)



1. Make sure the power of the TV and your DVD player is turned off.
2. Obtain a Yellow Video Cable. Connect the Yellow Video connector to both your DVD player and Composite's Yellow Video connector port off the back of your TV.
3. Obtain a RCA Audio Cable. Connect the white color connector to both your DVD player and Composite's white connector port off the back of your TV.
4. Connect the red color connector to both your DVD player and Composite's red connector port off the back of your TV.
5. Turn on the TV and your DVD player.
6. Use the remote control's source button or the source button on the right side of the TV to switch to AV1 (CVBS).

Please note:

1. Reference the DVD player's manual to make sure the DVD player is configured to output correctly to the TV.
2. This TV will turn off automatically if there's no signal present for more than 15 minutes.

# TV Installation – Rear Panel Connection Diagrams

## CONNECTING TO A SATELLITE OR CABLE SET-TOP BOX

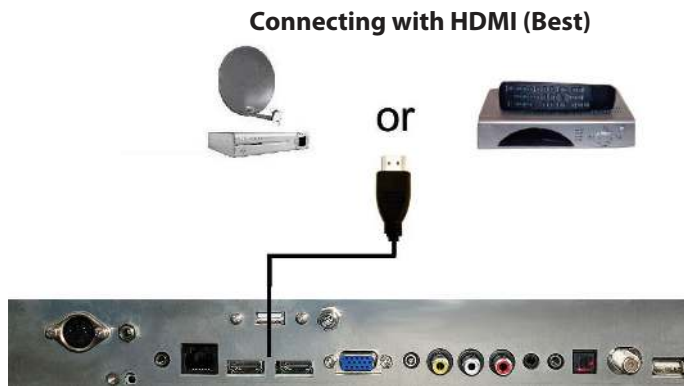

1. Make sure the power of the TV and your set-top box is turned off.
2. Connect a HDMI cable to the HDMI output of your set-top box and the other end to the HDMI port off the back of your TV.
3. Turn on the TV and your set-top box.
4. Use the remote control's source button or the source button on the right side of the TV to switch to HDMI 1.

**Please Note :**

1. Refer to the set-top box's manual, to make sure the set-top box is configured to output correctly to the TV.
2. If HDMI 1 is already occupied, use HDMI 1 as your connection port and switch source to HDMI 2.
3. This model supports SONY's universal remote code. If SunBriteTV is not listed, please look up SONY's codes in your universal remote's hand book.
4. This TV will turn off automatically if there's no signal present for more than 15 minutes.



1. Make sure the power of TV and your set-top box is turned off.
2. Obtain a Component Cable. Connect the green color connector to both your set-top box and Component 1's green connector port off the back of your TV.
3. Connect the blue color connector to both your set-top box and Component 1's blue connector port off the back of your TV.
4. Connect the red color connector to both your set-top box and Component 1's red connector port off the back of your TV.
5. Obtain a RCA Audio Cable. Connect the white color connector to both your set-top box and Component 1's white connector port off the back of your TV to the right side of your green, blue, red component connection.
6. Connect the red color connector to both your set-top box and Component 1's red connector port off the back of your TV to the right side of your green, blue, red component connection.
7. Turn on the TV and your set-top box.
8. Use the remote control's source button or the source button on the TV to switch to YPbPr1.

**Please Note :**

1. If Component 1 is already occupied, please use Component 2 is your connection port and switch to source YPbPr2.
2. Please refer to the set-top box's manual to make sure the set-top box is configured to output correctly to the TV.
3. This model supports SONY's universal remote code. If SunBriteTV is not listed, please look up SONY's codes in your universal remote's hand book.
4. This TV will turn off automatically if there's no signal present for more than 15 minutes.

### CONNECTING TO A SATELLITE OR CABLE SET-TOP BOX (Continued)



#### Connecting with Composite (Fair)

1. Make sure the power of the TV and your DVD player is turned off.
2. Obtain a Yellow Video Cable. Connect the Yellow Video connector to both your DVD player and Composite's Yellow Video connector port off the back of your TV.
3. Connect the white color connector to both your DVD player and Composite's white connector port off the back of your TV.
4. Connect the red color connector to both your DVD player and Composite's red connector port off the back of your TV.
5. Turn on the TV and your DVD player.
6. Use the remote control's source button or the source button on the right side of the TV to switch to AV1 (CVBS).

Please Note :

7. Refer to the set-top box's manual to make sure the set-top box is configured to output correctly to the TV.
8. This model supports SONY's universal remote code. If SunBriteTV is not listed, please look up SONY's codes in your universal remote's hand book.
9. This TV will turn off automatically if there's no signal present for more than 15 minutes.

# TV Installation – Rear Panel Connection Diagrams

## CONNECTING TO AN EXTERNAL AMPLIFIER OR AMPLIFIED SPEAKERS

### Connecting with Optical Digital (Best)



1. Make sure the power of the TV and your receiver is turned off.
2. Obtain a optical cable, connect it to your receiver's optical digital input and the optical audio out jack on the TV.
3. Turn on the TV and your receiver.

Please Note :

1. If you want pure digital stream for your receiver to decode, you must also configure the TV's Sound->SPDIF mode function. Make sure the option is on auto.
2. If your receiver is making static noises when receiving Bit Stream, you must use the PCM option instead.
3. Refer to the receiver's manual to make sure the receiver is configured to receive signals correctly from the TV

### Connecting with RCA Audio Analog (Good)



1. Make sure the power of the TV and your receiver is turned off.
2. Obtain a 3.5mm stereo/audio cable (if your amplifier audio connection requires RCA audio out jacks you will need to obtain an 1/8" Stereo Mini Plug to RCA adapter cable). Connect it to your receiver's audio input connection and the 3.5mm stereo/audio connection on the Analog Audio port on the back of the TV.

3. Turn on the TV and your receiver.

Please Note :

1. If you want pure digital stream for your receiver to decode, you must also configure the TV's OSD Sound->Digital Audio Out function. Make sure the option is on Bit Stream.
2. If your receiver is making static noises when receiving Bit Stream, you must use the PCM option instead.
3. Refer to the receiver's manual to make sure the receiver is configured to receive signals correctly from the TV

## CONNECTING TO A PC

### Connecting with DVI Digital (Best)



1. Make sure the power of the TV and your receiver is turned off.
2. Obtain a HDMI to DVI conversion cable; connect the DVI side of the conversion cable to the DVI output of your PC, and the HDMI side of the conversion cable to the HDMI port off the back of TV.
3. Obtain a 3.5 mm Mini-jack, connect to the audio out of your PC and the other end to the VGA Stereo Input Port.
4. Turn on the power to the TV and the PC.
5. From the remote control's source button, or the Source button from the TV's panel, switch to HDMI.

Please Note :

1. For the best picture, set your PC resolution to 1920 x 1080 at 60 Hz. Refer to the PC or graphic card manual for further instructions on how to set your resolution and refresh rate.
2. Refer to your PC manual for video output requirements of the video card.
3. The TV will turn off automatically if there's no signal present for more than 15 minutes.
4. If HDMI 1 is already occupied, use HDMI 2 as your connection port, and switch source to HDMI 2.

Continued on next page

## TV Installation – Rear Panel Connection Diagrams

---

### CONNECTING TO A PC (Continued)

#### Connecting with VGA Analog (Good)



1. Make sure the power of the TV and your PC is turned off.
2. Obtain a 15-pin D-Sub VGA cable, connect to the VGA output of your PC and the other end to the VGA port off the back of your TV.
3. Obtain a 3.5 mm Mini-jack, connect to the audio out of your PC and the other end to the VGA Stereo Input port.
4. Turn on the power of the TV and your PC.
5. Use the remote control's source button or the source button the TV to switch to VGA.

#### Please Note :

1. For the best results, please set your PC resolution to
2. 1920 x 1080 at 60 Hz. Refer to the PC or graphic card's manual for further instructions on how to set your resolution and refresh rate.
3. Refer to your PC manual for video output requirements of the video card.
4. The VGA port of the TV features a power saving mode which will automatically turn off the TV if there is no signal provided for more than 15 minutes.

# TV Installation - Connecting the Power Cord

## Connecting the Power Cord

**WARNING:**

TV AND GFCI RECEPTACLE MUST BE INSTALLED AT LEAST 5 FEET AWAY FROM STANDING WATER, SUCH AS (BUT NOT LIMITED TO) A POOL OR SPA, the rated residual operating current shall not exceed 30mA..

Connect the power cord after you have made connections to your video equipment.



Connect the power cord to a GFCI-protected AC outlet, the rated residual operating current shall not exceed 30mA. with "in-use" waterproof cover.

**Warning:** TV must be installed at least 5 feet away from standing water, such as (but not limited to) a pool or spa.

## Side Panel Controls



<b>Power</b>	Turn on the TV by pressing the button once. Press the button again to turn off the TV.
<b>Input</b>	This button switches between the different sources of the TV. When the On-Screen Display (OSD) is active, this button acts as the enter button and confirms the menu selection.
<b>Menu</b>	This button activates the OSD. If a sub-menu is active, pressing this button will return selection to the previous menu level.
<b>CH+/CH-</b>	These buttons change the TV channel up or down. If the OSD is active, these buttons function as up or down controls for the menu.
<b>Vol+ /Vol-</b>	These buttons increase or decrease the volume. If a sub-menu is active, pressing these buttons will move the selection left or right. If the OSD is active, Vol+/Vol- is used to select the highlighted options.

## Front Panel



IR Sensor  
LED power indicator  
Ambient light sensor



# Remote Control Guide

When programming a DirectTV, local cable universal remote control or Control system, you may find that SunBriteTV may not be on the list of TV manufacturers. If that is the case, your SunBriteTV supports SONY's TV universal remote code.



- ON** – Powers the TV On.
- OFF** – Powers the TV Off.
- 0~9** – Allows you to set the channels directly. To access a digital channel, use these buttons with the (-) button to switch channels.
- Dash (-)** – Insert the dash for selecting digital channels directly.
- R** – Returns to the previous channel.
- SLEEP**– Sets time for the TV to turn Off.
- CC**– Selects Closed Caption (CC only works under sources TV, AV1 and AV2.)
- V+** – Functions the Volume Up.
- V-** – Functions the Volume Down.
- MUTE** – Mutes the TVs Audio.
- MENU** – Opens / Exits the TV menu.
- CH+** – Functions the Channel Up.
- CH-** – Functions the Channel Down.
- MTS** – Selects stereo, mono, or second audio programming.
- ↑ / ↓ / ← / → /** – Allow you to navigate inside the OSD menu. They also function as CH+/- and Vol +/-.
- ↵** – Allows you to select functions inside the OSD menu, acts as the Enter button for OSD menu for changing channels.
- SOUND** – Selects various preset sound settings.
- EXIT** – Exits the TV menu.
- PICTURE** – Selects various preset picture settings.
- GUIDE** – Opens the current digital channel information guide.
- SOURCE** – Cycles between different input sources of the TV.
- INFO** – Shows current channel information, display input and resolution.
- ASPECT** – Selects different screen sizes
- FAVORITE** – Cycles the favorite channels.
- FAVORITE ADD / DEL** – Adds or deletes the current channel from the favorites channel list.

The following functions (*illustrated with bold squares on the remote*) are not applicable to this TV:

- SRS
- DNR
- ADD/Del
- BACK
- The **Picture In Picture/Picture On Picture** functions Audio, Video, Source, On/Off, Size and Pos
- FREEZE** – Freezes the TV picture. Press the button again to unfreeze the picture.

**SHIFT** – To select discrete inputs press and hold shift then press buttons 0-9

Shift-1	AV
Shift-2	NA
Shift-3	HDBaseT
Shift-4	USB
Shift-5	Component1
Shift-6	Component2
Shift-7	PC (VGA)
Shift-8	HDMI 1
Shift-9	HDMI 2
Shift-0	TV (Tuner)

## About the Water-Resistant Remote Control

The SunBriteTV Water-Resistant Remote Controller is engineered to give you many years of service.

“Water-resistant” means that the remote control can be in water for short periods of time without damaging the internal workings of the unit. It can be left in the rain, and even dropped in water, as long as it is retrieved quickly. ***The remote control should not be left floating in water.***

The functionality of the remote control is under warranty for one year. If the remote control malfunctions within the one-year warranty period, replace the batteries with new long-life alkaline batteries.

If the problem is not solved with new batteries, contact the SunBriteTV Customer Care Center. SunBriteTV will repair or replace the remote control at SunBriteTV's option.

If you have a warranty claim, contact the SunBriteTV Customer Care Center for further instructions.

866-357-8688

www.sunbrite.com

# On-Screen Display Functions

## Via the Remote Control

Adjusting the On Screen Display (OSD) from the Remote Control

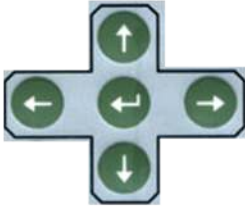

- This button is the UP direction in the OSD.
- This button functions as the DOWN direction in the OSD.
- This button functions as the left direction in the OSD.
- This button functions as the right direction in the OSD
- This button changes the channel in conjunction with the number pad and also functions as enter for selecting options in the OSD.

This button opens the OSD and also exits the OSD by going to the previous level of the OSD.

This button exits the OSD entirely.

## Via the TV Side Panel Buttons

Adjusting the On Screen Display from the TV Side Panel Buttons



**Menu** - This button opens the OSD

**CH + ▲** - This button changes the channel to a higher number and also functions the up direction of OSD buttons to move the cursor to the item to be selected.

**CH - ▼** - This button changes the channel to a lower number and also functions as down direction in the OSD

**Vol(+)** ► - This button increases the volume and functions as left direction in the OSD. If the OSD is active, use Vol+ and Vol- to select a choice.

**Vol(-)** ◀ - This button decreases the volume and functions as right direction in the OSD. If the OSD is active, use Vol+/Vol- to select a choice.

## On-Screen Display Menu

Your TV has been factory-set to plug-in and enjoy your programming. In the event you turn on the TV and get the message, "Please run Channel Auto Scan," press your remote's Menu button, press the Channel function and press Auto Scan.

Note: To run the Channel function, you must be in the TV Source. To access the TV source, click Input on the TV's side panel or Source button on the Remote Control. Press TV from the Input Select option.

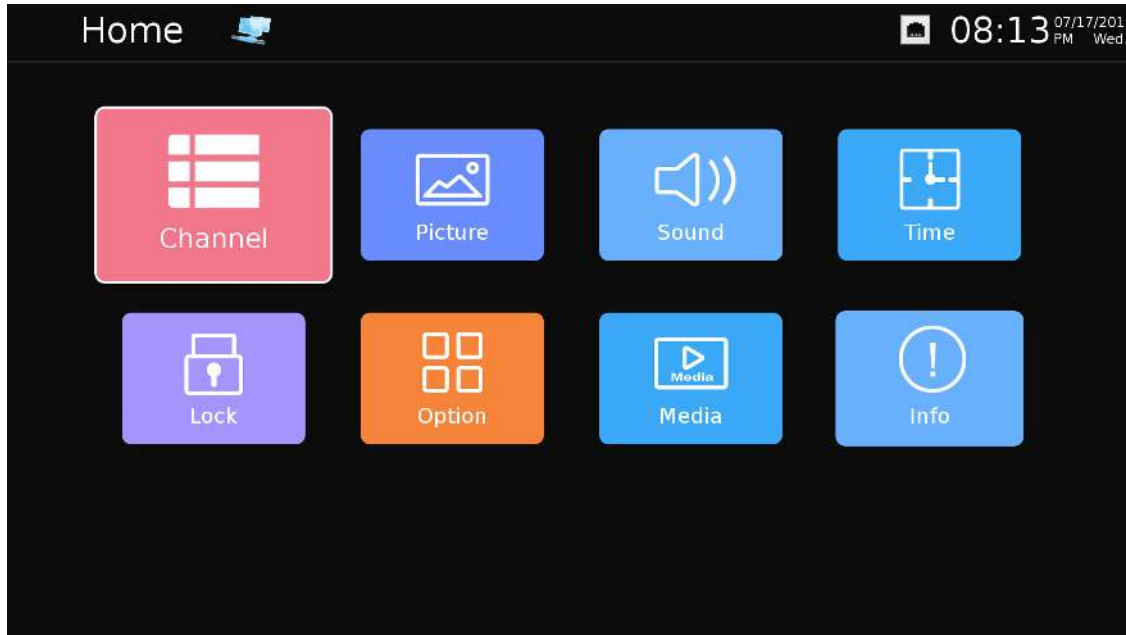

### Home Menu.

- Channel option only available when the TV input is selection.
- Network icon next to the right of home indicates an internet connect when blue, grey indicates no connection.
- Time will display when updated by the internet or over the air digital broadcast.

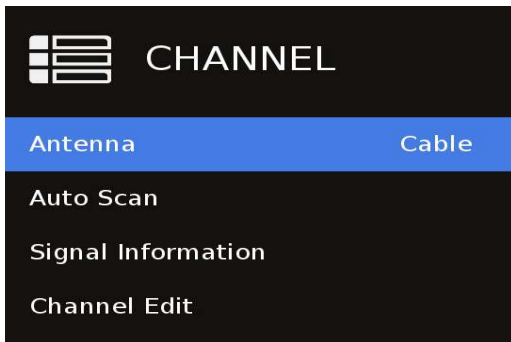

### Channel Menu.

This menu manages Channel functions including:

- Antenna, Select Air or Cable
- Auto Scan
- Signal Information
- Channel Edit

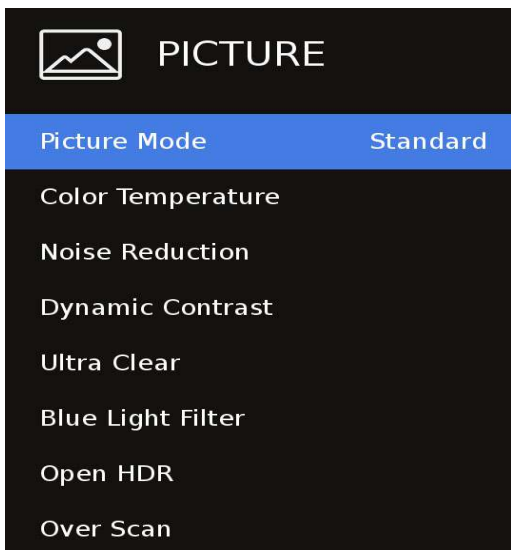

### Picture Menu.

This menu manages Picture functions including:

- Picture Mode
- Color Temperature
- Aspect Ratio
- Noise Reduction
- Dynamic Contrast
- Ultra Clear
- Blue Light Filter
- Open HDR (available on HDMI only)
- Overscan

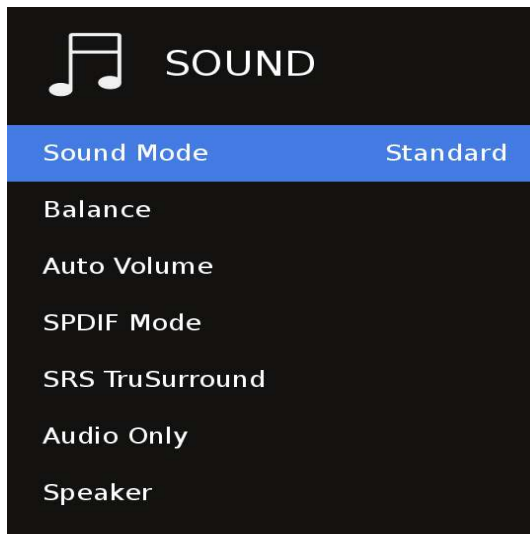

### Sound Menu.

This menu manages sound functions including:

- Sound Mode
- Balance
- Auto Volume
- SPDIF Mode
- SRS TruSurround
- Audio Only
- Speaker

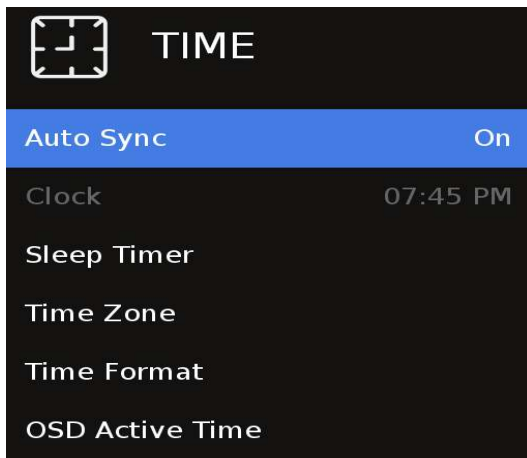

### Time Menu

This menu manages Time functions including:

- Auto Sync
- Clock (selectable if Auto Sync is off)
- Sleep Timer
- Time Zone
- Time Format
- OSD Active Time

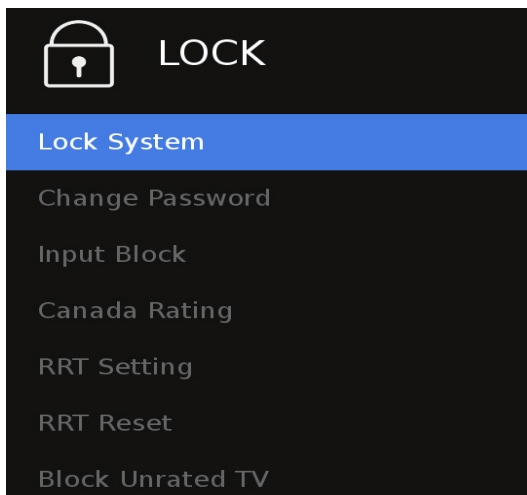

### Lock Menu

This menu manages Lock functions including:

- Lock System
- Change password (default password is 0000)
- Input Block
- Canada Rating
- RRT Setting
- RRT Reset
- Block Rated TV

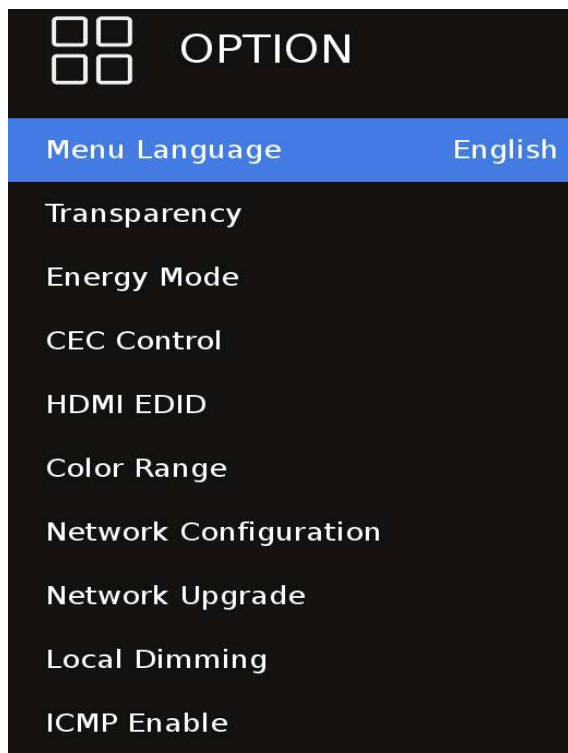

### Option Menu (page 1 of 2)

This menu manages Setup functions including:

- Menu Language
- Transparency (menu)
- Energy Mode
- CEC Control
- HDMI EDID
- Color Range
- Network Configuration
- Network Upgrade
- Local Dimming
- IMCP Enable

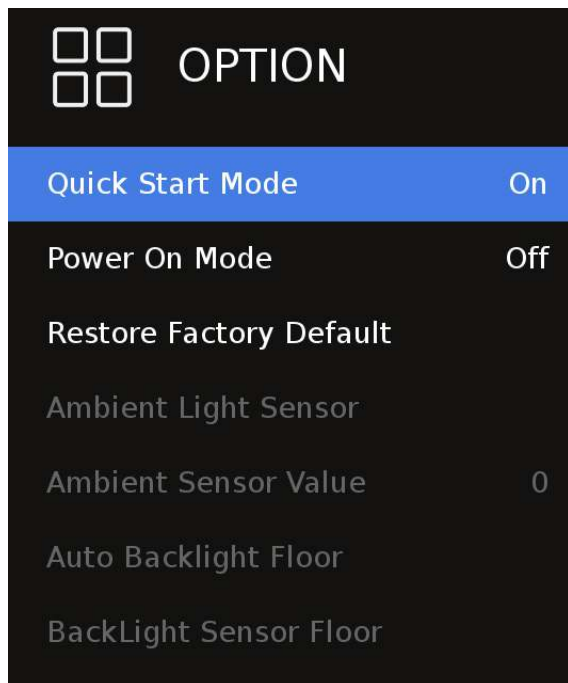

### Option Menu (page2 of 2)

This menu manages Setup functions including:

- Quick Start Mode
- Power on mode
- Restore Factory Default
- Ambient Light Sensor
- Ambient Sensor Value
- Auto Backlight Floor
- Backlight Sensor Floor

## Adjusting On-Screen Displays – Channel Menu

1. Press the ▼▲ buttons on the remote or CH+/CH- on the TV) to move the cursor to the item to be selected.
2. Press the ◀▶ buttons on the remote or VOL+/VOL- on the TV to make the desired adjustments.
3. When your adjustments are complete, press MENU or EXIT on the remote or MENU on the TV to exit the main menu.

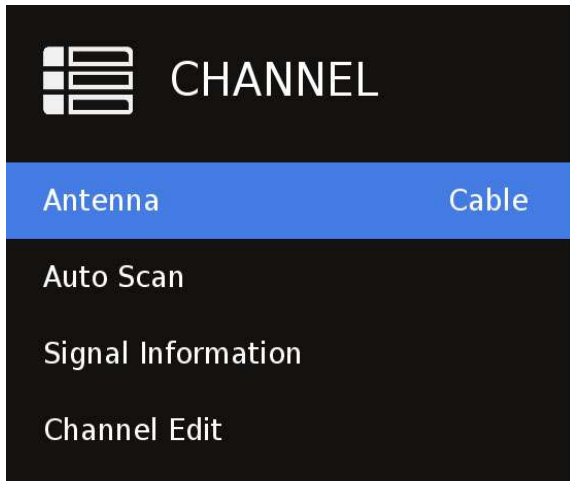

Figure (25-1) Channel Menu



Figure (25-2) Channel scan progress  
Press menu to interrupt the learning process,  
learned channels will be stored.

The Channel Menu (figure 25-1) is available only when TV is selected as the source. To select TV as the source, push the SOURCE button on the remote repeatedly until TV comes up as the source in the onscreen display. Or push the INPUT button on the side of the TV, then push the CH+ or CH- button on the side of the TV repeatedly until TV comes up as the source in the onscreen display.

### Air/Cable

Press the ▼▲ buttons to highlight the Air/Cable adjustment. Press the ◀▶ buttons to select Air (antenna) or Cable.

### Auto Scan (Figure 25-2)

Press the ▼▲ buttons to highlight the Air/Cable adjustment. Press the ▶ button to begin the Auto Scan process. A screen will appear with the message "Are You Sure You Want to Auto Scan?" Press the ◀ button to begin Auto Scan, or ▶ to go back to the Menu. Auto Scan will automatically build a list of the stations your TV can receive through the antenna or cable. The scan process will typically take 5 to 10 minutes.

### Signal Information

Displays current channel information:

Example:

*Antenna Cable*

*Channel 7*

*Modulation 256QAM*

*Signal Information Very Strong*

### Channel Edit

Press the ▼▲ buttons to highlight the Show/Hide adjustment. Press the ▶ button to begin the Auto Scan process. A screen will appear with the list of channels learned into the channel memory.

Highlight those channels which you do not wish to keep, have poor signal or are scrambled and hide them from the channel selections.





### Channel Edit

Press the ▼▲ buttons to highlight the desired channel and Press <enter>

The channel will be displayed

Using the Add▼ button on the remote you can change the text name of the learned channel.

Using the Delete▲ button on the remote you can skip the channel when using Ch +/-.

You will see a Ⓞ character appear next to the channel in the list.



## Adjusting On-Screen Displays – Picture Menu

1. Press ▼▲ buttons on the remote or CH+/CH- on the TV) to move the cursor to the item to be selected.
2. Press ◀▶ buttons on the remote or VOL+/VOL- on the TV to make the desired adjustments.
3. When your adjustments are complete, press MENU or EXIT on the remote or MENU on the TV to exit the main menu.

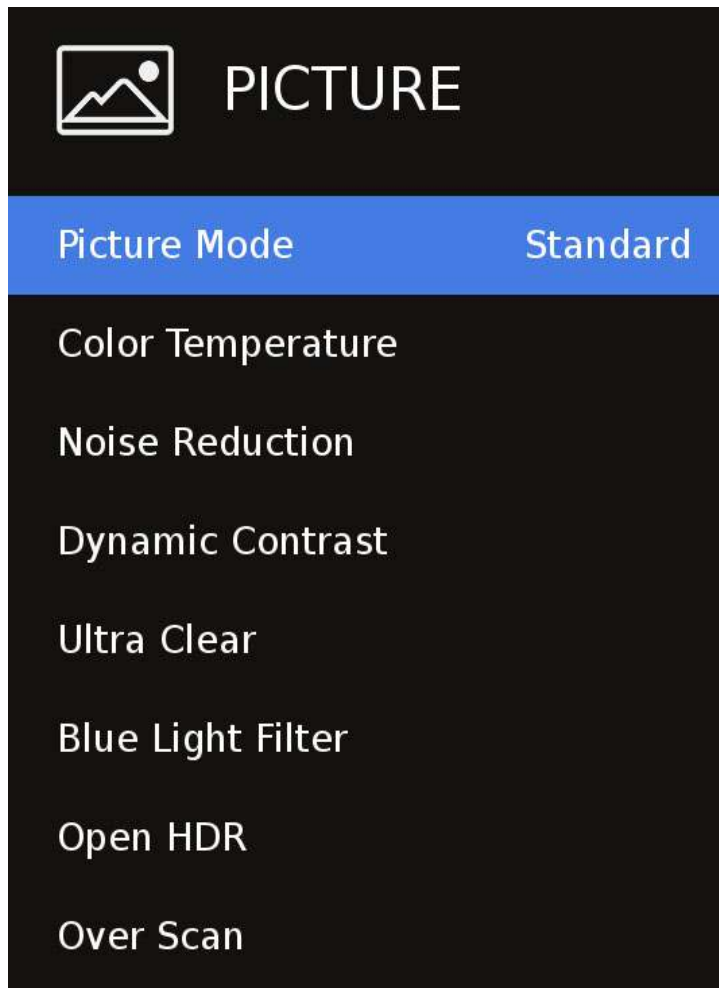

### Picture Mode

Press the ▼▲ buttons to highlight Picture Mode, press <enter>, then use ◀▶ to select presets

Standard

Dynamic

OptiView SunBrite Day

Optiview SunBrite Night

User

Auto(PC) - VGA only

PC - VGA only

OptiView Day and Night modes provide the ultimate outdoor viewing experience with a single touch. These preconfigured, end-user settings are optimized for brighter daytime or darker nighttime outdoor viewing environments.

*Select Personal Mode if you wish to enable and use the ambient light sensor for backlight dimming.*

### Color Temperature

Press the ▼▲ buttons to highlight Color Temperature adjustment, press <enter>, then use ▼▲ to select

Cool

Normal

Warm

### Aspect Ratio\*

Press the ▼▲ buttons to highlight aspect adjustment, press <enter> then use ◀▶ to select aspect 4:3 / 16:9.

### Noise Reduction

Press the ▼▲ buttons to highlight noise reduction, press <enter>, then use ◀▶ to select, off, weak, middle, strong or auto. This setting is used to determine the level of digital artifacts the TV will attempt to process resulting in a softer or sharper image.

### Dynamic Contrast

Press the ▼▲ buttons to highlight Dynamic Contrast, press <enter>, then use ◀▶ to select Off or On.

### Ultra Clear

Press the ▼▲ buttons to highlight Motion Enhancement, press <enter>, then use ◀▶ to select Off or On.

### Blue light Filter

Press the ▼▲ buttons to highlight Blue Light Filter, press <enter>, then use ◀▶ to select Off, or On.

### Open HDR \*

Press the ▼▲ buttons to highlight Open HDR, press <enter>, then use ▼▲ to select Off, Auto, Low, Middle or High.

### Overscan

Press the ▼▲ buttons to highlight Overscan, press <enter>, then use ▼▲ to select Off, On.

\* Menu function may not be available on all inputs.

## Adjusting On-Screen Displays – Sound Menu

1. Press ▼▲ buttons on the remote or CH+/CH- on the TV) to move the cursor to the item to be selected.
2. Press ◀▶ buttons on the remote or VOL+/VOL- on the TV to make the desired adjustments.
3. When your adjustments are complete, press MENU or EXIT on the remote or MENU on the TV to exit the main menu.

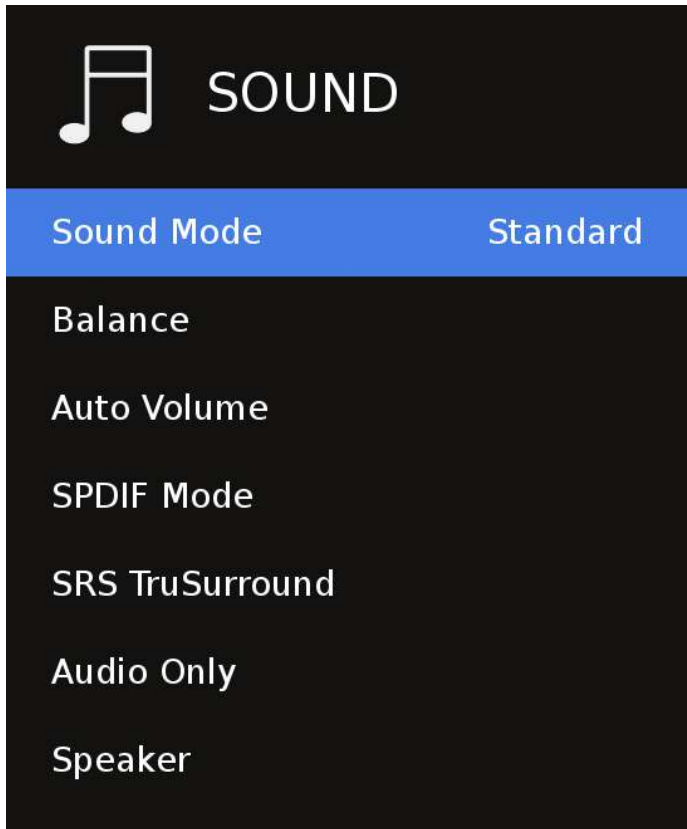

### Sound Mode

Press the ▼▲ buttons to highlight Sound Mode, then use ◀▶ to select presets Standard, Music, Movie, Sports or User sound mode.

### Balance

Press the ▼▲ buttons to highlight Balance, press <enter>, then use ◀▶ to select and set the left and right speaker balance. (-50/+50)

### Auto Volume

Press the ▼▲ buttons to highlight the Digital Output adjustment, press <enter>, then use ◀▶ to select PCM or Raw (bitstream). Use Raw only if the connected audio system can decode Dolby Digital. This function operates only when TV is selected as the source.

### SPDIF Mode

Press the ▼▲ buttons to highlight the Surround Sound adjustment, press <enter>, then use ◀▶ to switch the digital audio stream out from auto or PCM.

### SRS TruSurround

Press the ▼▲ buttons to highlight the SRS TruSurround adjustment, press <enter>, then use ◀▶ to switch the surround digital audio processing on or off.

### Audio Only

Press the ▼▲ buttons to highlight the Audio Only, press <enter>, then use ◀▶ to switch on and off. This function will turn off the video portion of the source content.

### Speaker

Press the ▼▲ buttons to highlight the Speaker, press <enter>, then use ◀▶ to switch on and off. This function will turn the speaker bar output on and off.

## Adjusting On-Screen Displays – Time Menu

1. Press ▼▲ buttons on the remote or CH+/CH- on the TV) to move the cursor to the item to be selected.
2. Press ◀▶ buttons on the remote or VOL+/VOL- on the TV to make the desired adjustments.
3. When your adjustments are complete, press MENU or EXIT on the remote or MENU on the TV to exit the main menu.

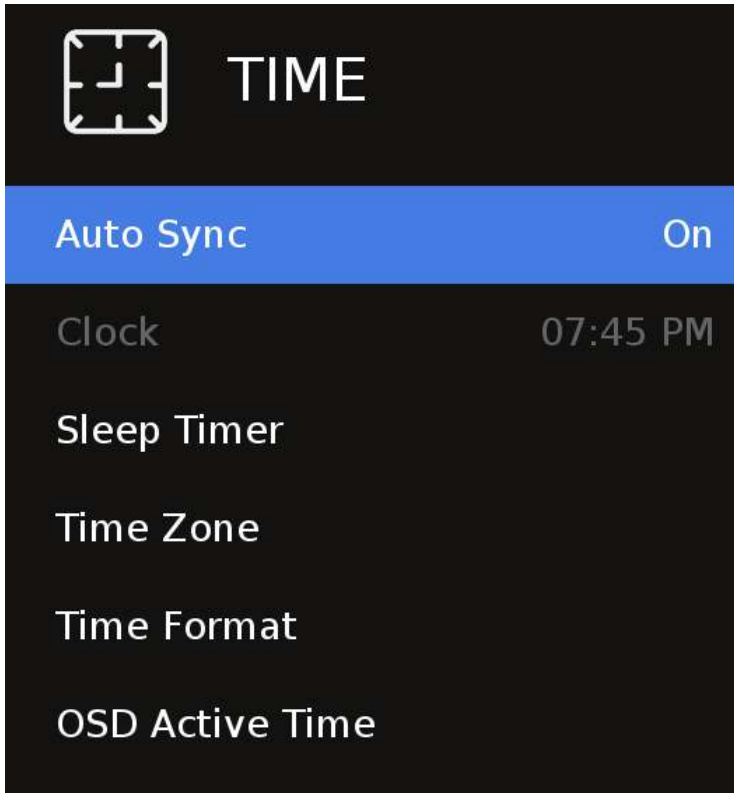

### Auto Sync

Press the ▼▲ buttons to highlight the Auto Sync adjustment, then use ◀▶ to turn auto sync on and off. Auto sync automatically sets the time on your TV based on information from TV signals or internet time when connected to a network. Clock setting adjustments are not available when auto sync is activated.

### Clock

Press the ▼▲ buttons to highlight the Clock setting adjustment, then use ◀▶ to enter the Clock submenu pictured at left.

Now press the ▼▲ buttons to highlight the adjustment you want to make (day, hour, minute, etc.), then use ◀▶ to make the adjustment. Repeat until the clock is set correctly.

Note the TV does not have a battery backed up clock. Should power be lost the setting will be reset to default.

### Sleep Timer

Press the ▼▲ buttons to highlight Sleep Timer, then use ▼▲ to select Off or 10, 20, 30, 60, 90, 120, 180 or 240 minutes. The TV will turn off automatically after the selected time has elapsed.

### Time Zone

Press the ▼▲ buttons to highlight the Time Zone adjustment, then use ▼▲ to select Newfoundland, Atlantic, Eastern, Central, Mountain, Pacific, Alaska or Hawaii time zone.

### Time Format

Press the ▼▲ buttons to highlight the Time Format adjustment, then use ▼▲ to select 12-hour or 24-hour (military) time format.

### OSD Active Time

Press the ▼▲ buttons to highlight the OSD Active time adjustment, then use ◀▶ to select the amount of time the OSD menus will display before timing out, 5s, 10s, 15s, 20s or always On.

## Adjusting On-Screen Displays – Lock Menu

1. Press ▼▲ buttons on the remote or CH+/CH- on the TV) to move the cursor to the item to be selected.
2. Press ◀▶ buttons on the remote or VOL+/VOL- on the TV to make the desired adjustments.
3. When your adjustments are complete, press MENU or EXIT on the remote or MENU on the TV to exit the main menu.

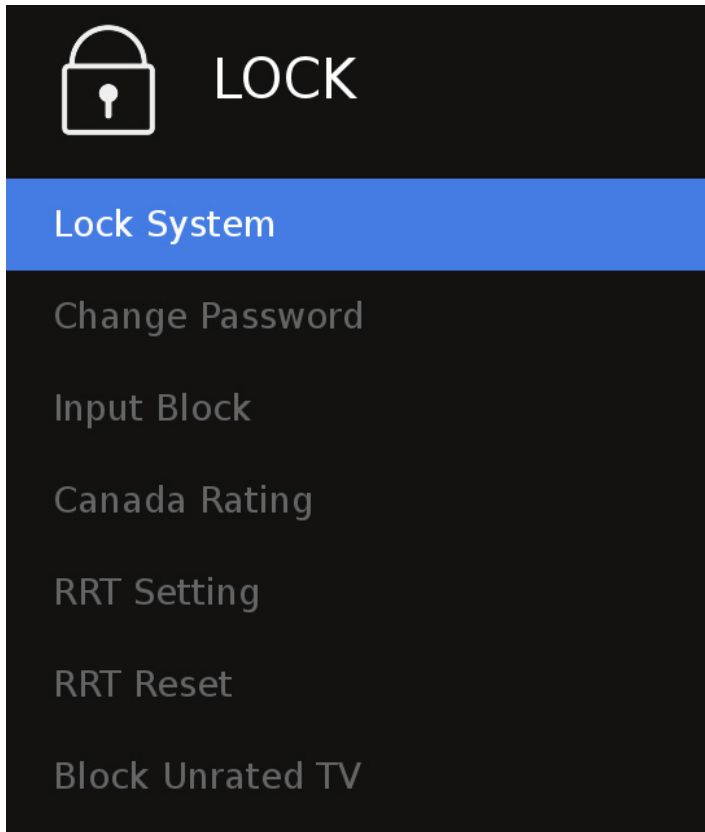

### System Lock

Press the ▼▲ buttons to highlight System Lock, then use ◀▶ to enter the Password menu shown at lower left. This menu allows you to set a password that will be required to access inputs that are locked out using the Input Block feature described below.

### Change Password

Press the ▼▲ buttons to highlight Change Password, then use ◀▶ to enter the Change Password menu shown at left. To change the password, use the numeric keypad on the remote to enter the current password (0000 unless you previously changed it), then enter the new password twice.

If you enter a new password but forget it later, contact your SunBrite TV dealer for assistance.

### Input Block

Press the ▼▲ buttons to highlight Input Block, then use ▼▲ to highlight the input to be blocked. TV, Component1, PCRGB(VGA), HDBaseT, HDMI1, HDMI2, AV

### US Rating (not pictured) \*

Press the ▼▲ buttons to highlight US Rating, then use ▼▲ to highlight the rating to be used, TV or MPAA.

### Canada Rating \*

Press the ▼▲ buttons to highlight Canada Rating, then use ▼▲ to highlight the rating to be used, Canada English or Canada French.

### RRT Setting\*

Factory use only.

### RRT Reset\*

Factory use only.

### Block Unrated TV\*

Press the ▼▲ buttons to highlight Block Unrated TV, then use ▼▲ to highlight the setting On or Off.

\* Menu function may not be available on all inputs.

## Adjusting On-Screen Displays – Option Menu

1. Press ▼▲ buttons on the remote or CH+/CH- on the TV) to move the cursor to the item to be selected.
2. Press ◀▶ buttons on the remote or VOL+/VOL- on the TV to make the desired adjustments.
3. When your adjustments are complete, press MENU or EXIT on the remote or MENU on the TV to exit the main menu.

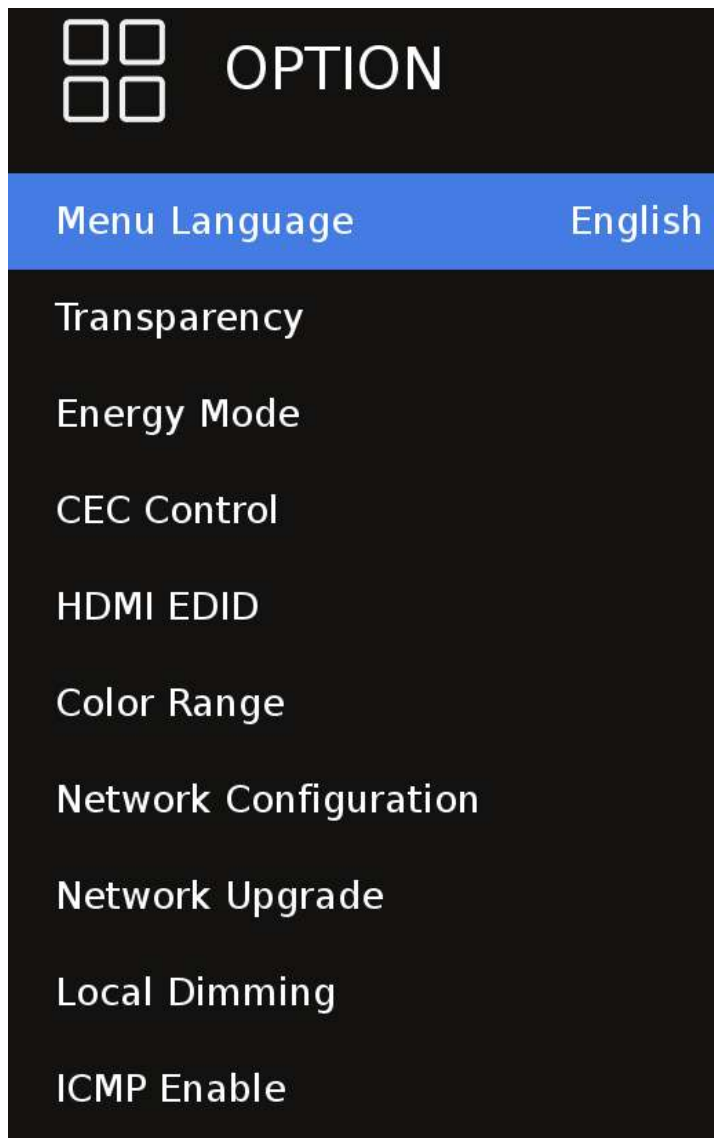

### Menu Language

Press the ▼▲ buttons to highlight Menu Language, then use ◀▶ to select English, French or Spanish.

### Transparency

Press the ▼▲ buttons to highlight Transparent, then use ▼▲ to select to what degree the picture shows through the on-screen menus: 0%, 25%, 50%, 75% or 100%.

### Energy Mode

Press the ▼▲ buttons to highlight Transparent, then use <enter> to select On or Off. On will dim the backlight to a preset level allowing the display to consume less power.

### CEC Control

Press the ▼▲ buttons to highlight CEC control, then use ◀▶ to select On or Off. On will turn on the features in CEC control - including ARC (Audio Return Channel).

#### CEC Control options (not pictured)

**Auto Standby On / Off** - when On the TV will use CEC control to put the source device in standby / off.

**TV Auto Power On** - when On the source device will use CEC control to turn the TV on.

**TV Auto Power Off** - when On the source device will use CEC control to turn the TV off.

**Audio Receiver (ARC)**- when On the TV will use ARC to return audio using HDMI1 back to an audio receiver..

**Device List** - used for CEC trouble shooting. CEC enabled devices should be display when selected.

**Connect** - used for CEC trouble shooting. Scans the HDMI ports for CEC enabled devices.

**Root Menu** - used for CEC trouble shooting. Attempts to send a root menu command to the HDMI ports for CEC enabled devices.

**Note: CEC must be turn on to enable ARC.**

### HDMI EDID

Press the ▼▲ buttons to highlight the EDID Switch, then use ▼▲ to select EDID 1.4 or EDID 2.0 mode.

EDID 1.4 should be used for older devices or with 4k extenders or cables which are limited to 4k @ 30hz.

EDID 2.0 should be used for newer source devices for full 4k @ 60hz resolution



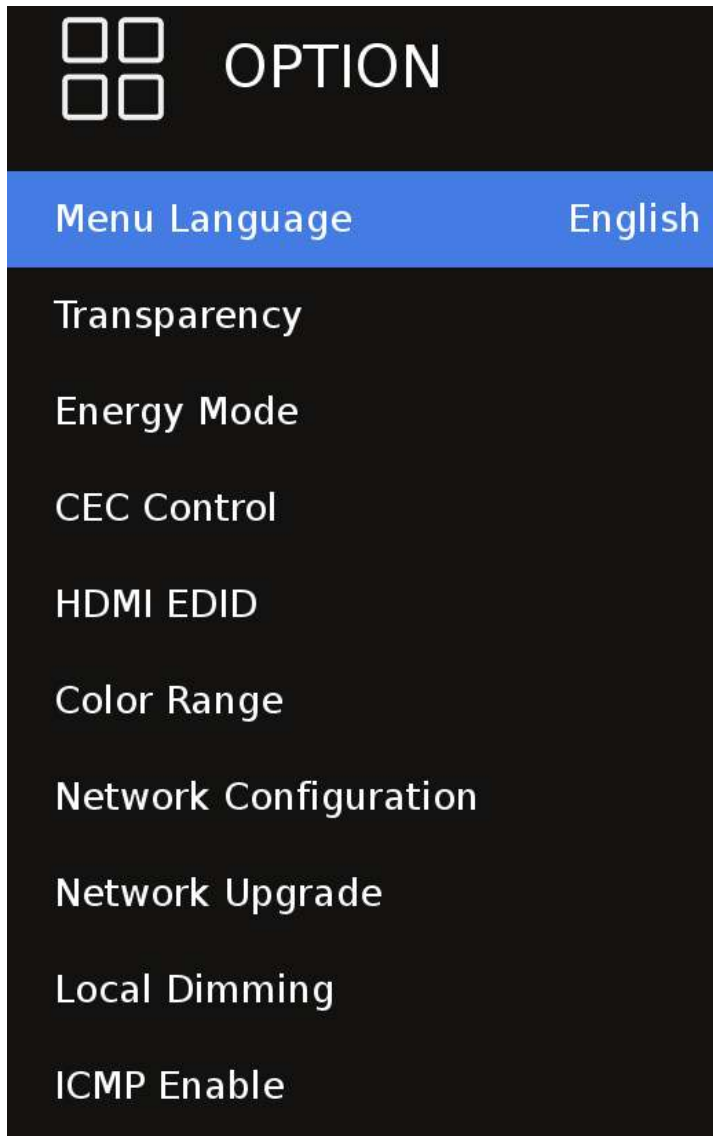

**Color Range**

Press the ▼▲ buttons to highlight Color Range, then use <enter> to select Auto, 16-235, or 0-255.

Auto, the TV will select color range based on the input and source content.

0-255, typically used for PC content

16-235, typically used for TV content

**Network Configuration**

Press the ▼▲ buttons to highlight the Network Configuration, then use <enter> to select, then <enter> or wired network. Use ◀▶ DHCP (Auto assigned) or Static network IPv4 address.

**Network Configuration**

reserved for future use

**Local Dimming**

Press the ▼▲ buttons to highlight the local Dimmig, then use <enter> to select On or Off.

Local dimming is supported on 65 and 75 inch sizes only. This setting has no effect on 43 and 55 inch screen sizes.

**ICMP Enable (Network Ping Enable)**

Press the ▼▲ buttons to highlight the ICMP Enable, then use <enter> to select On or Off.

This feature is off by default and used for network troubleshooting.

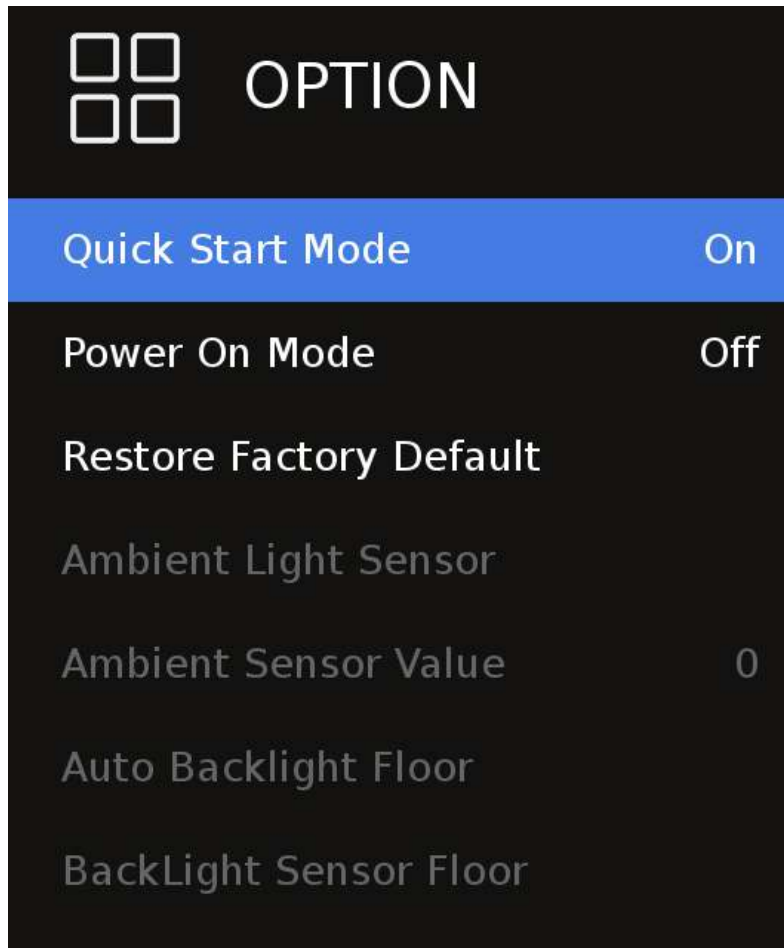

### Quick Start Mode

Press the ▼▲ buttons to highlight the Quick Start Mode, then use ◀▶ to turn select on and off.

Quick start mode, On by default, allows the TV to turn on quickly and start displaying content.

Quick start mode, must be On to have full IP control to turn on the TV when in Standby.

Quick start mode, Off, will consume less power when in Standby, and IP control will not function to turn the TV on.

### Power On Mode

Press the ▼▲ buttons to highlight the Power On Mode, then use ◀▶ to select on, off or memory.

Power on Mode, Off by default, sets the TV to return to a standby state after AC power is lost and restored.

Power on Mode, On, sets the TV to return to a On state after AC power is lost and restored.

Power on Mode, Memory, after AC power loss and restore, sets the TV to return to the running state when AC power was lost.

### Restore Factory Default

Press the ▼▲ buttons to highlight the Restore Factory Default, then use <enter> to select on. Use ◀▶ to select Yes or No, then press <enter>.

This will restore all the user settings to their defaults.

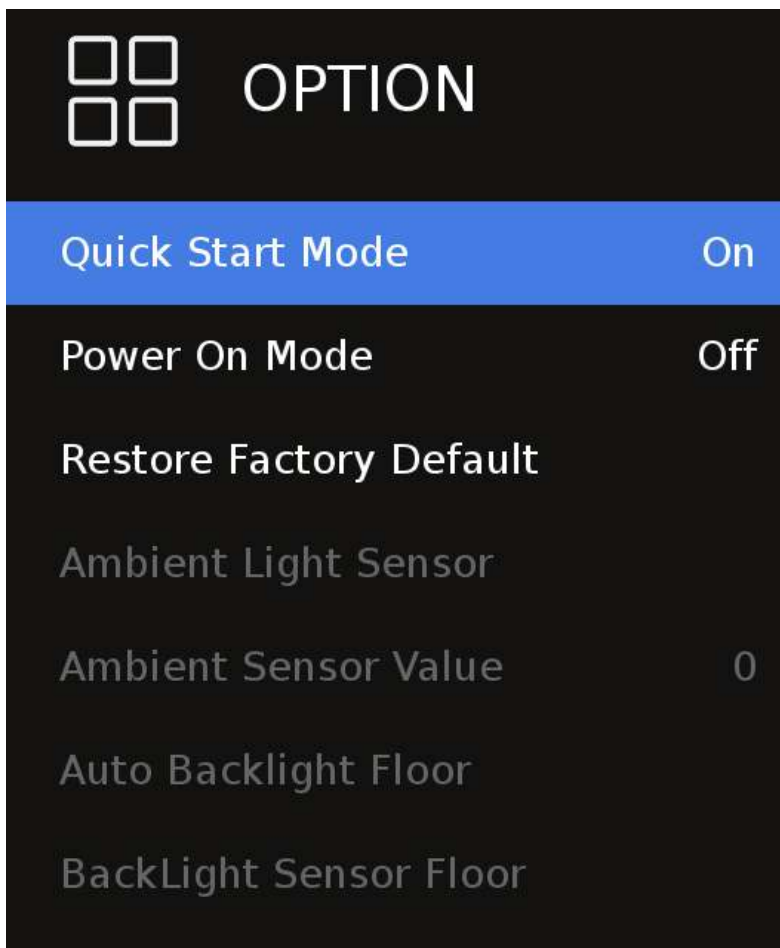

### Ambient Light Sensor

*Note the Ambient sensor function is only available when the User Picture mode is selected.*

Press the ▼▲ buttons to highlight the Ambient Light Sensor adjustment, then use ◀▶ to turn the ambient light sensor on and off. The ambient light sensor automatically measures ambient light level and adjusts the backlight to the level preset using the Auto Backlight Floor adjustment explained below. When TV is selected as a source, you will have to go all the way to the bottom of the Setup menu and press ▼ to reach this adjustment.

### Ambient Sensor Value

This meter shows the level of ambient light as measured at the light sensor on front of the TV (near the SunBright TV logo). This shows the level of the ambient light. The value in the meter remains fixed until another menu item is highlighted. To refresh the meter, press the ▼▲ buttons. Unless TV is selected as the source, you will have to go all the way to the bottom of the Setup menu and press ▼ to reach this adjustment. This adjustment is available only when the ambient light sensor is activated.

### Auto Backlight Floor

This adjustment sets the level to which the backlight will be lowered when the ambient light level falls below the level set on the Backlight Sensor Floor adjustment below. Press the ▼▲ buttons to highlight the Auto Backlight Floor adjustment, then use ◀▶ to set the auto backlight floor value. This adjustment is available only when the ambient light sensor is activated.

### Backlight Sensor Floor

This adjustment sets the threshold for the automatic backlight adjustment, governed by the ambient light sensor.

When the Ambient Light Sensor value is above the Backlight Sensor Floor value, the backlight level will be 100%.

When the Ambient sensor value is below BackLightSensor Floor value the backlight is reduced to the level set with the Auto Backlight Floor adjustment.

Press the ▼▲ buttons to highlight the Backlight Sensor Value adjustment, then use ◀▶ to set the backlight sensor value. This adjustment is available only when the ambient light sensor is activated.

### How it works:

If the Ambient sensor value is below the value set in Backlight sensor floor, the backlight will DIM (Night Mode)

If the ambient sensor value is above the value set in the backlight sensor floor, the backlight will return to 100% brightness (Day Mode)

## Menu - Media Photos

Using the USB input on the rear panel of the TV, you can access material stored on a USB stick. The material can be MP3 or WAV music files, or JPEG or BMP pictures. The TV is not configured to play user Videos from a USB flash Drive.

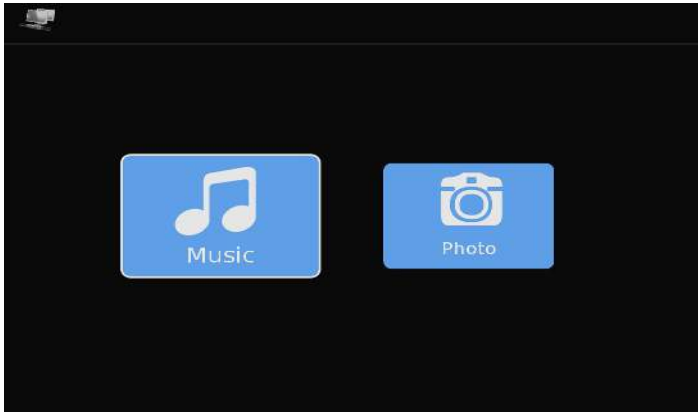

### Accessing the USB input

Press the Menu button on the remote or on the side control panel of the TV, then press ▼▲ buttons to highlight Media and press <enter>.

Select Music or Photo and press <enter>

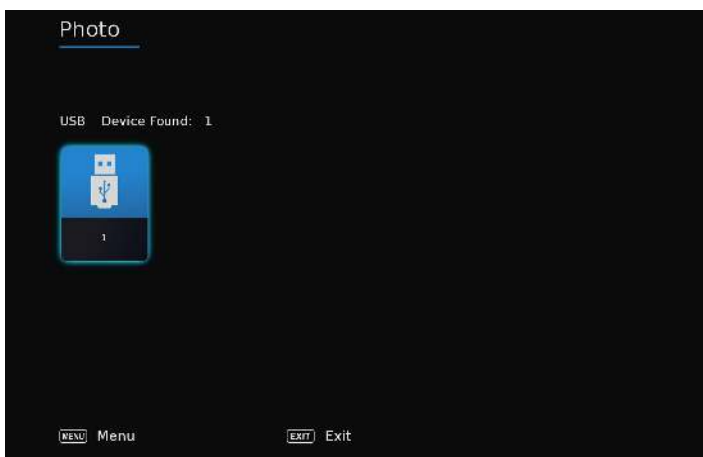

If a USB flash drive can be accessed by the TV it will display as shown, press <enter> to select it. If there is an issue accessing the USB flash drive it will be displayed in grey.



### Viewing Pictures from the USB Flash

Use ◀▶ to highlight the picture you want to view, then press ↵ to view that picture. Highlight a thumbnail and press ↵ to select photo.

After a photo is selected a slide show will begin showing all photos in the folder.

During playback a menu will appear at the bottom of the screen

Use ◀▶ to highlight the function, then press ↵

These functions allow repeat play, pause, rotate and zoom.

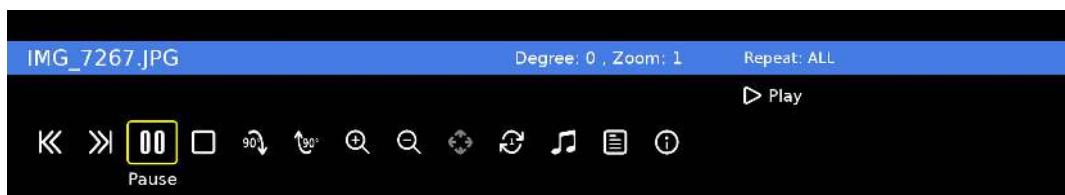

## Menu - Media MP3 Audio

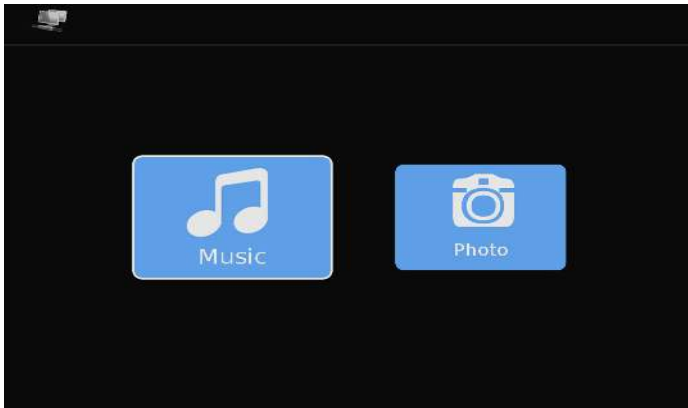

### Accessing the USB input

Press the Menu button on the remote or on the side control panel of the TV, then press ▼▲ buttons to highlight Media and press <enter>.

Select Music or Photo and press <enter>

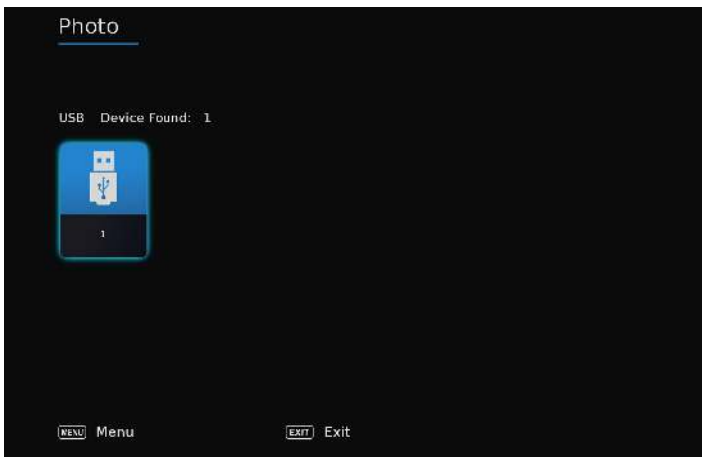

If a USB flash drive can be accessed by the TV it will display as shown, press <enter> to select it.

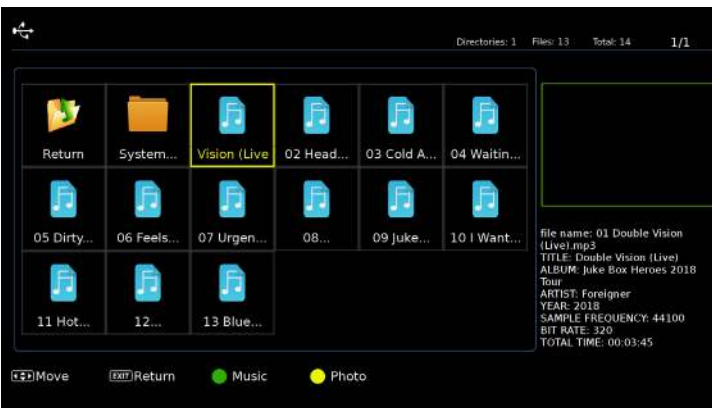

### Listening MP3 Audio from the USB Stick

Use ◀▶ to highlight the MP3 file, then press ↵ to view that picture. Highlight a thumbnail and press ↵ to select photo.

After a photo is selected a slide show will begin showing all photos in the folder.

During playback a menu will appear at the bottom of the screen

### Listening to Music from the USB Stick

Use ◀▶ to highlight the tune you want to listen to, then press ↵ to play the tune.. The music will begin playing, and a text screen that shows data about the audio file will appear.

During playback a menu will appear at the bottom of the screen

Use ◀▶ to highlight the function, then press ↵

These functions allow repeat play, pause, rotate and zoom.

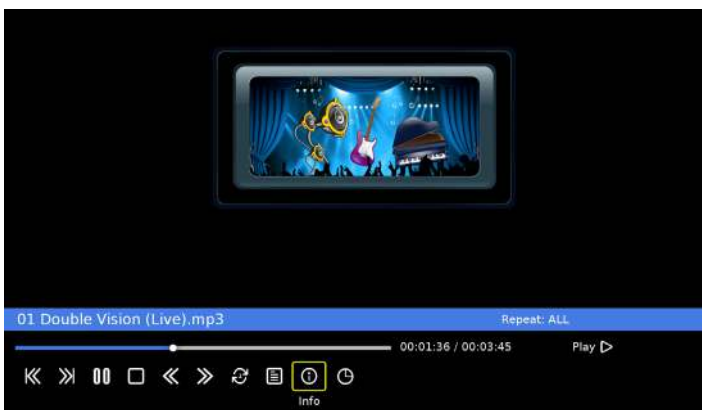

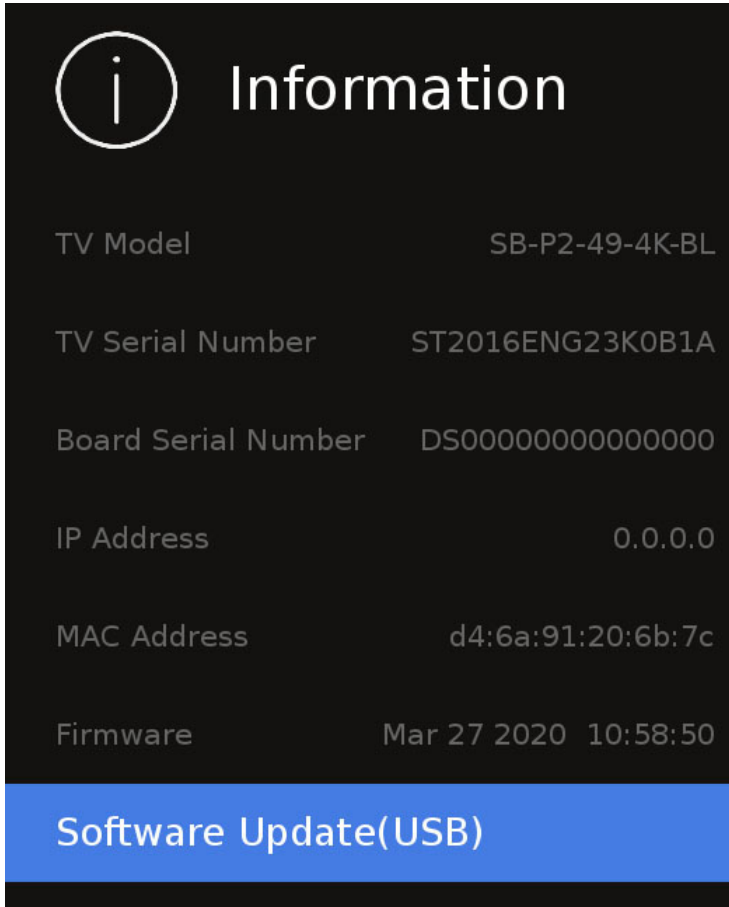
**TV Model**

The Sunbrite TV model number

**TV Serial Number**

Also referred to as the service tag, this is the product serial number which matches the serial number tag found inside the media bay.

**Board Serial Number**

Unique ID number of the TV main board.

**IP Address**

When properly connected to an ethernet wired network, the IP V4 network address will display.

**IP Address**

Unique hardware address of the TV ethernet network port.

**Firmware**

Current build date and time of the TV firmware.

Above items cannot be changed on this menu and are for service and reference only.

**Software Update(USB)**

Use this feature as instructed by technical support to update the TV firmware using a USB flash drive.



## Troubleshooting

The following table contains the common problems and the solutions to these problems. Please check this list before you contact the technicians.

Trouble	Solutions
No picture	Check the following: Power cord is connected correctly. Power is turned on. The video cable is connected correctly. You have selected the proper input signal source. If you have done the above, without resolve, unplug TV for at least 1 hour to perform Hard Reset.
Abnormal colors	Match the colors on the cable to the connector. (Red cable to red colored port.)
Picture is too dark	Adjust your contrast, brightness and backlight settings from the OSD menu
Audio only, no picture	Make sure both the audio and video cables are connected. The TV tuner signal must not be lower than 65 percent. Unplug TV for at least 1 hour to perform Hard Reset.
Picture only, no audio	Make sure the audio cable is connected. Readjust your volume via the remote control. The TV tuner signal must not be lower than 65 percent.
Remote control does not work	Turn off the TV, unplug it from the socket. Remove the batteries from the remote for 30 minutes. Press the remote buttons and the power button randomly for 2 full seconds, then reinstall the batteries.  The TV's remote sensor is housed in the same place as the power indicator light. Make sure there is line of sight from the remote control's first sensor to the remote sensor of the TV.
Cannot receive sufficient channels through the ATSC/NTSC Tuner	The TV's tuner signal must not be lower than 65 percent. Change the direction of your antenna and re-scan the channels. If you have cable, call the cable provider and ask to have your signal strength checked.
No color	Adjust your picture setup and make sure the color saturation is not turned all the way down.
Weak signal or no program symbol on screen	The TV tuner signal must not be lower than 65 percent. Change the direction of your antenna and re-scan the channels. If you have cable, call the cable provider and ask to have your signal strength checked.
TV's Universal Remote Code	This television follows Sony's universal remote code. You may be able to find SunBriteTV's code in your own universal remote's guide book.
TV channels are blocked	Check the Auto Lock function settings on the OSD. Channels may have been locked previously.
The TV turns on or off slowly, and the screen shows up slowly	This is a high definition liquid crystal display panel TV. It requires a few more seconds than normal TVs to power up and show the picture.
No sound from PC	Make sure you have a 3.5 mm mini-jack cable connected from your PC's sound output to the TV's VGA Stereo Input.
HDCP video says no HDCP support	Reboot your HDCP video device by turning it off, and unplugging the power cord. Wait up to 8 minutes to plug the power back in to see if that works.
HDCP video has no audio	Make sure you have a 3.5 mm mini-jack cable connected from your HDCP video device sound output to the TV's VGA stereo input. If your HDCP video device uses RCA audio jacks, you'll need to obtain an audio cable with RCA plugs on one end and a 3.5mm plug on the other.
Cannot get 1920 x 1080 from PC VGA	Using VGA/PC the screen's max resolution is 1920 x 1080. Your video card may not support this resolution. Check your video card's maximum resolution, and use that setting.
Picture is distorted or has an abnormal sound	This might be from interference from large electrical appliances, cars, motorcycles or fluorescent lights. If the TV is close to the wall, try moving the TV to another location to see if the problem still occurs.
Picture does not cover the entire screen	If you are using HDMI or a TV digital channel, use the Aspect button to switch to 16:9 format. If you are using VGA, use the computer's video controls to adjust the image to the screen. Note: If you are watching regular 4:3 TV or 4:3 signals from a VCR or DVD player in 480i resolution, use the Aspect button to switch to 16:9 in order to fill up the screen. However, this feature will distort the picture.

Trouble	Solutions
Picture quality is very poor	For best image quality, view HD widescreen programs. If HD content is not available, use a digital source (DVD or Blu-ray player, digital satellite or digital cable box). Standard 480i TV programs will be noticeably inferior to HD quality.
Some pixels are always displaying the same color	SunBriteTV LCD screens are manufactured to rigorous standards to maintain optimal viewing. However, the LCD screen may have minor defects that appear as a small bright or dark pixel. This is common to all LCD screens used in display and television products, and is not specific to SunBriteTV. For more information, see SunBriteTV's Pixel Quality Policy in this manual.
Switching a channel or source changes the volume	Different channels and inputs sometimes have this effect because the channel signal's volume is pre-set.
There is noise or trash pixels on the screen	When your TV's resolution is higher than the digital channel's broadcast resolution, the signal is up-converted to match your TV's resolution. Up-converting can cause this kind of effect.
Tips for high-definition users	The TV is an ideal platform for viewing high-definition content. The best image quality can be achieved by HDMI, YPbPr (component), then VGA. However, due to variances in broadcast practices, it is possible that some image distortion may occur.
Tips for letterbox content users	Letterbox (widescreen) versions of DVD movies are most commonly formatted for standard 4:3 TVs. The TV has the capability of expanding this content so the entire screen is filled, at the expense of the image proportion. To use this function, press the Aspect button on the remote control and cycle among the available options.
The TV turns off automatically	The TV features a power-saving mode which will automatically turn off the TV if there is no signal provided for 15 minutes.

## Caring for the front Window:

### 1. Cleaning the front Panel:

With your TV turned off, gently wipe the surface of the display panel with a damp (with water) microfiber, cotton or flannel cloth. (Do not use tissues, rags, sponges or paper towels because they may damage the screen and leave lint pieces behind).

If the LCD panel is very dirty, you can mix equal parts of isopropyl alcohol and distilled water in a clean spray bottle, spray the mixture onto the cloth (do not spray the solution directly on the panel) and gently clean the panel.

### 2. When the TV is not in use, keep it covered with the SunBriteTV Outdoor Dust Cover:

The fitted dust cover is designed to protect the LCD panel from the harmful UV rays from direct sunlight, and keeps wind-blown objects from scratching the surface of the panel.

**To order a Dust Cover** contact your Authorized SunBriteTV dealer, SunBriteTV's Customer Care Center at 866-357-8688, or visit [www.sunbriteTV.com](http://www.sunbriteTV.com).

## General Cleaning

Remove any dirt and salt deposits from the unit, being careful to rinse the cloth frequently to avoid scratching the TV or screen surface. Avoid using harsh chemicals, abrasives, or solvents when cleaning any surface on the unit.

### Snow and Ice

Use a soft brush and towel to remove snow and ice from the unit.

### Fiber Filter

**Over time, the fiber filter collects dirt and must be cleaned or replaced periodically.**

The Fiber Filter is located on the back of the unit, inside the Intake and exhaust vent at the top and bottom of the TV (Figure 1).

1. Disconnect AC power to the TV display before servicing the filters.
2. Release the fiber filter cage by removing the two 6-32 fastening screws(Figure 2) and removing the filter cage by pulling on the tab as shown.(Figure 3) The filter cage is a tight fit, you may need to gently pull on the vent openings to work the filter cage from the rear bezel.
3. Pull the Fiber filter out of the TV, and wash it with mild detergent and warm water. After rinsing, let the Fiber Filter dry completely. If necessary replace the filter material.(Figure 4)
4. Put the Fiber Filter cage back into the rear bezel and secure with two 6-32 screws.

Figure 1



Intake Vent

Figure 2



Figure 3

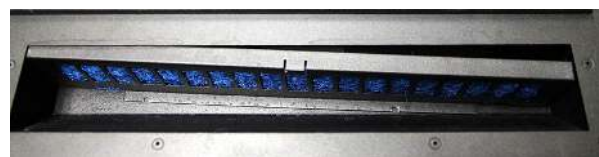

Figure 4



**CAUTION! NEVER SPRAY OR DIRECT A HOSE INTO THE VENT AREA OF THE TV.**

**To Order Replacement Filters**, contact SunBriteTV's Customer Care Center at 866-357-8688

# Specifications

LCD Screen	32-inch diagonal Color Active Matrix TFT LED LCD
Resolution	1920 x 1080 FHD (4k input scaled to 1080p)
Aspect Ratio	16:9
Backlight Brightness - Surface Luminance, white	1500 nits (cd/m2)
Contrast Ratio	3000:1
Front Window	AG Laminate glass
Response Time	8 milliseconds
TV formats	2160p*, 1080p, 1080i, 720p, 720i, 480p, 480i * using hdmi only (2160p input scaled to 1080p)
Input Connectors:	
Tuner	Antenna/CATV (ATSC/QAM/NTSC) x1
HDMI	HDMI Input x 2 (supports HDMI 2.0, HDCP 2.2, HDMI 1.4 & HDCP 1.4a)
Video Composite	Composite Video, L/R Audio Inputs x1
Video Component	YPbPr plus Stereo Audio x1 (using 3.5mm to RCA adapter - not included)
PC	15-pin D-sub VGA plus Stereo Audio
Ethernet	RJ45 - Single Cat5e/Cat 6 cable
HDBase-T	RJ45 - Single Cat5e/Cat 6 cable*
	*refer to detailed data sheet for supported resolutions, refresh, color depth and Cat5e/Cat 6 cable lengths.
Control Set	RS232 Serial, Discrete IR Control, Concealed rear IR Window, IP Control, OvrC
Audio Out	Digital Optical TosLink x 1 (fixed) Analog 1/8" headphone jack (variable)
Accessory DC Power Out	5vdc @ 3.5amps 1.3mm power jack or usb type A jack
Speaker Output	20-watt(10w x 2) Does not have internal speakers. Optional Speaker Bar not included.
Exterior	Powder-coated aluminum
Colors	Silver, Black and White
Input Power	100-240 VAC, 50-60 Hz 2.5A max
Operating Temp.	-24° to 122° F. (-31° to 50° C.) *
Non-op. Temp. (Off-mode with power applied)	-24° to 140° F. (-31° to 60° C.) The non-operating temperature feature requires power to be applied
Accessories Included	Water-resistant remote control
Dimensions	30.5in W x 18.32in H x 4.49in D 771mm W x 466mm H x 114mm D
Weight	TV 41 lbs / 19 kgs Shipping 49 lbs / 22 kgs
Residential Warranty	Two year, in-factory, parts and labor
Commercial Warranty	Two year, in-factory, parts and labor
Mount Pattern	100mm x 100mm / 200mm x 200mm

## Model SB-P2-32-1K Pro 2 Series Full HD Dimensions

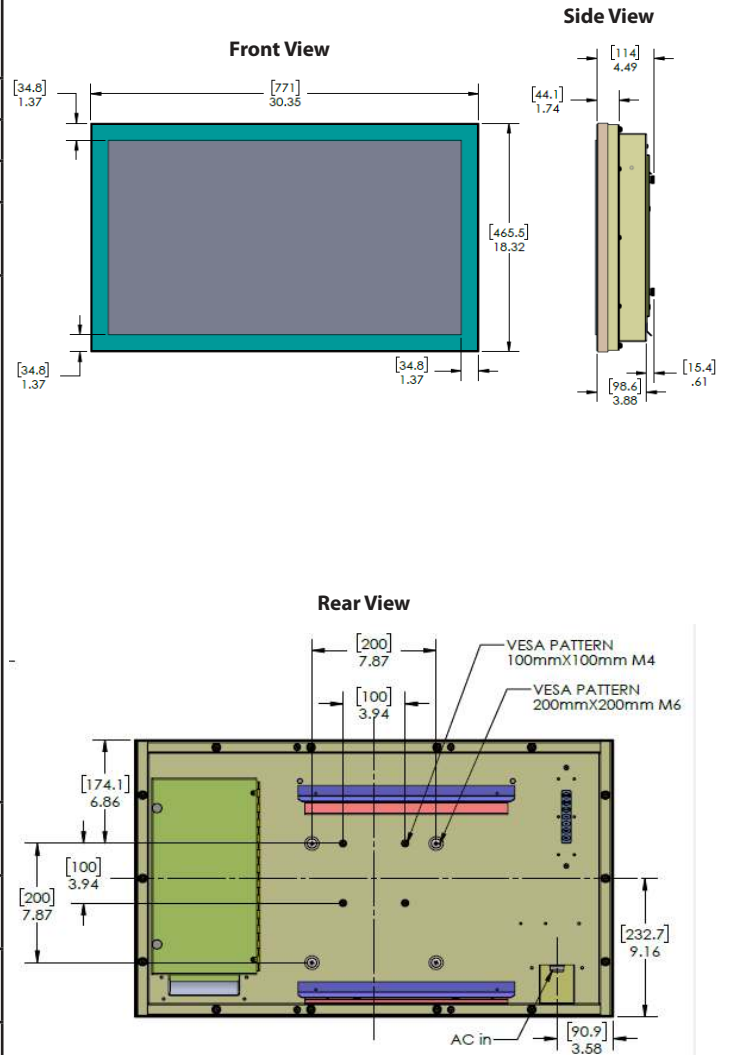

TV intended to be fastened in place using, 4ea, M4 x 12mm screws and washers (100mm x 100mm pattern) or 4ea, M8 x 30mm screws and washers and a UL listed wall mount.

Specifications are subject to change. 05/04/2020

# Specifications

LCD Screen	43-inch diagonal Color Active Matrix TFT LED LCD
Resolution	1920 x 1080 FHD (4k input scaled to 1080p)
Aspect Ratio	16:9
Blacklight Brightness - Surface Luminance, white	1500 nits (cd/m2)
Contrast Ratio	3000:1
Front Window	AG Laminate glass
Response Time	8 milliseconds
TV formats	2160p*, 1080p, 1080i, 720p, 720i, 480p, 480i * using hdmi only (2160p input scaled to 1080p)
Input Connectors:	
Tuner	Antenna/CATV (ATSC/QAM/NTSC) x1
HDMI	HDMI Input x 2 (supports HDMI 2.0, HDCP 2.2, HDMI 1.4 & HDCP 1.4a)
Video Composite	Composite Video, L/R Audio Inputs x1
Video Component	YPbPr plus Stereo Audio x1 (using 3.5mm to RCA adapter - not included)
PC	15-pin D-sub VGA plus Stereo Audio
Ethernet	RJ45 - Single Cat5e/Cat 6 cable
HDBase-T	RJ45 - Single Cat5e/Cat 6 cable*
	*refer to detailed data sheet for supported resolutions, refresh, color depth and Cat5e/Cat 6 cable lengths.
Control Set	RS232 Serial, Discrete IR Control, Concealed rear IR Window, IP Control, OvrC
Audio Out	Digital Optical TosLink x 1 (fixed) Analog 1/8" headphone jack (variable)
Accessory DC Power Out	5vdc @ 3.5amps 1.3mm power jack or usb type A jack
Speaker Output	20-watt(10w x 2) Does not have internal speakers. Optional Speaker Bar not included.
Exterior	Powder-coated aluminum
Colors	Silver, Black and White
Input Power	100-240 VAC, 50-60 Hz 2.5a max
Operating Temp.	-24° to 122° F. (-31° to 50° C.) *
Non-op. Temp. (Off-mode with power applied)	-24° to 140° F. (-31° to 60° C.) The non-operating temperature feature requires power to be applied
Accessories Included	Water-resistant remote control
Dimensions	39in W x 23in H x 3.60in D 988mm W x 582mm H x 91mm D
Weight	TV 69 lbs / 31 lg Shipping 51 lbs (23.1 kgs)
Residential Warranty	Two year, in-factory, parts and labor
Commercial Warranty	Two year, in-factory, parts and labor
Mount Pattern	200mm x 200mm

## Model SB-P2-43-1K Pro 2 Series 4K Full HD Dimensions

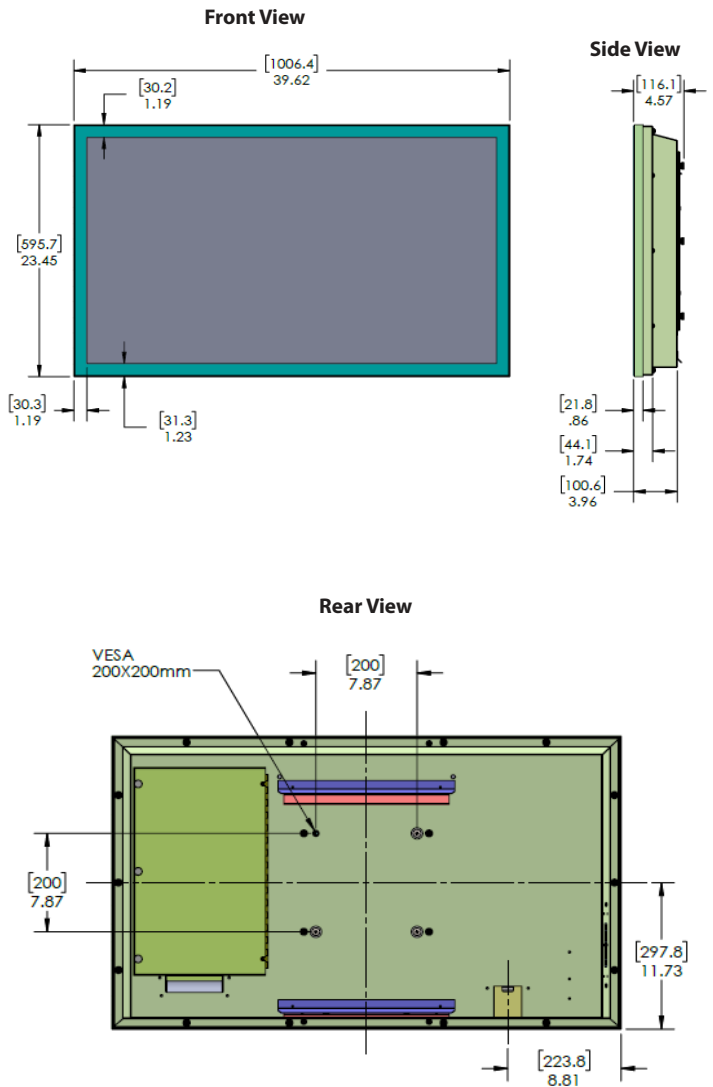

TV intended to be fastened in place using, 4ea, M4 x 12mm screws and washers (100mm x 100mm pattern) or 4ea, M8 x 30mm screws and washers and a UL listed wall mount.

Specifications are subject to change. 04/19/2020

# Specifications

LCD Screen	49-inch diagonal Color Active Matrix TFT LED LCD
Resolution	3840 x 2160 UHD 4k
Aspect Ratio	16:9
Backlight Brightness - Surface Luminance, white	1000 nits (cd/m <sup>2</sup> )
Contrast Ratio	4000:1
Front Window	AG Laminate Glass
Response Time	8 milliseconds
TV formats	2160p*, 1080p, 1080i, 720p, 720i, 480p, 480i * using hdmi only
Input Connectors:	
Tuner	Antenna/CATV (ATSC/QAM/NTSC) x1
HDMI	HDMI Input x 2 (supports HDMI 2.0, HDCP 2.2, HDMI 1.4 & HDCP 1.4a)
Video Composite	Composite Video, L/R Audio Inputs x1
Video Component	YPbPr plus Stereo Audio x1 (using 3.5mm to RCA adapter - not included)
PC	15-pin D-sub VGA plus Stereo Audio
Ethernet	RJ45 - Single Cat5e/Cat 6 cable
HDBase-T	RJ45 - Single Cat5e/Cat 6 cable*
	*refer to detailed data sheet for supported resolutions, refresh, color depth and Cat5e/Cat 6 cable lengths.
Control Set	RS232 Serial, Discrete IR Control, Concealed rear IR Window, IP Control, OvrC
Audio Out	Digital Optical TosLink x 1 (fixed) Analog 1/8" headphone jack (variable)
Accessory DC Power Out	5vdc @ 3.5amps 1.3mm power jack or usb type A jack
Speaker Output	20-watt(10w x 2) Does not have internal speakers. Optional Speaker Bar not included.
Exterior	Powder-coated aluminum
Colors	Silver, Black and White
Input Power	100-240 VAC, 50-60 Hz 2.5A max
Operating Temp.	-24° to 122° F. (-31° to 50° C.) *
Non-op. Temp. (Off-mode with power applied)	-24° to 140° F. (-31° to 60° C.) The non-operating temperature feature requires power to be applied
Accessories Included	Water-resistant remote control
Dimensions	45 in W x 27 in H x 5.3 in D 1138mm W x 678mm H x 134mm D
Weight	TV 83 lbs / 38kgs Shipping weight 91 lbs / 41 kgs
Residential Warranty	Two year, in-factory, parts and labor
Commercial Warranty	Two year, in-factory, parts and labor
Mount Pattern	400 mm x 400 mm

## Model SB-P2-49-4K Pro 2 Series 4K Ultra HD Dimensions

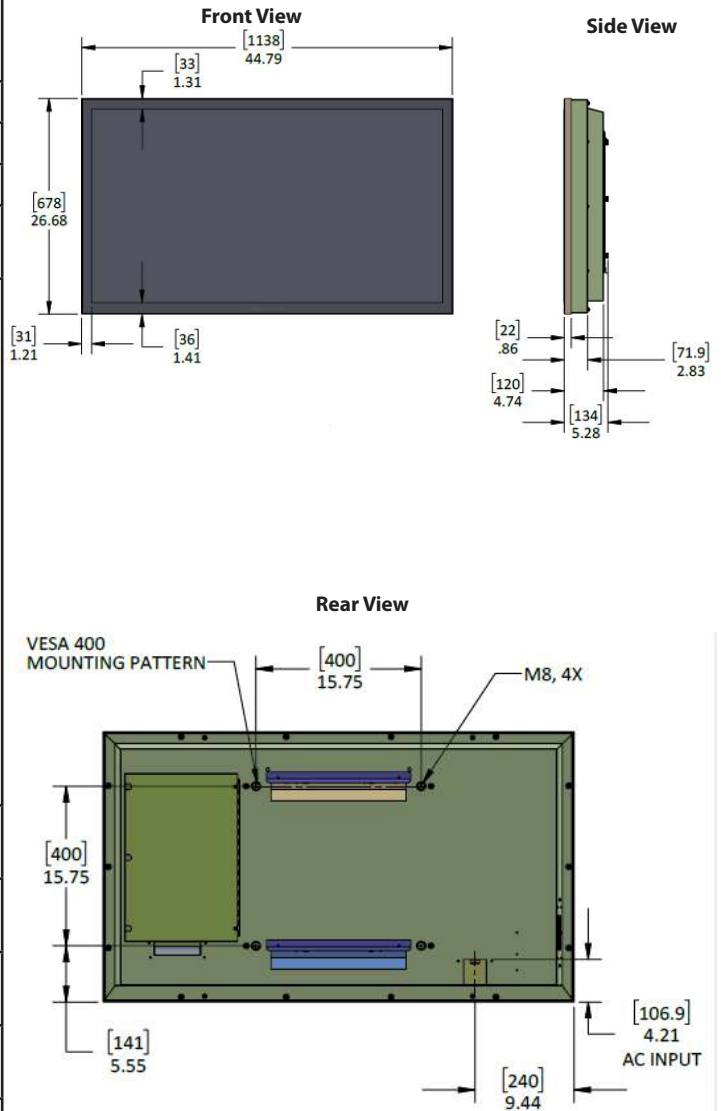

TV mounting

4ea, M8 x 30mm screws and washers (400mm x 400mm pattern)

Specifications are subject to change 04/19/2020



# Specifications

LCD Screen	55-inch diagonal Color Active Matrix TFT LED LCD
Resolution	3840 x 2160 UHD 4k
Aspect Ratio	16:9
Backlight Brightness - Surface Luminance, white	1000 nits (cd/m <sup>2</sup> )
Contrast Ratio	4000:1
Front Window	AG Laminate Glass
Response Time	8 milliseconds
TV formats	2160p*, 1080p, 1080i, 720p, 720i, 480p, 480i * using hdmi only
Input Connectors:	
Tuner	Antenna/CATV (ATSC/QAM/NTSC) x1
HDMI	HDMI Input x 2 (supports HDMI 2.0, HDCP 2.2, HDMI 1.4 & HDCP 1.4a)
Video Composite	Composite Video, L/R Audio Inputs x1
Video Component	YPbPr plus Stereo Audio x1 (using 3.5mm to RCA adapter - not included)
PC	15-pin D-sub VGA plus Stereo Audio
Ethernet	RJ45 - Single Cat5e/Cat 6 cable
HDBase-T	RJ45 - Single Cat5e/Cat 6 cable*
	*refer to detailed data sheet for supported resolutions, refresh, color depth and Cat5e/Cat 6 cable lengths.
Control Set	RS232 Serial, Discrete IR Control, Concealed rear IR Window, IP Control, OvrC
Audio Out	Digital Optical TosLink x 1 (fixed) Analog 1/8" headphone jack (variable)
Accessory DC Power Out	5vdc @ 3.5amps 1.3mm power jack or usb type A jack
Speaker Output	20-watt(10w x 2) Does not have internal speakers. Optional Speaker Bar not included.
Exterior	Powder-coated aluminum
Colors	Silver, Black and White
Input Power	100-240 VAC, 50-60 Hz 2.5A max
Operating Temp.	-24° to 122° F. (-31° to 50° C.) *
Non-op. Temp. (Off-mode with power applied)	-24° to 140° F. (-31° to 60° C.) The non-operating temperature feature requires power to be applied
Accessories Included	Water-resistant remote control
Dimensions	49.38in W x 28.72in H x 3.66in D 1254mm W x 730mm H x 93mm D
Weight	TV 99 lbs / 45kgs Shipping weight 108 lbs / 49kgs
Residential Warranty	Two year, in-factory, parts and labor
Commercial Warranty	Two year, in-factory, parts and labor
Mount Pattern	400 mm x 400 mm

## Model SB-P2-55-4K Pro2 Series 4K Ultra HD Dimensions

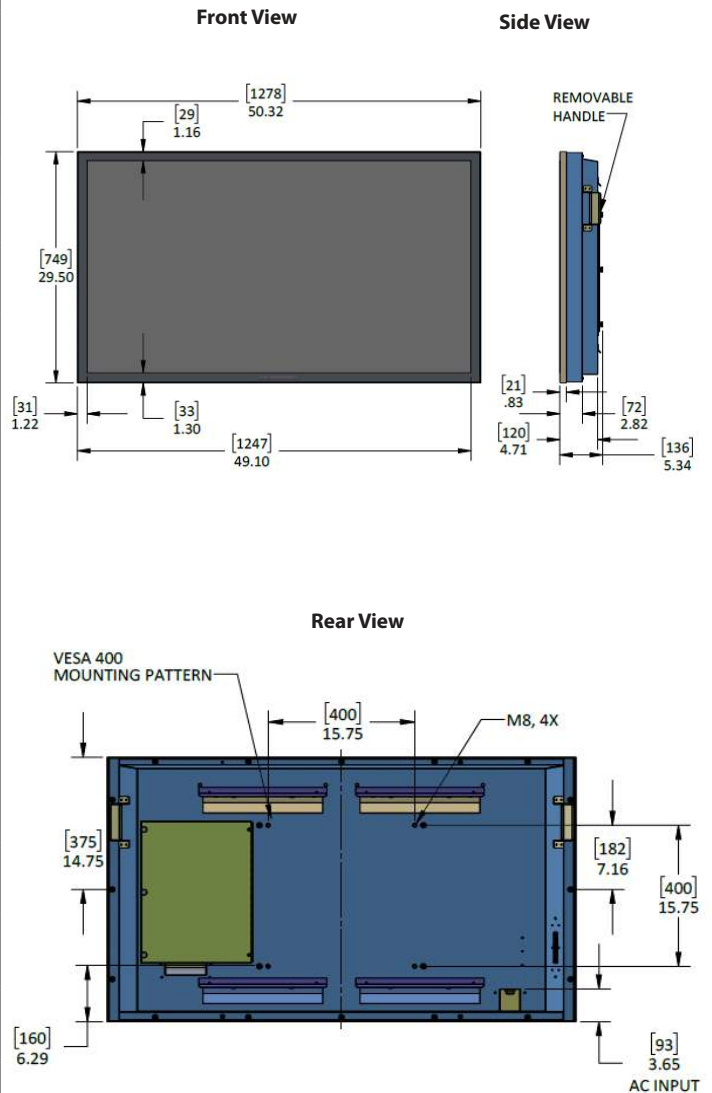

TV intended to be fastened in place using, 4ea, M6 x 30mm screws and washers (400mm x 400mm pattern) and a UL listed wall mount.

Specifications are subject to change 04/19/2020.



# Specifications

LCD Screen	65-inch diagonal Color Active Matrix TFT LED LCD
Resolution	3840 x 2160 UHD 4k
Aspect Ratio	16:9
Backlight Brightness - Surface Luminance, white	1000 nits (cd/m <sup>2</sup> )
Contrast Ratio	4000:1
Front Window	AG Laminate Glass
Response Time	8 milliseconds
TV formats	2160p*, 1080p, 1080i, 720p, 720i, 480p, 480i * using hdmi only
Input Connectors:	
Tuner	Antenna/CATV (ATSC/QAM/NTSC) x1
HDMI	HDMI Input x 2 (supports HDMI 2.0, HDCP 2.2, HDMI 1.4 & HDCP 1.4a)
Video Composite	Composite Video, L/R Audio Inputs x1
Video Component	YPbPr plus Stereo Audio x1 (using 3.5mm to RCA adapter - not included)
PC	15-pin D-sub VGA plus Stereo Audio
Ethernet	RJ45 - Single Cat5e/Cat 6 cable
HDBase-T	RJ45 - Single Cat5e/Cat 6 cable*
	*refer to detailed data sheet for supported resolutions, refresh, color depth and Cat5e/Cat 6 cable lengths.
Control Set	RS232 Serial, Discrete IR Control, Concealed rear IR Window, IP Control, OvrC
Audio Out	Digital Optical TosLink x 1 (fixed) Analog 1/8" headphone jack (variable)
Accessory DC Power Out	5vdc @ 3.5amps 1.3mm power jack or usb type A jack
Speaker Output	20-watt(10w x 2) Does not have internal speakers. Optional Speaker Bar not included.
Exterior	Powder-coated aluminum
Colors	Silver, Black and White
Input Power	100-240 VAC, 50-60 Hz 3.5A Max
Operating Temp.	-24° to 122° F. (-31° to 50° C.) *
Non-op. Temp. (Off-mode with power applied)	-24° to 140° F. (-31° to 60° C.) The non-operating temperature feature requires power to be applied
Accessories Included	Water-resistant remote control
Dimensions	60in W x 34.4in H x 5.4in D 1495mm W x 873mm H x 137mm D
Weight	TV 125 lbs / 57kgs Shipping weight 135 lbs / 61 kgs
Residential Warranty	Two year, in-factory, parts and labor
Commercial Warranty	Two year, in-factory, parts and labor
Mount Pattern	400 mm x 400 mm

## Model SB-P2-65-4K Pro2 Series 4K Ultra HD Dimensions

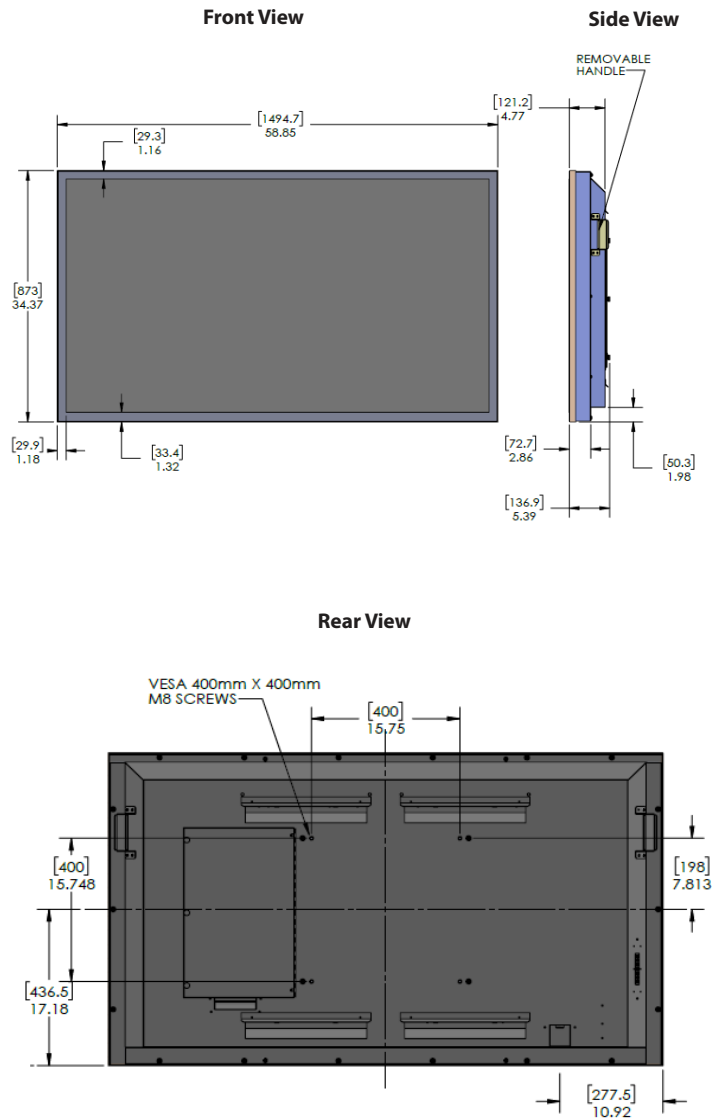

TV intended to be fastened in place using, 4ea, M6 x 30mm screws and washers (400mm x 400mm pattern) and a UL listed wall mount.

Specifications are subject to change. 04/19/2020

### **Programming Other Manufacturers' Universal Remote Control Devices**

---

When programming a DirectTV, local cable universal remote control or Control system, you may find that SunBriteTV may not be on the list of TV manufacturers. If that is the case, your SunBriteTV supports SONY's universal remote code.

### **SunBriteTV Pixel Quality Policy**

---

#### **SunBriteTV's Pixel Quality Policy**

(Applicable to LCD TVs sold within USA and Canada only.)

SunBriteTV LCD screens are manufactured with rigorous standards to maintain optimal viewing. However, the LCD screen may have minor defects that appear as a small bright or dark pixel. This is common to all LCD screens used in display and television products, and is not specific to SunBriteTV.

Bright dots are dots that appear bright and unchanged in size when a LCD TV screen displays a black pattern.

Dark dots are dots that appear dark and unchanged in size when a LCD TV screen displays a pure red, green, or blue pattern.

Adjacent dots are pixels located directly next to each other.

**Your SunBriteTV will be replaced under warranty if it meets one of the following criteria:**

- A total of 7 defective pixels, including both bright dots and dark dots are present. (This LCD screen has over a million pixels.)
- 2 or more pairs of adjacent bright dots are present.
- 3 adjacent bright dots are present.
- 3 adjacent dark dots are present.

To locate defective pixels, the LCD panel should be examined under normal operating conditions, in its native display resolution, with a 90 degree viewing angle, from a distance of approximately 20 inches.

**To qualify for replacement, a defective LCD screen must be reported to SunBriteTV within 60 days from the day the customer receives the TV.**

For questions, please call our Customer Care Center at 866-357-8688.

---

### **Extreme Climate Warning**

If temperatures below -24° F. are expected, we recommend that you bring your SunBriteTV inside to prevent damage to the LCD screen.

## IR Emitter Installation

### To install the IR Emitter:

The photo to the right shows an IR Emitter\* installed.

The end of the Emitter is to be mounted in front of the IR Emitter Window.

Place the emitter on the white tie-down block and use the tie-down to secure it in place.

Place the emitter cable over the bottom of the cable box and connect the other end of the emitter to the appropriate control block\*.

**Note it may be necessary to use a small amount of glue to secure the IR emitter in place as most IR emitters dual stick tape does not adhere well to powder coated surfaces. Use a small amount of glue or RTV (Silicon) to secure the emitter in place yet allowing it to be removed or replaced.**

Follow instructions on page 8 to close the cable door.

*\* Neither the emitter or control block are supplied by SunBriteTV. See instructions that come with your IR Emitter and control block to determine how to make the connections.*

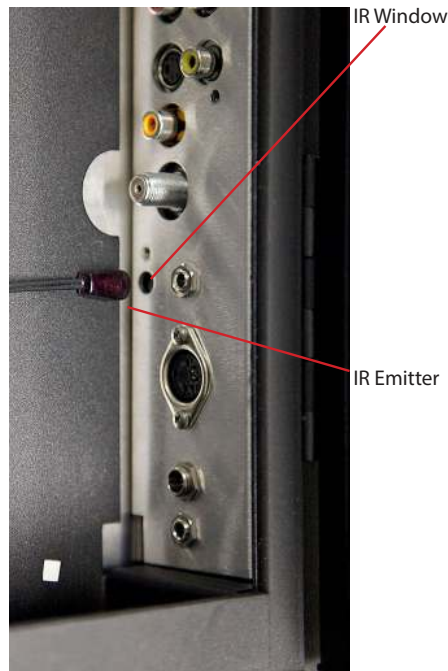

Place IR Emitter Cable over the bottom of the cable door.

## Appendix A - RS232 Control Cable Pinout

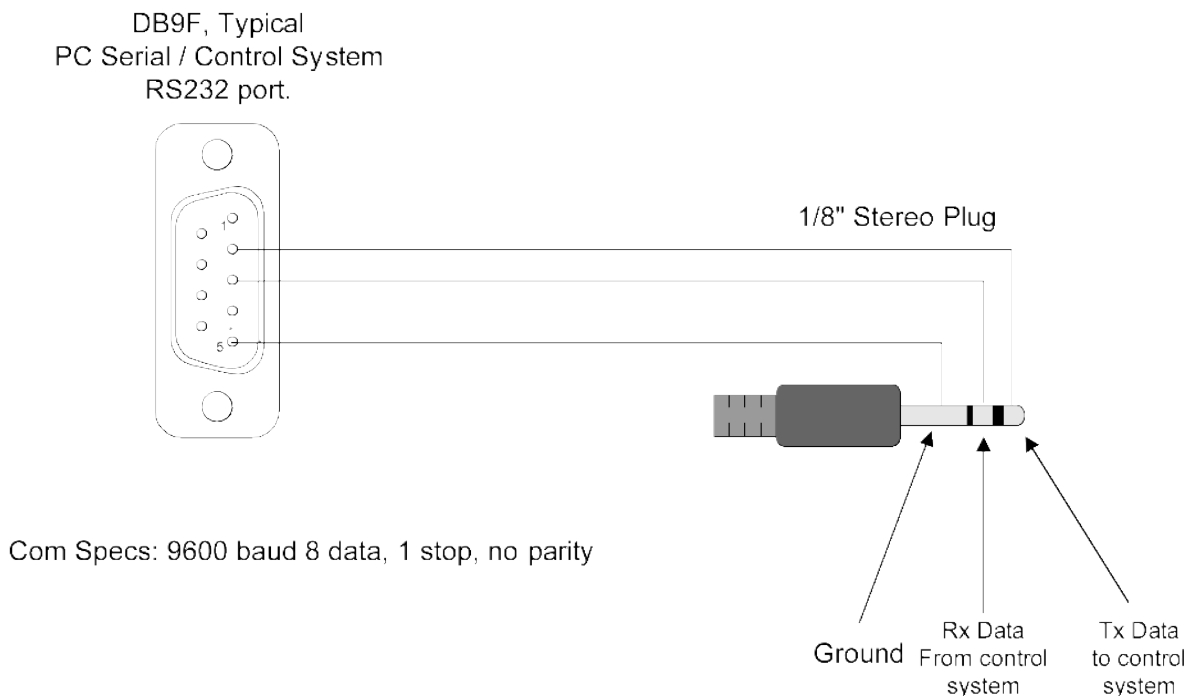

# Appendix B - RS232 Control Codes

## RS 232 Control codes SunbriteTV

Rev. 05/31/2016

Com Spec: 9600,8,1,n

Function	ASCII	HEX	Command Received Response from TV to control system	Command Executed Response from TV to control system
Model Class ID	[ESC]?	1B 3F	[B3220AHD-X.XX] or [B4610AHD-X.XX]	na
Firmware Version	[ESC]?	1B 2E	XXXXX-X.XX	main board followed by version
Power Status	[ESC]!	1B 21	[PWRON] [PWROFF]	na
Power Toggle	[ESC]\$	1B 24	[\$]	[PWR]
Power ON	[ESC]A	1B 41	[A]	[PWRON]
Power OFF	[ESC]B	1B 42	[B]	[PWROFF]
Input 10 - Tuner	[ESC]C	1B 43	[C]	[TN1]
Input 1 - AV	[ESC]D	1B 44	[D]	[AV]
Input 2 - NA	[ESC]E	1B 45	[E]	[N/A]
Input 3 - HDBaseT	[ESC]F	1B 46	[F]	[HDBaseT]
Input 4 - USB	[ESC]G	1B 47	[G]	[USB]
Input 5 - Component1	[ESC]H	1B 48	[H]	[Component 1]
Input 6 - Component2	[ESC]I	1B 49	[I]	[Component2]
*Input 7 -VGA	[ESC]K	1B 4B	[K]	[VGA]
*Input 8 - HDMI1	[ESC]J	1B 4A	[J]	[HDMI1]
Input 9 - HDMI2	[ESC]L	1B 4C	[L]	[HDMI2]
Mute	[ESC]X	1B 58	[X]	[MUTE]
Vol Up	[ESC]Y	1B 59	[Y]	[VOL+]
Vol Down	[ESC]Z	1B 5A	[Z]	[VOL-]
Channel Up	[ESC]V	1B 56	[V]	[CH+]
Channel Down	[ESC]W	1B 57	[W]	[CH-]
1	[ESC]1	1B 31	[1]	na
2	[ESC]2	1B 32	[2]	na
3	[ESC]3	1B 33	[3]	na
4	[ESC]4	1B 34	[4]	na
5	[ESC]5	1B 35	[5]	na
6	[ESC]6	1B 36	[6]	na
7	[ESC]7	1B 37	[7]	na
8	[ESC]8	1B 38	[8]	na
9	[ESC]9	1B 39	[9]	na
0	[ESC]0	1B 30	[0]	na
-	[ESC]-	1B 2D	[-]	na
Channel Return(Previous Channel)	[ESC]r	1B 72	[r]	na
Source Toggle	[ESC]b	1B 62	[b]	na
Aspect	[ESC]a	1B 61	[a]	na
Enter	[ESC]e	1B 65	[e]	na
Info	[ESC]i	1B 69	[i]	na
CC	[ESC]c	1B 63	[c]	na
Sleep	[ESC]z	1B 7A	[z]	na
Picture	[ESC]p	1B 70	[p]	na
Sound	[ESC]s	1B 73	[s]	na
Menu	[ESC]m	1B 6D	[m]	na
Up Arrow	[ESC]^	1B 5E	[^]	na
Down Arrow	[ESC]v	1B 76	[v]	na
Left Arrow	[ESC]>	1B 3E	[>]	na
Right Arrow	[ESC]<	1B 3C	[<]	na
Picture Mode 1 - Personal	[ESC]P	1B 50	[P]	na
Picture Mode 2 - Standard	[ESC]Q	1B 51	[Q]	na
Picture Mode 3 - SunBrite Day	[ESC]R	1B 52	[R]	na
Picture Mode 4 - Sunbrite Night	[ESC]S	1B 53	[S]	na

***SunBriteTV***<sup>®</sup>  
True Outdoor Television

[www.sunbritetv.com](http://www.sunbritetv.com)