

Outdoor Furniture



IMPORTANT

If you have any problems with this product (missing or damaged parts, assembly issues, etc.),

PLEASE DO NOT RETURN TO THE RETAILER/STORE

where you purchased the product.

Please call our Toll-Free Customer Service Hotline at: **1-866-988-3300**

Between 8:00 AM and 5:00 PM Pacific Standard Time, Monday through Friday

To expedite any future warranty claims, please retain the instruction sheet, warranty card and receipt for future use.

Care and Maintenance

Store furniture in an upright position. Be careful not to allow water to build up in frames, as this will cause corrosion and freeze damage in cold climates. Wash all frames with a solution of mild soap and water. Rinse with clean water and dry with a soft absorbent cloth towel. Frames can be treated with a liquid wax for maximum protection against UV rays and/or salty, damp air. If your set includes cushions, slings, and/or an umbrella, they may be cleaned by hand with a solution of soap and water with a clean water rinse. (Never machine wash cushions, slings or umbrella covers as this will result in shrinkage or damage). After cleaning cushions, tip on end and allow to drip dry. (Never use a commercial or home dryer to tumble dry fabric goods). Do not use bleach or solvents to clean any product! This will void the warranty.

Outdoor Furniture

1-Year Limited Warranty Program

For a period of one (1) year after date of purchase, the Manufacturer will either repair or replace defective components in accordance with this Limited Warranty. This warranty is between the Manufacturer and the original purchaser and is valid only when accompanied by the original purchaser's sales receipt showing original date of purchase and location of purchase. Replacements under this warranty revert back to the date of original purchase for future warranty.

The Manufacturer or its authorized dealer can accept or reject warranty claims based on its findings. This warranty applies in normal residential use only and is not intended for commercial use. The Manufacturer can make substitutions as required of materials, components, and sub-components of comparable value and utility. This warranty is limited to product repair or replacement (to be determined solely by the Manufacturer). Warranty return is limited to only the single affected component.

This limited warranty covers only manufacturing defects and does not cover normal wear and tear, damage due to acts of nature (such as, but not limited to freezing or high winds), abuse or misuse, including chemical damage from suntan oil or other chemicals, exposure to extreme heat or cold, abrasion or excessive weight. This product is intended to be used in standard installations only. This warranty is void if the product is not used for its intended purpose. The Manufacturer disclaims liability for any aspect of installation and any inconvenience caused by a defective part of a component.

Certain items are not covered by this warranty. These include, but are not limited to the following:

1. Components subjected to abuse, including abuse intended to simulate failure.
2. Damages caused by retailer, shipper or installation crew (such as scratches, dents, tears, chips, etc.).
3. Any part that merely exhibits normal wear yet functions essentially as new, including chips, scratches or stretching of materials and stitching.
4. Tears, punctures, scratches or any damage caused by improper installation or use.
5. Damage to frames/welds resulting from improper assembly or exposure to water and/or sub-freezing temperatures is not covered. General frame rusting is not covered.
6. Fading and/or discoloration of fabrics/cushions/straps/wicker resulting from exposure to the elements, chemicals, oils, fluids or any other cause are not covered.
7. Umbrella bases are not covered under any circumstances.
8. Items sold "as is" or floor models.

To make a claim, call the toll-free number below. Please have available a copy of the original sales receipt along with a brief description of the problem. Please also provide your email address and daytime telephone or cell phone number. All items may be charged actual freight costs plus \$15 for handling. Repairs or replacement will be made at the Manufacturer's option. ***Sales and use taxes, plus shipping and handling charges are the responsibility of the consumer.***

THIS IS THE ENTIRE EXCLUSIVE EXPRESS LIMITED LIABILITY. THE MANUFACTURER NEITHER MAKES NOR IS RESPONSIBLE FOR ANY OTHER WARRANTIES, EITHER EXPRESS OR IMPLIED, INCLUDING THOSE OF RETAILING DEALERS. THIS EXCLUSIVE REMEDY IS LIMITED TO RECEIPT OF A CREDIT IN CONNECTION WITH THE REPAIR OR REPLACEMENT OF ANY PRODUCT OR COMPONENT DEEMED TO BE DEFECTIVE UNDER THE TERMS AND CONDITIONS AS STATED IN THIS WARRANTY. NEITHER THE PRODUCT MANUFACTURER NOR ITS AGENTS SHALL BE LIABLE IN ANY CASE FOR INCIDENTAL, INDIRECT, SPECIAL OR CONSEQUENTIAL DAMAGES RESULTING FROM THE USE OF THIS PRODUCT OR ARISING OUT OF ANY BREACH OF THIS WARRANTY OR NEGLIGENCE EVEN IF IT HAS BEEN ADVISED OF THE POSSIBILITY OF SUCH DAMAGES. EXCEPT AS OTHERWISE MAY BE REQUIRED BY LAW, THERE ARE NO OTHER EXPRESS OR IMPLIED WARRANTIES OTHER THAN THE WARRANTY DESCRIBED HEREIN, AND ALL OTHER WARRANTIES, INCLUDING ANY IMPLIED WARRANTY OF MERCHANTABILITY OR FITNESS FOR A PARTICULAR PURPOSE ARE EXPRESSLY DISCLAIMED.

Contact Customer Service at 1-866-988-3300

Assembly Instructions

GRM00696G

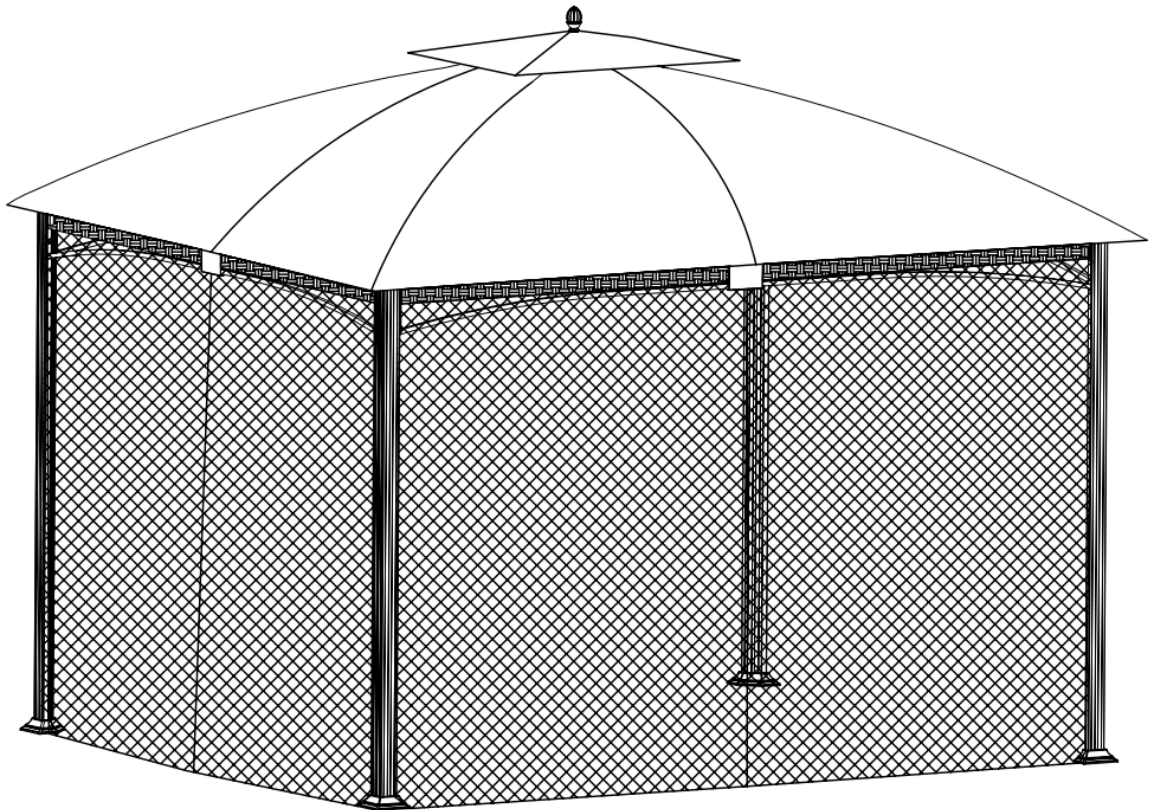















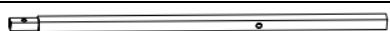
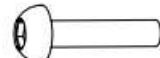



Aluminum and Steel Gazebo with Netting

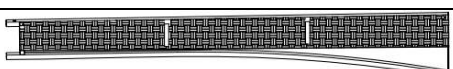



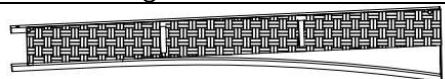



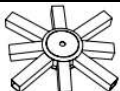

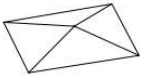
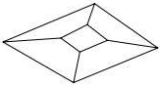

Questions, problems, or missing parts?
Before returning to the store, call Customer Service.

1-866-988-3300
8 a.m. -5 p.m., PST Monday - Friday

Retain this manual for future use.

Parts & Tools

PART	QTY	PICTURE & DESCRIPTION	PART	QTY	PICTURE & DESCRIPTION
A	4	 Post leg	V	28+2	 M6*15 mm screw
B	4	 Inclined tube 1	V1	8+1	 M6*20 mm screw
B1	4	 Inclined tube 2	V2	8+1	 M6*30 mm screw
C1	2	 Inclined tube 3	V3	24+2	 M6*45 mm screw
C2	2	 Inclined tube 4	V4	8+1	 Nut
D1	2	 Right long beam	W	2	 Inner allen wrench
D2	2	 Left long beam	X	1	 Allen wrench
D3	2	 Right short beam	Y	8	 Ground spike
D4	2	 Left short beam			
E1	4	 Long rail beam			
E2	4	 Short rail beam			
F	4	 Decorative plate			
G	1	 Top kit			

H	1	 Connector kit			
J	1	 Decorative kit			
K	4	 Middle kit			
L	4	 U-shape kit			
M	8	 Connector part			
N	1	 Small canopy			
O	1	 Large canopy			
P	44	 Q-shape split ring			
Q	4	 Leg base cover			<p>WARNING: To avoid damage of this production, please use either the carton or another soft surface such as carpet as a working surface to prevent product damage during assembly.</p> <p>Need for assembly:</p>  <p>2 people</p>
R	4	 Leg base			
S	16	 Rail beam washer			
T	4	 Net			
U	1	 Hook			

WARNING: Please keep children out of the assembly area before assembly.

WARNING: Do not leave the gazebo where there is a risk of high wind, as possible damage will occur to the structure.

WARNING: Keep all flame and heat sources away from the fabric.

CAUTION: Do not climb on the top of the gazebo. Falling off the gazebo can result in serious injury, possibly even death.

Gazebo Assembly

Step 1:

- Attach the U-shape kit (L) to post leg (A) using M6*15mm screw (V).
- Insert post leg (A) into the leg base cover (Q) as shown.
- Attach the leg base (R) to the post leg (A) using M6*15mm screw (V).
- Push the leg base cover (Q) to the bottom.

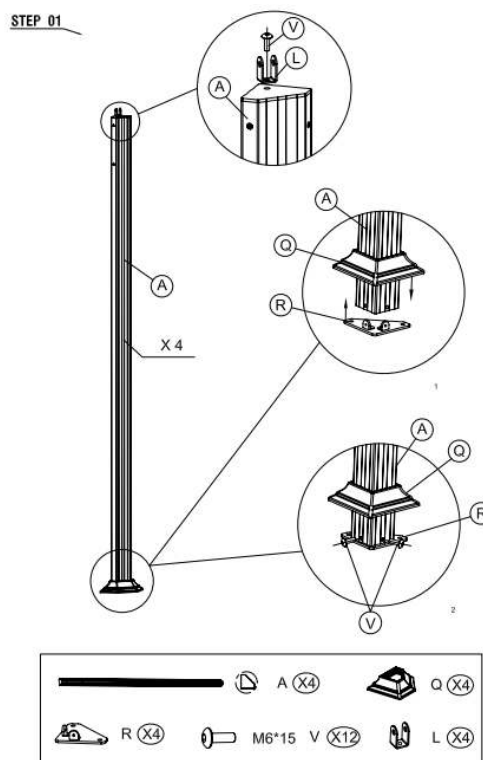

Step 2:

- On bottom side, attach the right long beam (D1) and the connector part (M) to the decorative plate (F) using M6*15mm screw (V) as shown.
- On top side, attach the Right long beam (D1) and the connector part (M) and middle kit (K) to the decorative plate (F) using M6*20mm screw (V1) as shown.
- Attach the left long beam (D2) to the connector part (M) using M6*20mm screw on the above side.

- Attach the left long beam (D2) to the connector part (M) using M6*15mm screw on the bottom side.

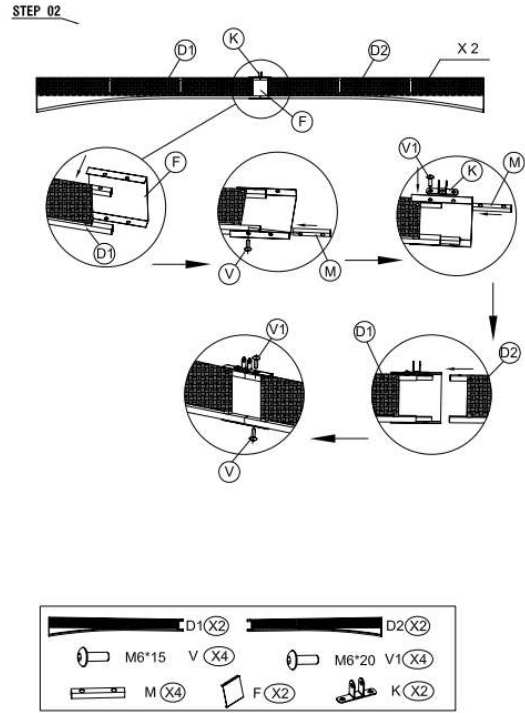

Step 3:

- Connect right short beam (D3) and left short beam (D4) according to step 2.

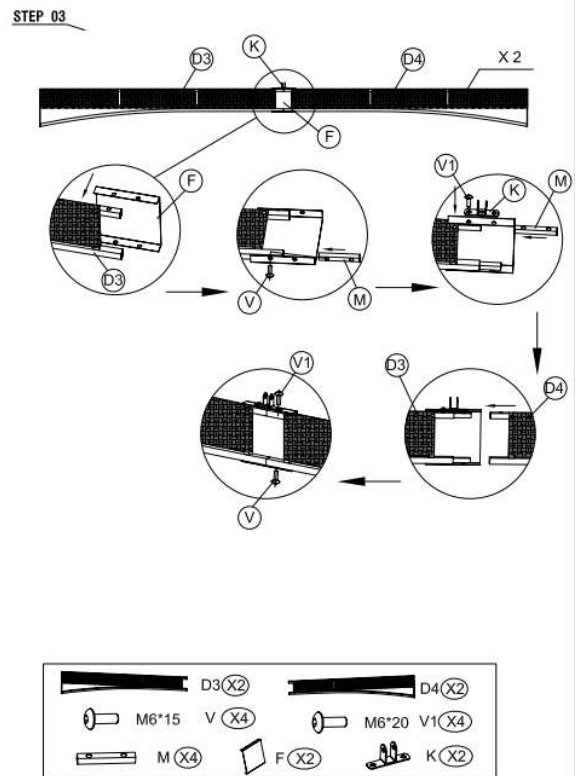

Step 4:

- Attach the beams (D1&D2) to the post leg (A) using M6*15mm screw (V) and M6*45mm screw (V3) as shown.

STEP 04

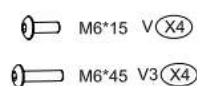
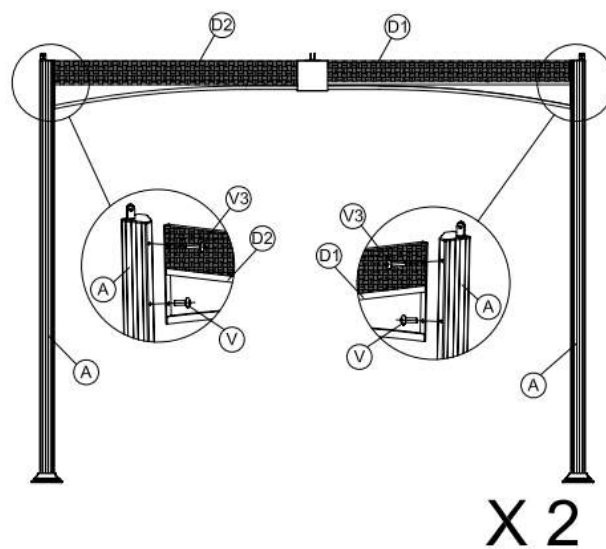

Step 5:

- Attach the beams (D3&D4) to post leg (A) using M6*15mm screw (V) and M6*45mm screw (V3) as shown.

STEP 05

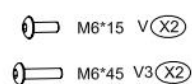
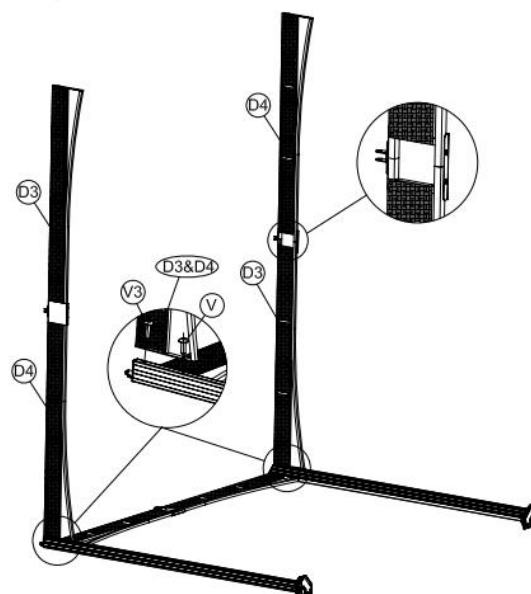

Step 6:

- Connect the frame as shown and tighten the screws.

STEP 06

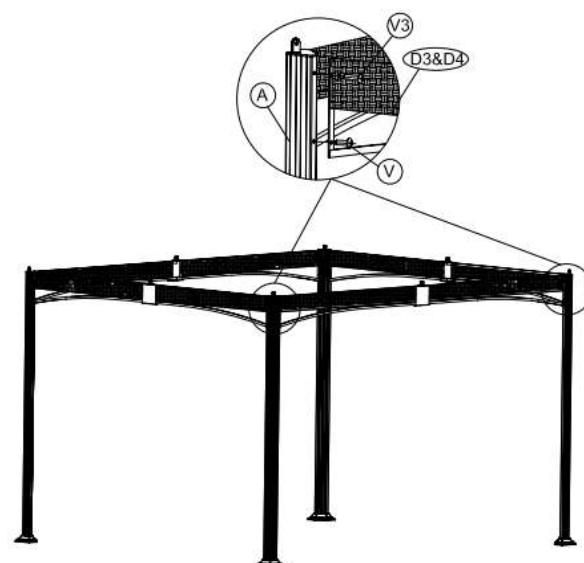

 M6*15 V(X2)

 M6*45 V3(X2)



8

Step 7:

- Insert inclined tube 1 (B), inclined tube 3 (C1), and inclined tube 4 (C2) into top kit (G) in the order of (B), (C1), (B), (C2), (B), (C1), (B), (C2).
- Insert the inclined tube 2 (B1) into the inclined tube 1 (B) as shown.

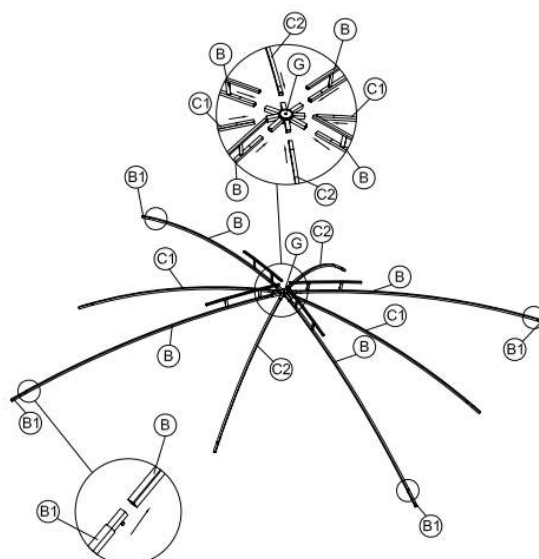
STEP 07



 B(X4)  B1(X4)

 C1(X2)  G(X1)

 C2(X2)

Step 8:

- Attach the inclined tube 2 (B1) to the U-shape kit using M6*30mm screw (V2) and nut (V4).
- Attach the inclined tube 3 (C1) and inclined tube 4 (C2) to the middle kit using M6*30mm screw (V2) and nut (V4).

STEP 08

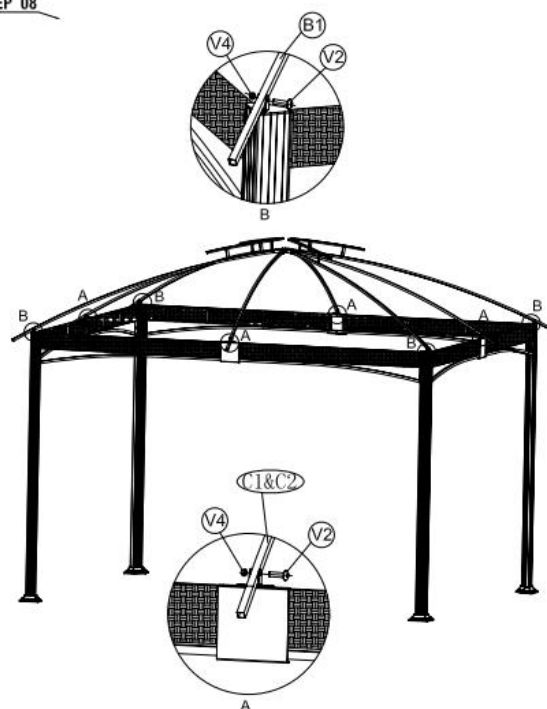

M6*30 V2 (X8)

M6 V4 (X8)

Step 9:

- Attach the connector kit (H) and the hook (U) to the top kit (G) by screwing clockwise.

STEP 09

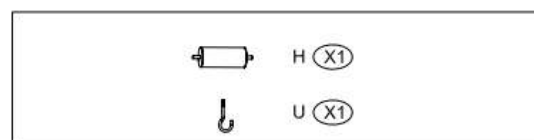
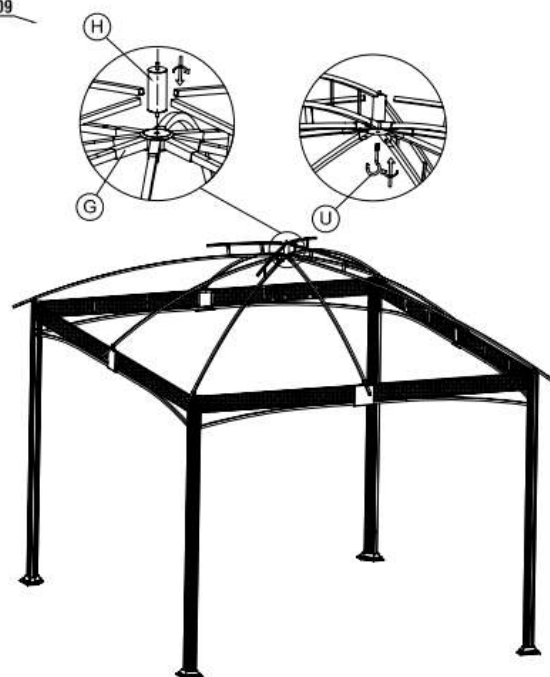
**Step 10:**

- Put the large canopy (O) on the frame as shown.

STEP 10

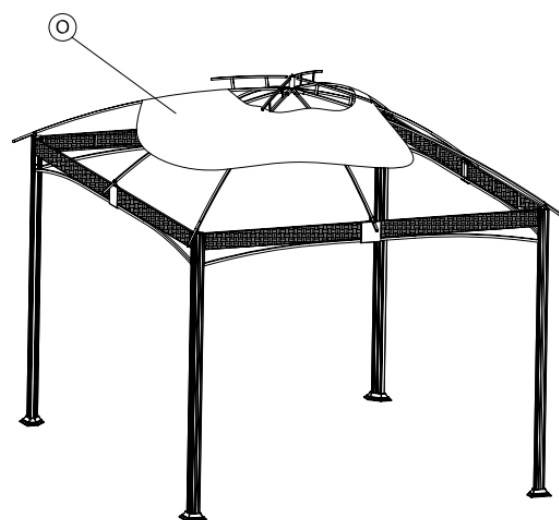
**Step 11:**

- Put the small canopy (N) on top and

tighten as shown.

- Attach the decorative kit on top by screwing clockwise.

STEP 11

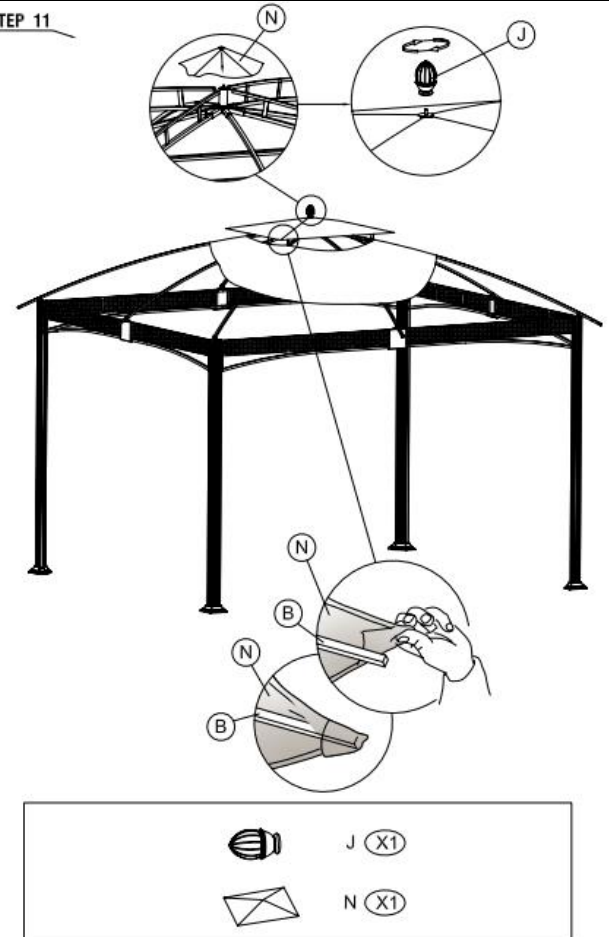

Step 12:

- Tighten the large canopy (O) as shown.

STEP 12

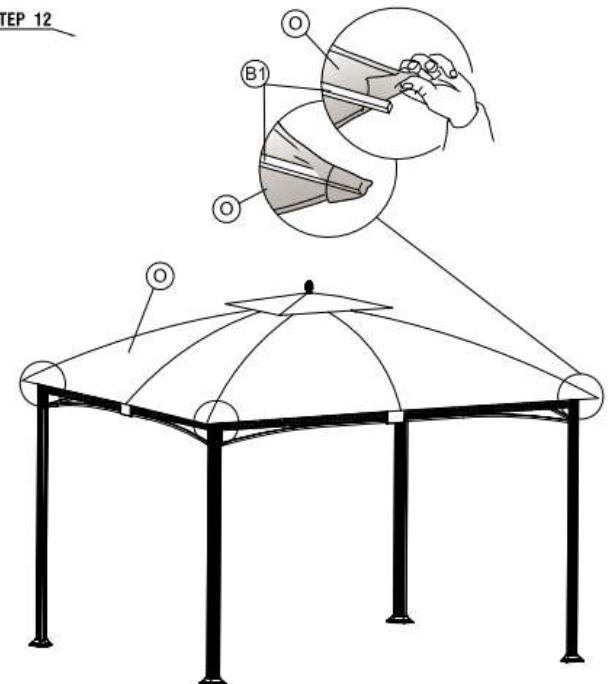

Step 13:

- Attach the long rail beam (E1) and short rail beam (E2) to the post leg (A) using M6*45mm screw (V3) and rail beam washer(S).
- Attach the long rail beam (E1) and short rail beam (E2) to the decorative plate using M6*45mm screw (V3) and rail beam washer(S).

STEP 13

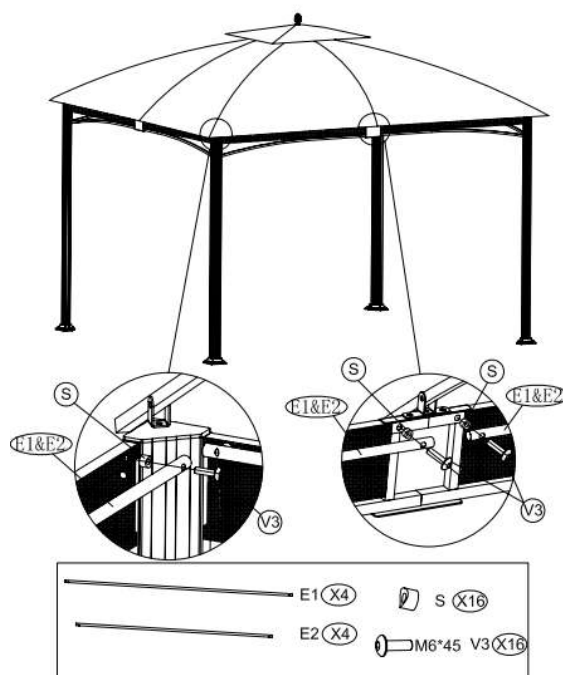

Step 14:

- Attach the net (T) to rail beams (E1&E2) using Q-shape split ring (P).
- Tighten the gazebo to the ground using ground spike (Y) .

STEP 14

