

# Robotic Cleaner Troubleshooting Guide



# Table of Contents

## TigerShark & TigerShark QC

Important safety instructions	Page 1
Service Tools	Page 2
Filter Removal/Cleaning and Drain Flaps	Pages 4-6
Handle Removal	Page 7
Venturi Removal	Page 8
Bottom Lid Disassembly	Pages 9-10
Side Cover Removal	Pages 11-12
Drive Track and Idlers	Pages 13-16
Power Cord and Motor Box	Pages 17-27
Wheel Tube Brush and Bearings	Pages 28-30
Using the Scanner Tool	Pages 31-34
Power Supply and Flotation Cord Testing	Page 35
Basic Operation	Pages 36-37
Troubleshooting	Pages 38-43

# Table of Contents Continued

## SharkVAC & E-Vac

Service Tools	Page 44
Power Supply	Page 45
Filter Removal	Pages 46-47
Filter Replacement	Page 48
Wheel and Tire Removal	Page 49
Side Cover Removal	Page 50
Drive Track and Idlers	Page 51
Main Drive Pulley Removal	Page 52
Wheel Tube Removal	Page 53
Wheel Tube Brush	Page 54
Power Cord Removal	Pages 55-60
Motor Box Removal	Pages 61-62
Power Supply and Flotation Cord Testing	Page 63
Troubleshooting	Pages 64-68

# Safety



## Warning - Risk of Injury

**Failure to follow the safety warnings below may result in severe injury, death or property damage.**

---

- Always place the machine in the water before connecting it to the electrical supply.
- Always connect the power supply to an approved GFCI, ground fault circuit interrupter.
- Do not handle machine while it is plugged into the electrical supply.
- Do not use an extension cord.
- Immediately remove the cleaner from the water after cleaning.
- Never allow swimmers in the pool while the cleaner is operating.
- Never allow plug or power supply unit to enter pool.
- Keep the power supply unit a safe distance from the pool edge and water.
- Keep the power supply unit dry and away from rain or other water spray.

# Service Tools

Pin Removal Tool

Torque Driver



Torx Bit

Spanner Tool

Torx Driver



Scanner

# Power Supply

On/Off Switch - Lighted

Quick Clean LED  
(QC Models Only)

Power Cord



Full Cycle Button  
and LED  
(QC Models Only)

Flotation Power Cord Connector

# Disassembly – Filter Removal

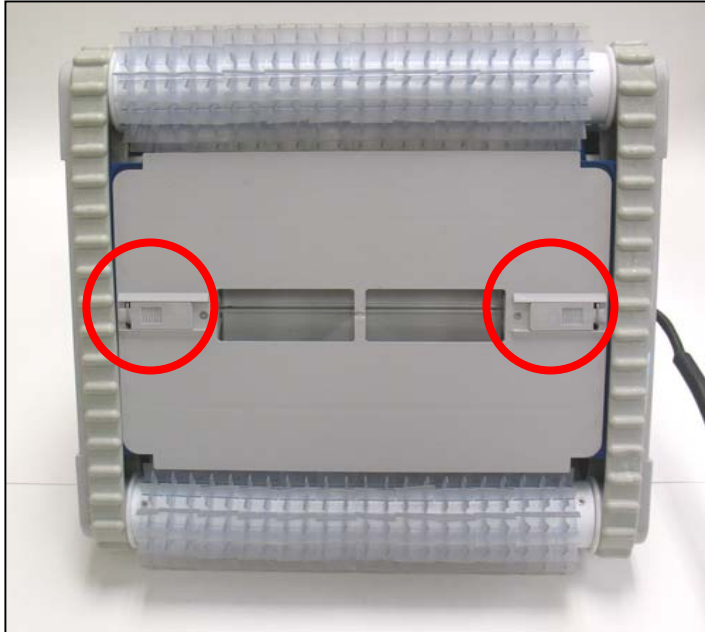

Remove bottom lid by sliding LH and RH latch towards center.



Bottom lid removed providing access to filter cartridge assembly

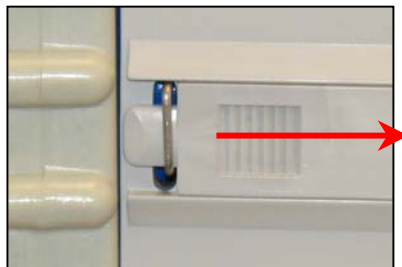

# Filter Removal

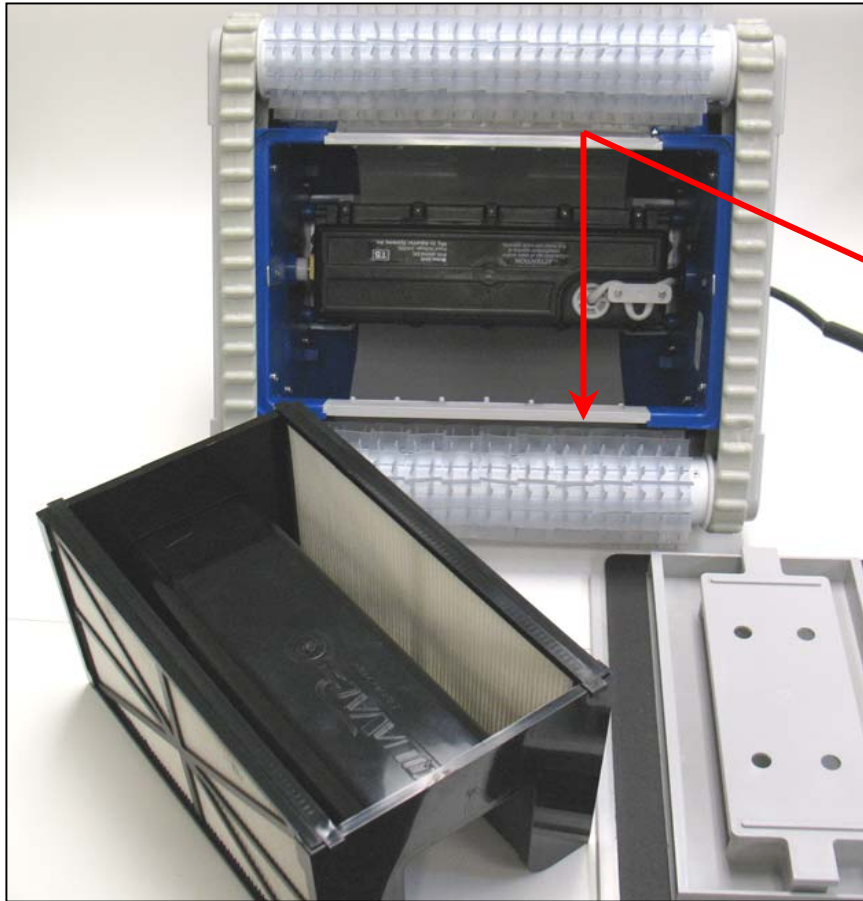

Filter cartridge removed

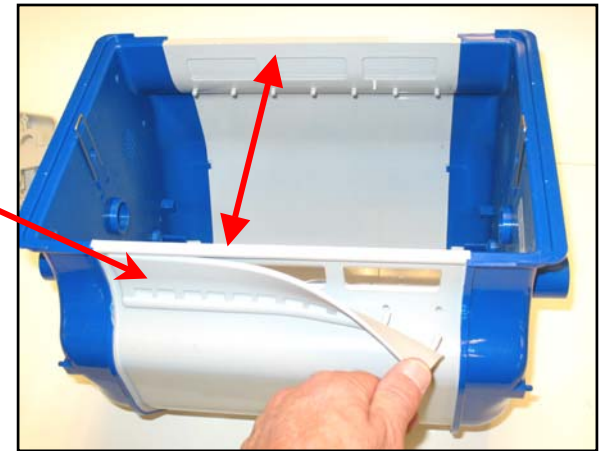

**Note the drain flaps, one per side. Not required to remove for filter cleaning, but visually inspect when filter is removed.**



# Filter Removal

**Note: Elements must be installed with support ribs facing outward**



Filter cartridge assembly

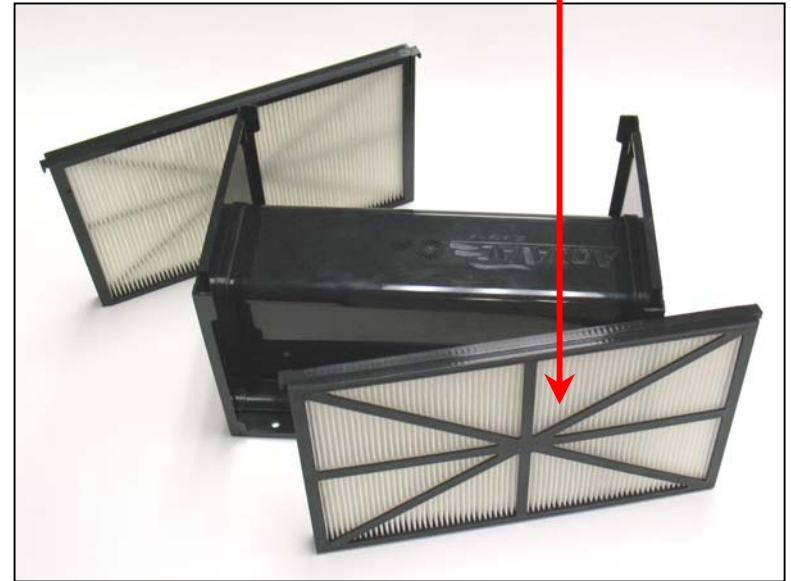

Filter elements removed

**Note: Elements can be cleaned by gently spraying with a garden hose. Be careful not to use high pressure or this may damage the element.**



**Spring cleanup filter elements. For temporary use in heavy spring cleaning.**

# Handle Removal



Handle removal  
1 screw each end



Handle removed

**Note:** Handle is watertight.  
If water is heard sloshing around  
in handle it must be replaced.

# Venturi Removal

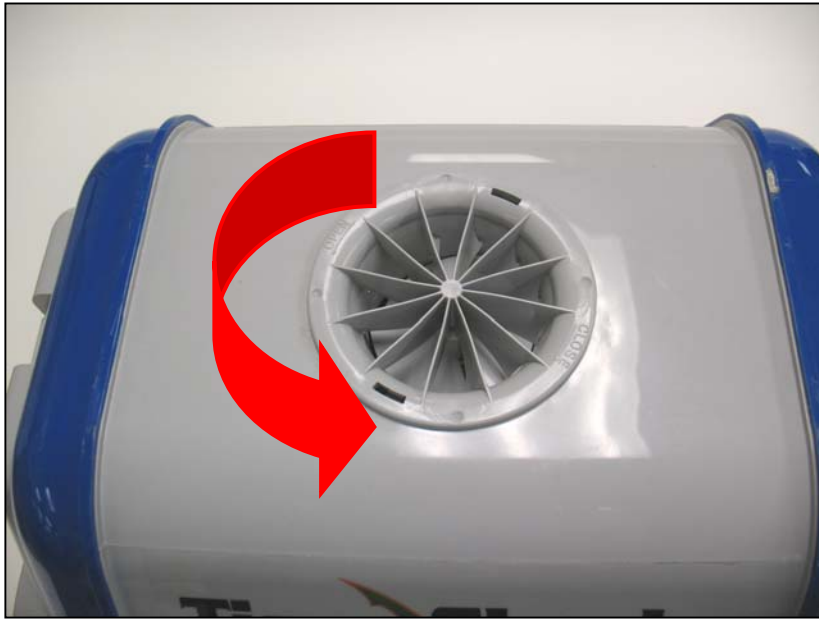

Rotate CCW & lift out



Removed, access to impeller

# Bottom Lid Disassembly

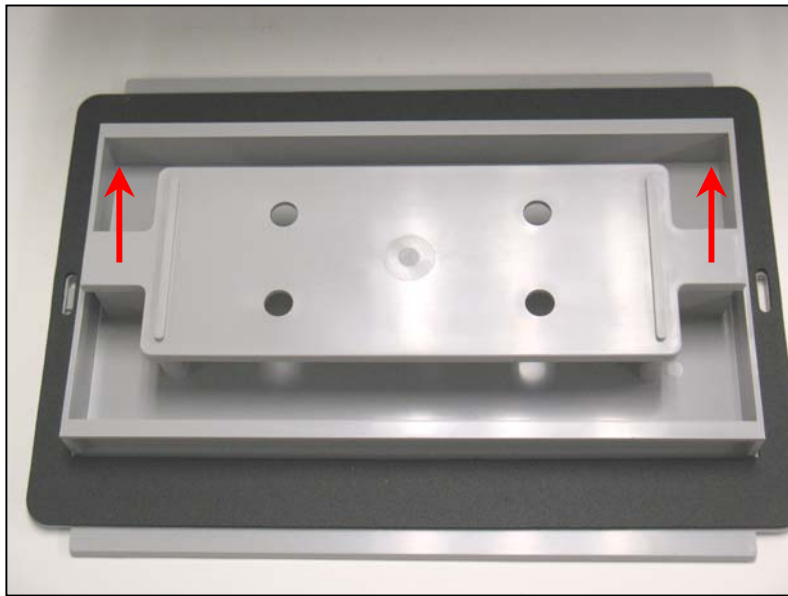

Bottom lid assembly. Pull up to remove inlet cover.



Inlet cover removed

# Bottom Lid Disassembly



Inlet flaps, check for free movement.

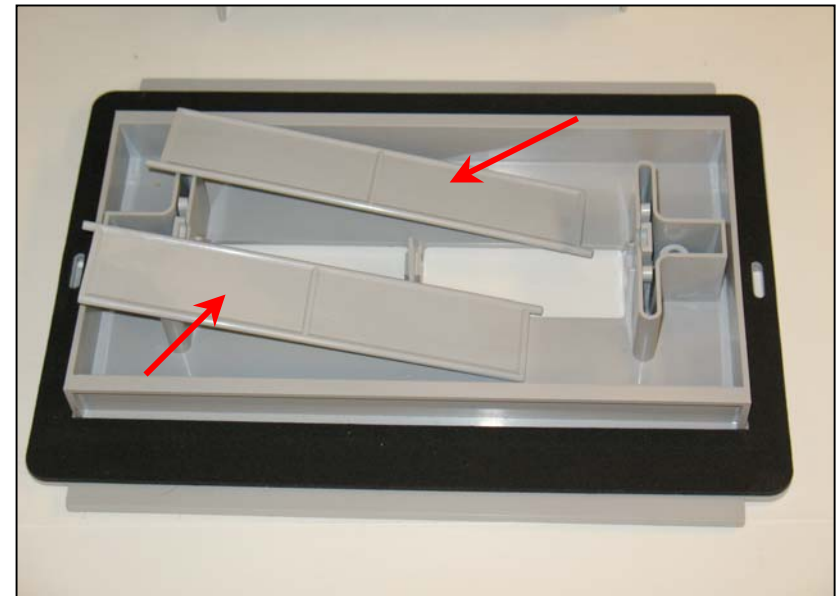

Inlet flaps removed for inspection.

# Side Cover Removal

Motor output shaft. Drive end.    Motor assembly    Power cord    Power cord end

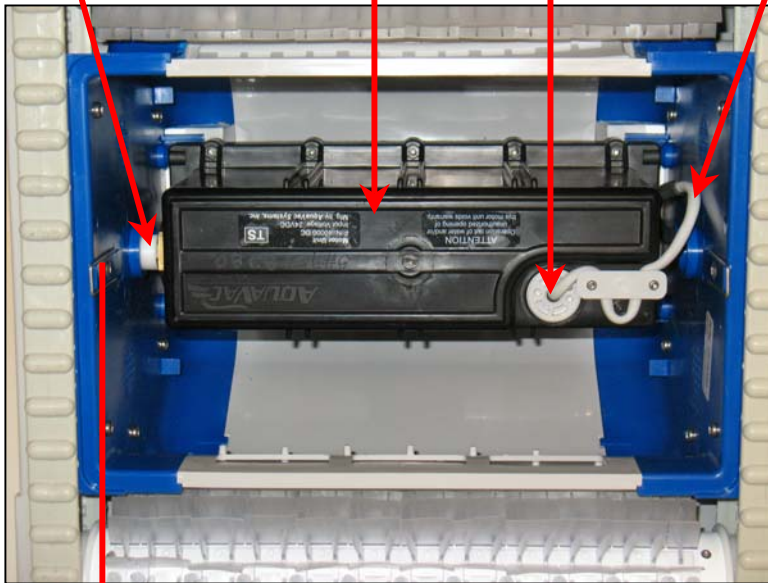

Bottom view with bottom lid and filter assembly removed.



Note: Use Torx bit and power driver for removal.

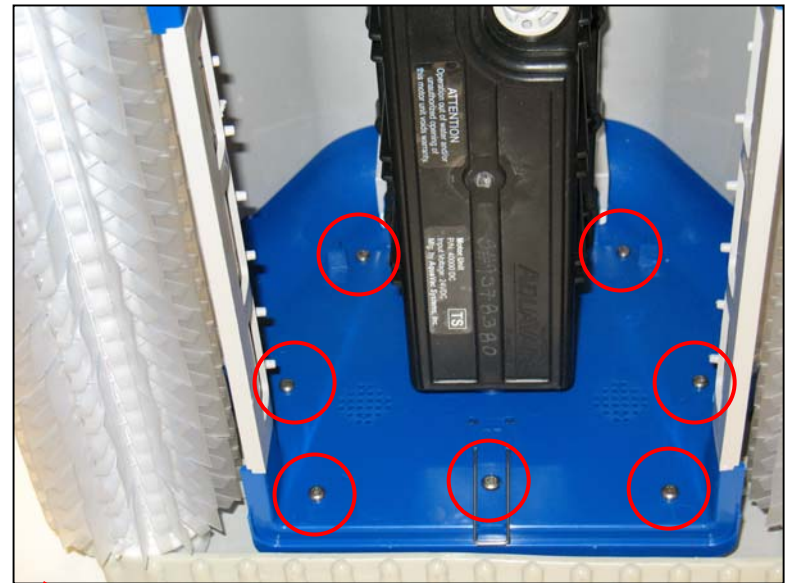

7 screws each end to remove for side plate removal, drive side.



Power cord end, 7 screws.

# Side Cover Removal



Screw removal

Note that 'drive side' or motor output side is side opposite of where power cord enters unit.

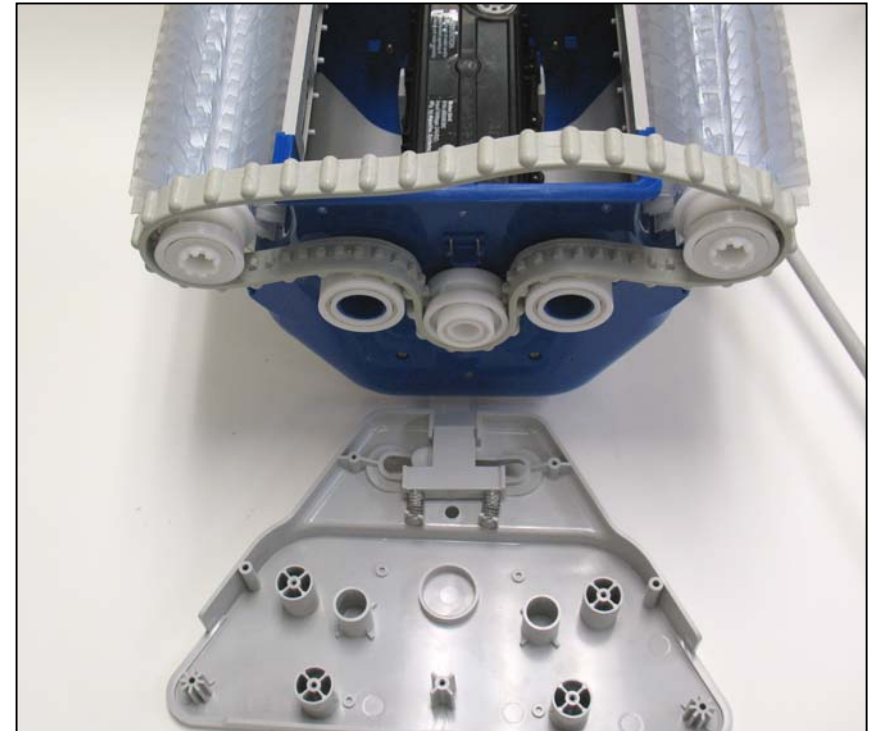

Side cover removed

# Drive Track & Idler Pulley Removal

Drive Side

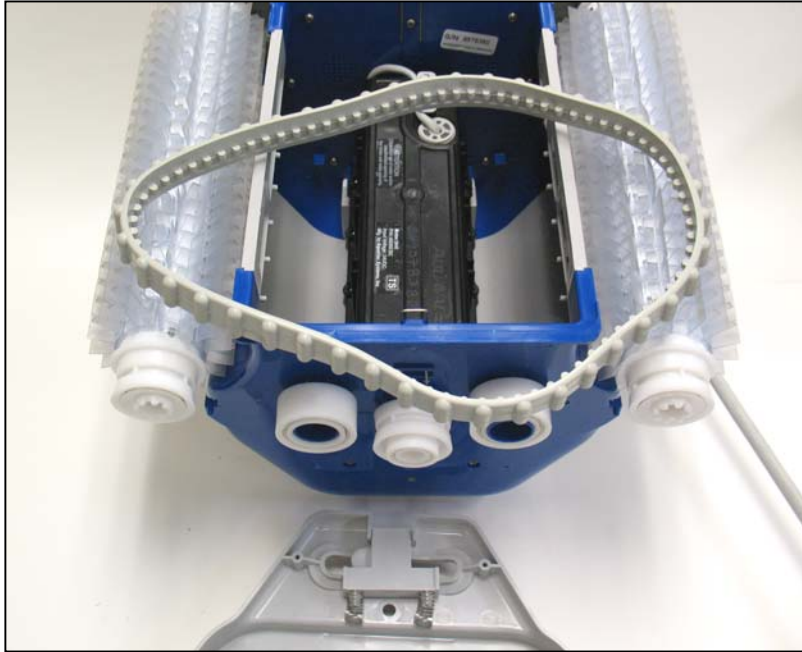

**Drive track removed**

Check for missing/broken drive cogs on inner loop of belt and also for cracks in belt.

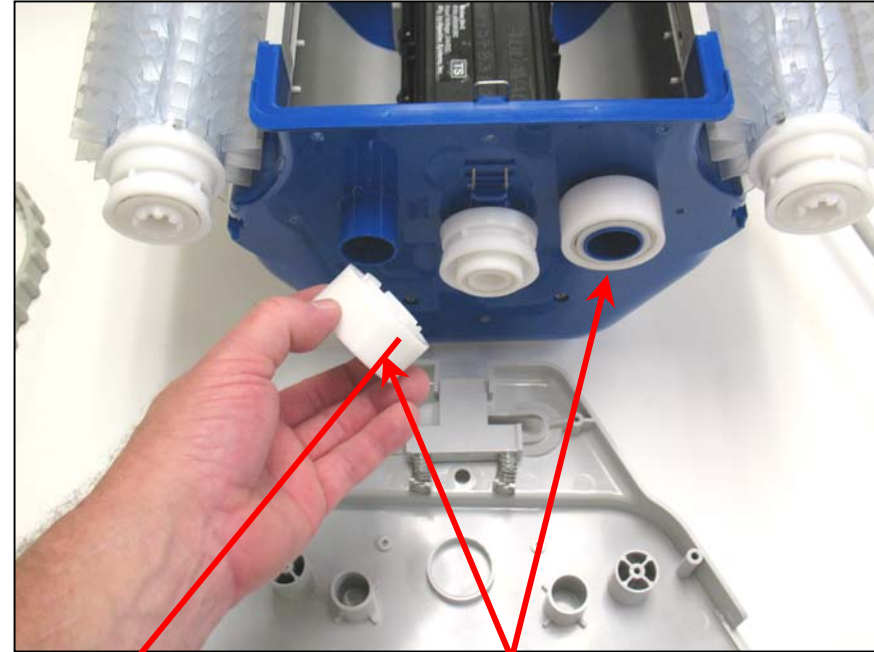

**Track idler pulley (2/side)**

Bearings should rotate smoothly and freely.

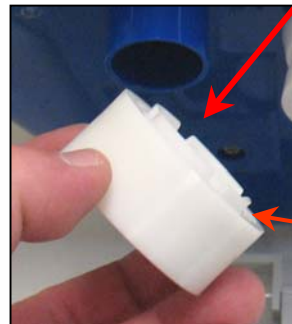

Note that flange faces inward.



# Main Drive Pulley Removal

Note drive 'key' in pulley and how it mates to the output shaft drive pin of the motor.

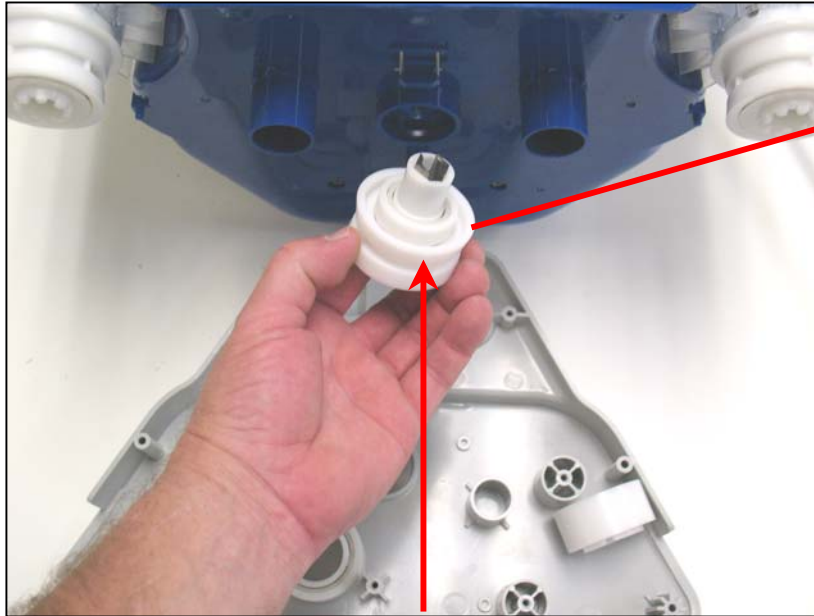

Main drive pulley, motor output side only

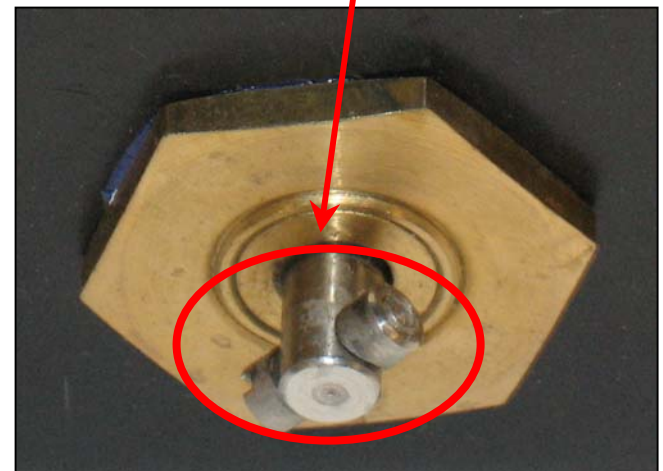
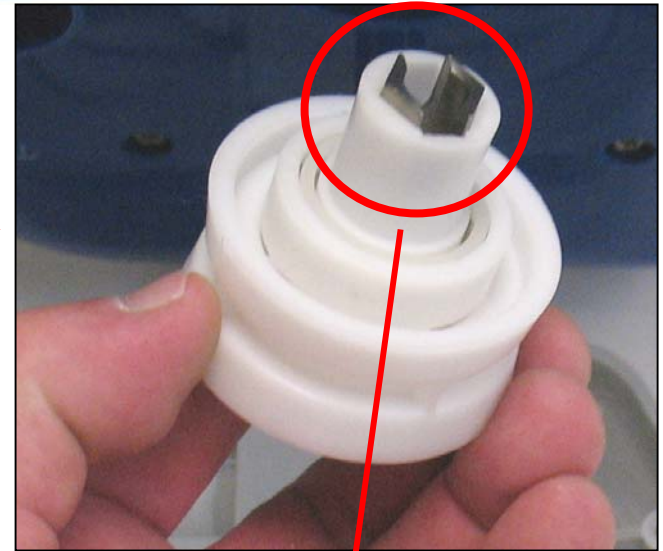

# Wheel Tube Removal

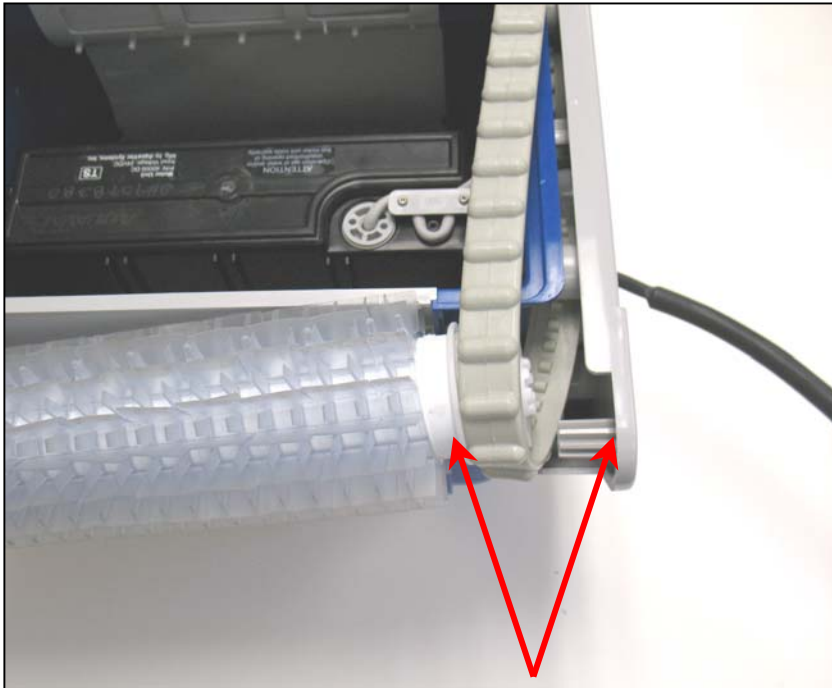

Carefully pull wheel tube away from other side plate. Roller will slide off track.



Both drive tubes removed.

# Drive Track & Idler Pulley Removal

## Non-drive Side



Screw removal, opposite side cover, non-drive side.

Track idler pulleys, (3). Note this side does not have a keyed drive pulley at the center pulley since it is opposite the motor drive end. This pulley is simply an idler pulley similar to the ones to the left and right.

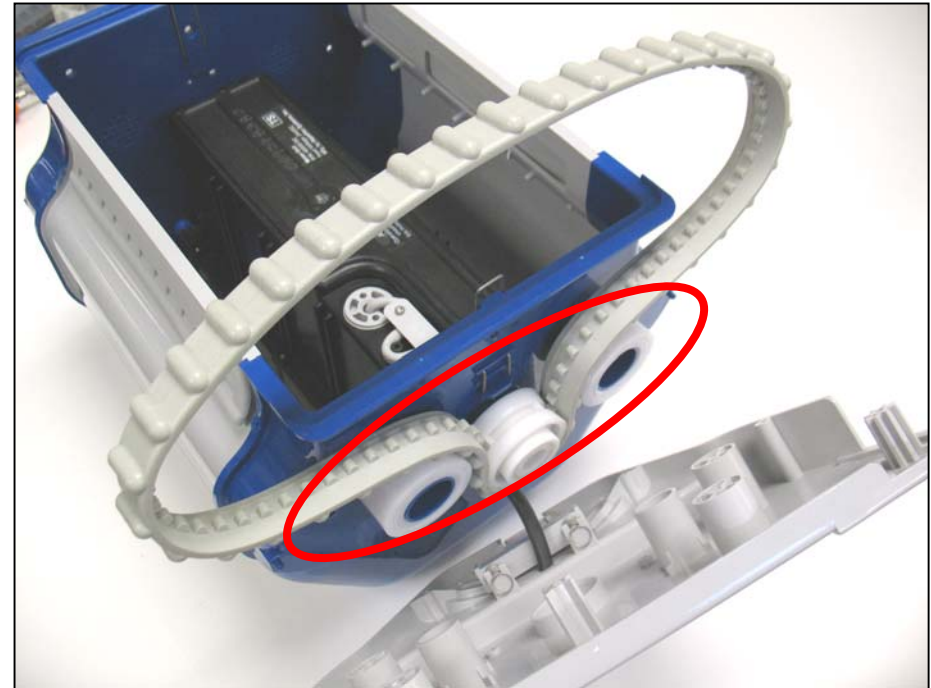

Side cover removed

# Power Cord & Motor Box Removal

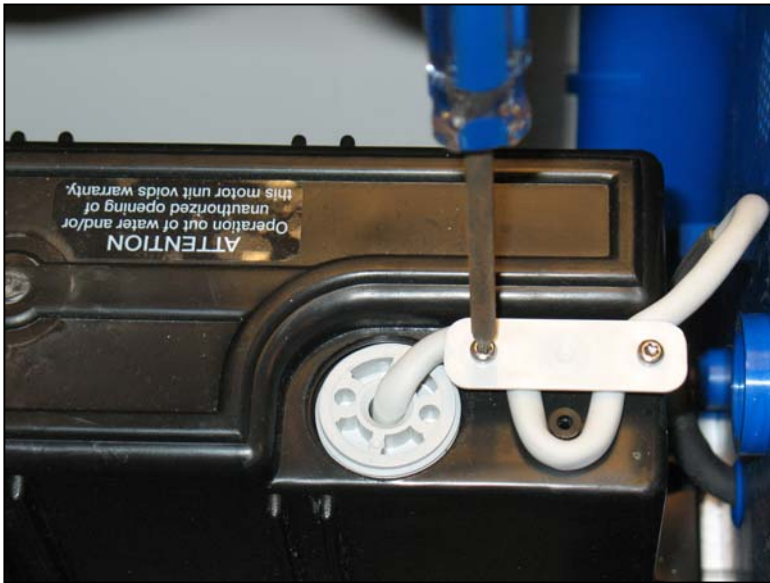

Remove strain relief cover plate.

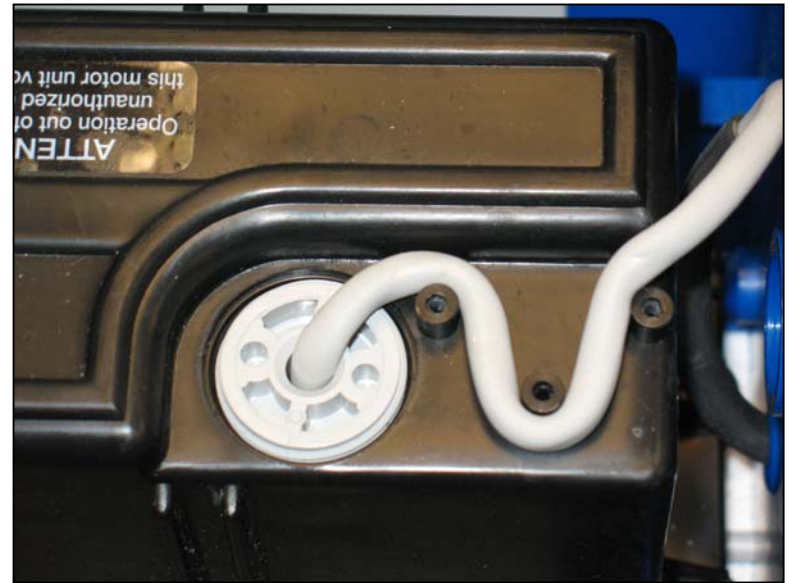
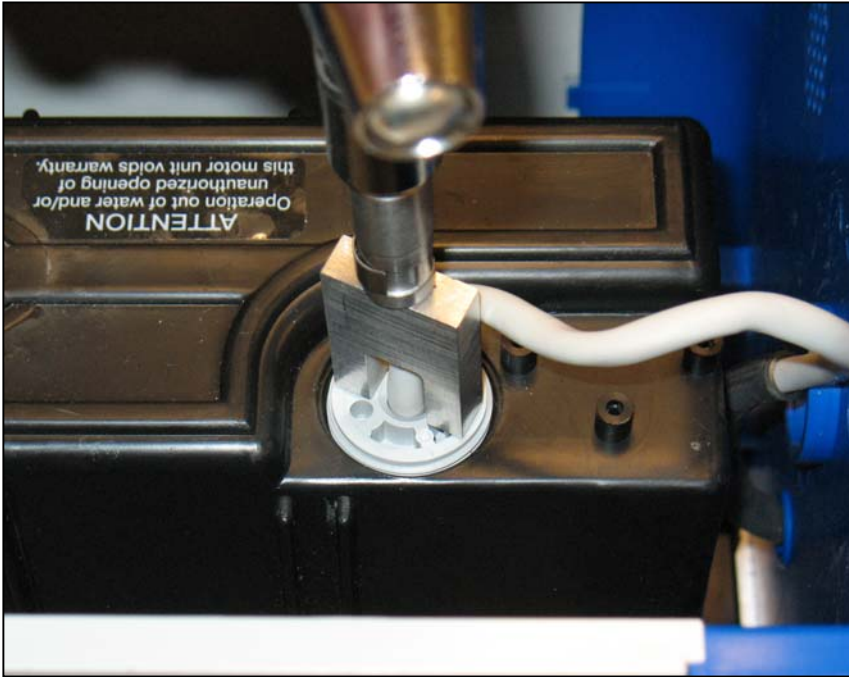
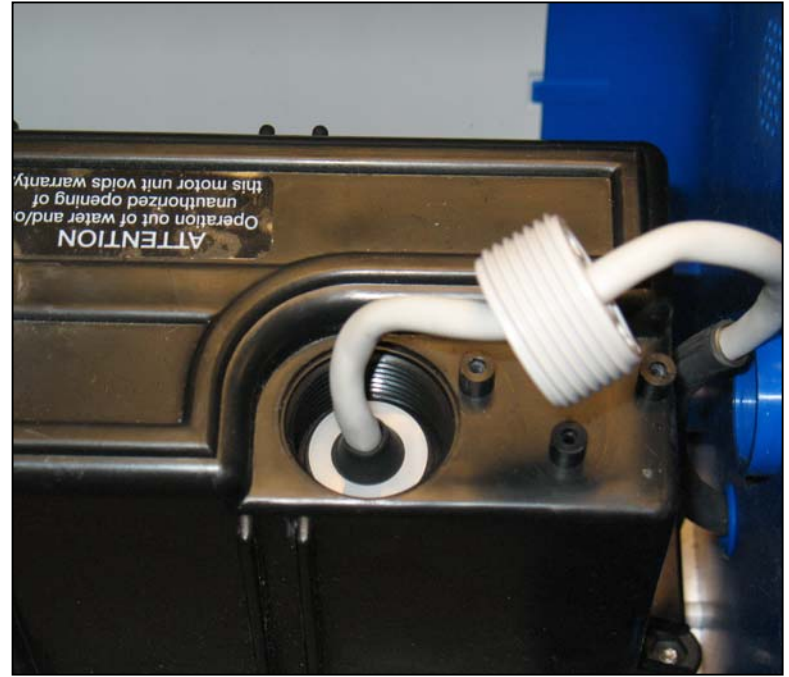

Plate removed showing strain relief system.

# Power Cord & Motor Box Removal



Use spanner wrench and Torque driver to remove threaded plug securing power cord into motor assembly. CCW removal.



Threaded plug removed

# Power Cord & Motor Box Removal

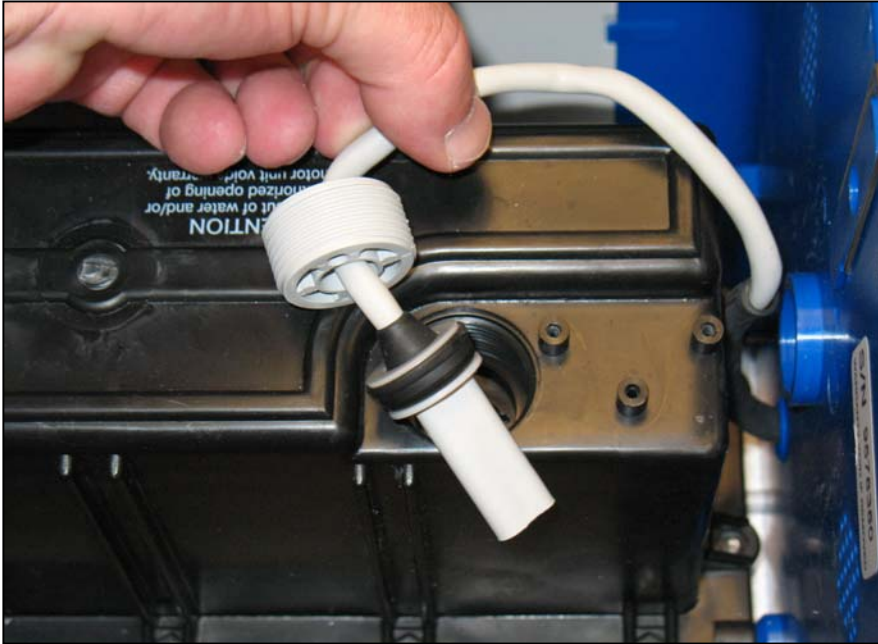

Gently pull on cord to disconnect and remove from motor.

Note: Any time seal is removed it is recommended to replace special rubber seal.

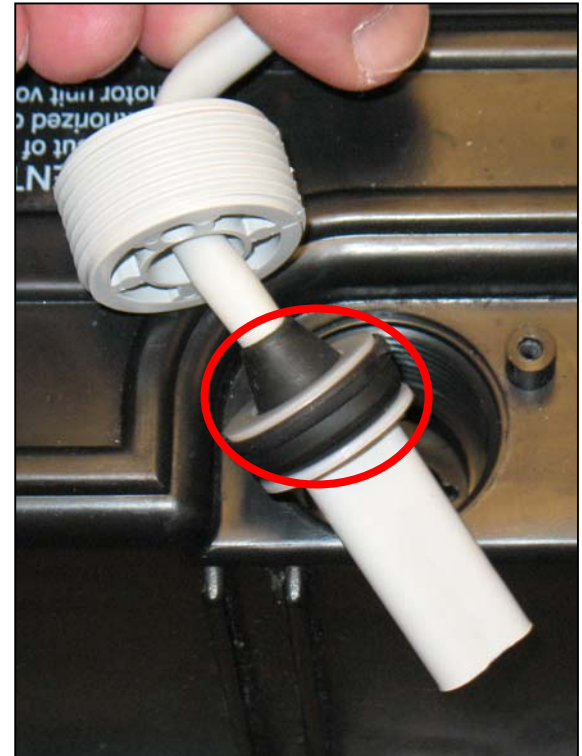

Note that plug has taper on bottom side to mate with rubber seal taper.



# Power Cord & Motor Box Removal

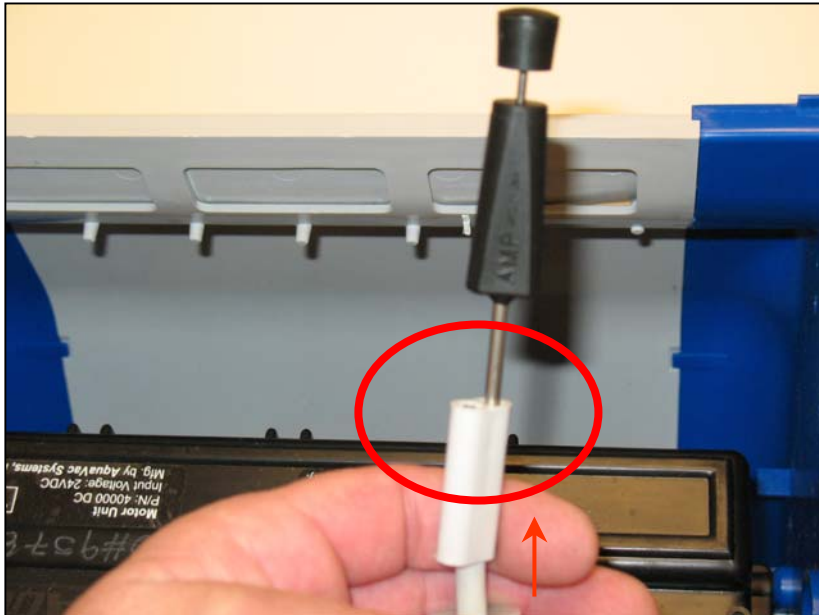

Carefully insert pin removal tool into power cord connector. Push wires up into connector as far as possible.

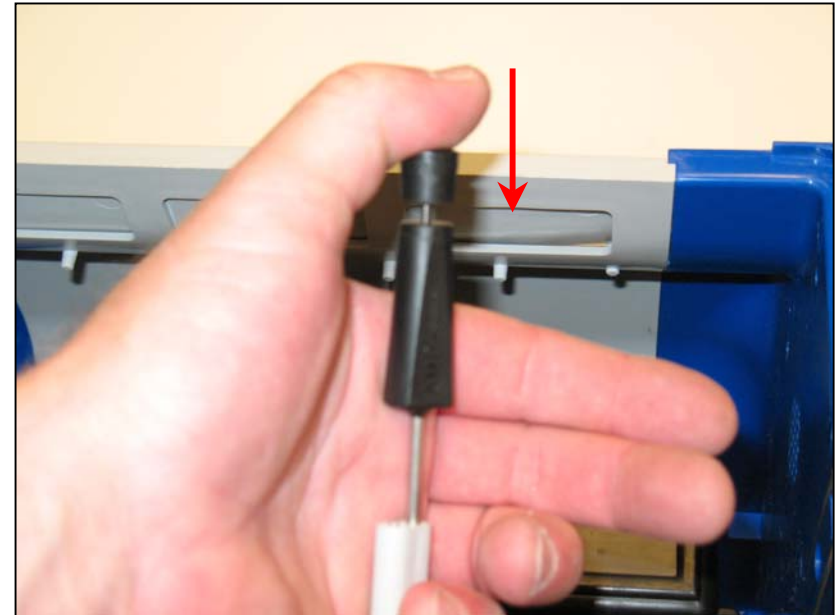

While holding connector firmly, depress button on pin removal tool to remove electrical connector pin from housing.

# Power Cord & Motor Box Removal



Power cord electrical pins removed from connector. Note that white wire goes on tab side of connector.

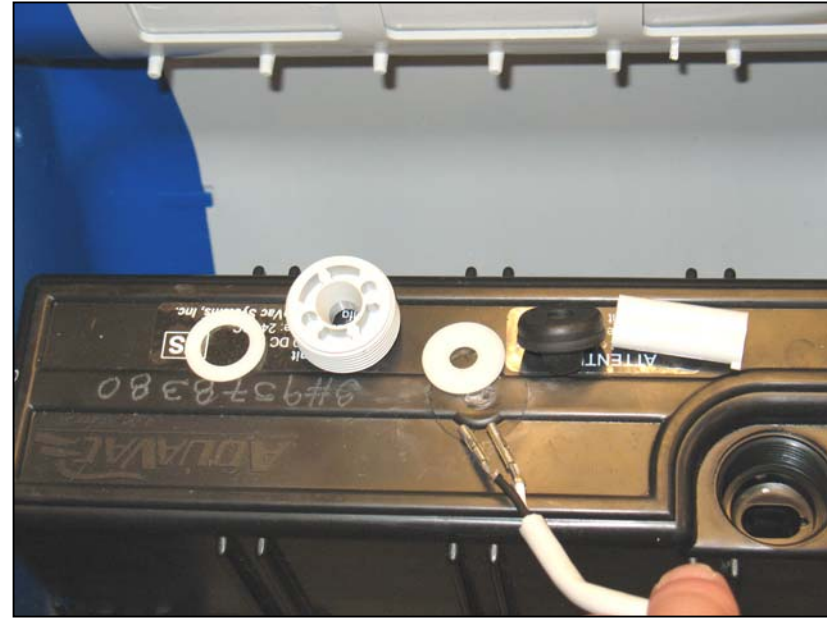

Connector, seals and washers removed.



# Power Cord & Motor Box Removal



Connector must be installed with tab on connector placed in mating hole of motor assembly. The white wire must be inserted on the tab side of the connector.

Use the Torque driver and spanner wrench to install and tighten the threaded plug. Tighten the threaded plug until you feel the Torque wrench click or slip.

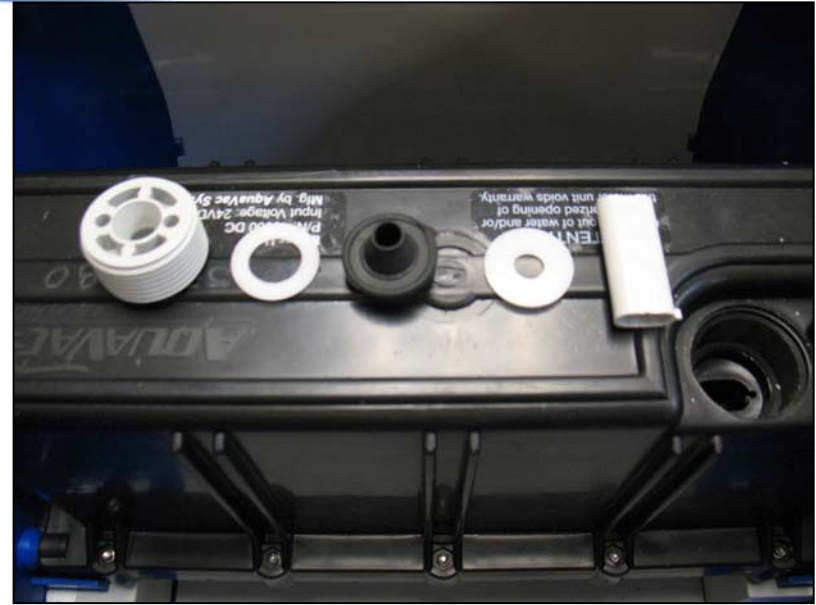

Note the order of the seals and washers. Remember to mate the taper of the seal and threaded plug.

# Power Cord & Motor Box Removal

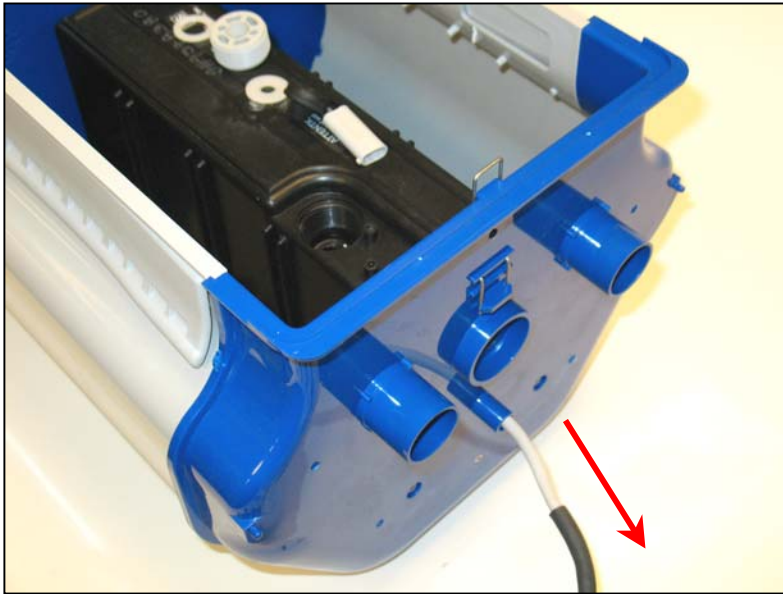

Gently route power cord out from unit.

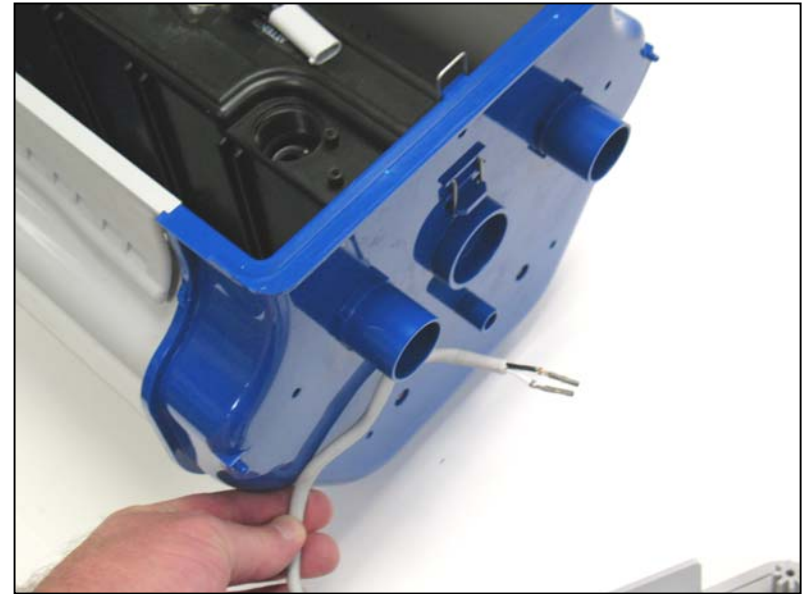

Power cord removed.

# Power Cord & Motor Box Removal

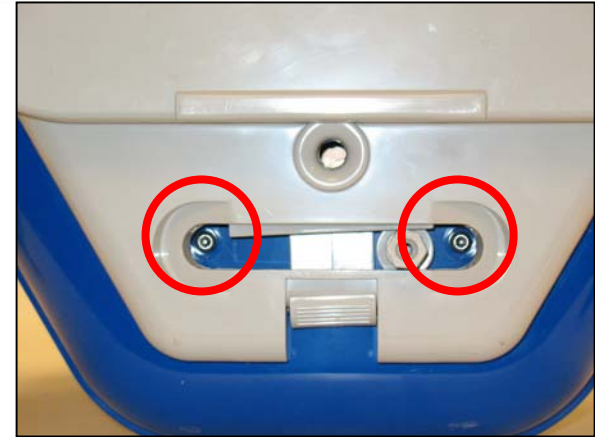
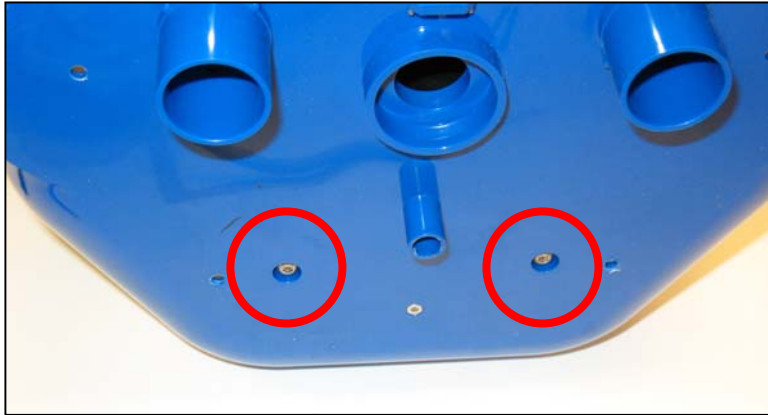

Location of motor screws when side cover is not removed. It is possible to remove motor assembly without removal of side cover. However, the 7 side cover screws must be loosened on the motor drive side.

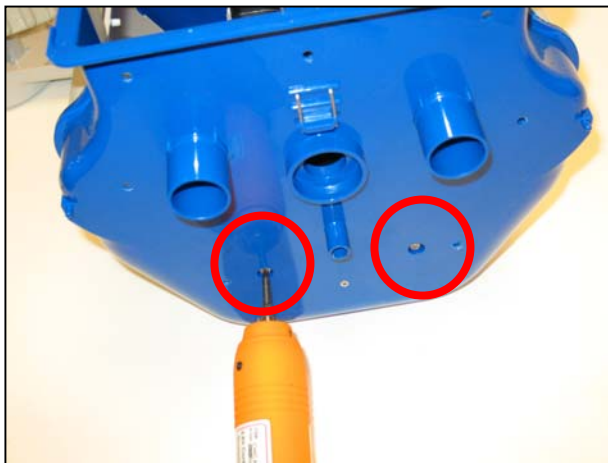

Remove 4 motor assembly screws 2 from each end.

# Power Cord & Motor Box Removal



When removing motor assembly without complete removal of side cover, gently separate motor output shaft from keyed drive gear using a screwdriver. The drive gear will remain in place. Be sure to remove all 4 motor securing screws, 2 each side and loosen side cover screws before attempting this.

# Power Cord & Motor Box Removal



Rotate motor slightly to remove drive output shaft from side of unit, then lift out motor assembly.

# Power Cord & Motor Box Removal

Output shaft key on motor, mates with drive gear.



Motor assembly removed.

Note: The motor assembly is a sealed unit and cannot be serviced, only replaced. It does not contain oil and is water cooled. The impeller can be replaced.



Impeller removal

# Wheel Tube Bearings

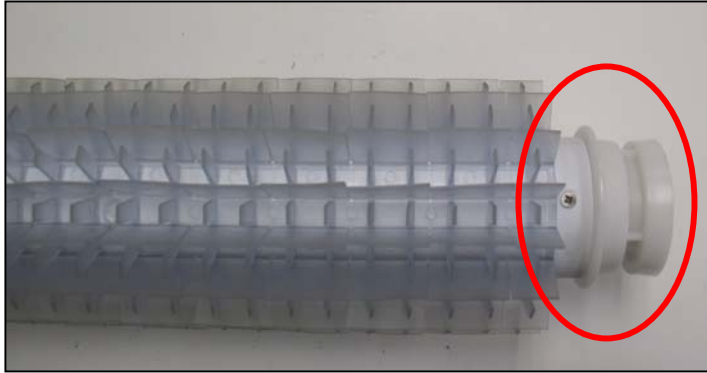

Remove wheel tube from machine

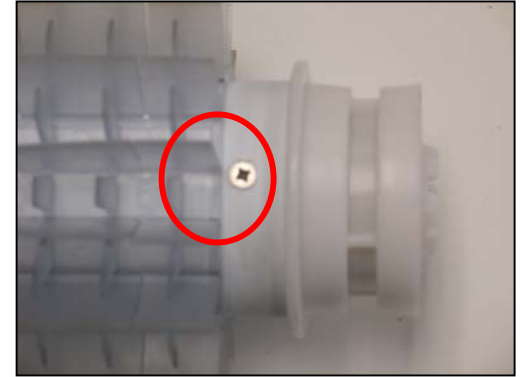

Remove 2 small  
phillips screws  
securing roller  
bearing to tube

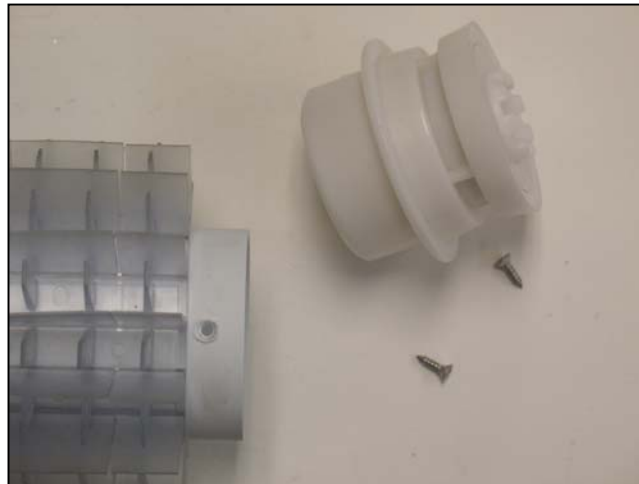

Bearing assembly will slip off tube

**Bearings should rotate smoothly  
and freely.**

# Wheel Tube Brush



Brush replacement can be done leaving the machine assembled or broken down. Unsnap the tabs, these run length wise of the brush.





# Wheel Tube Brush



Start in the center of the brush and put the post through the hole in the tab with the aid of a pair of needle nose pliers. Pull post slightly till taught then push down on tab until it locks into post. Spraying the post with soap and water sparingly will aid in assembly.

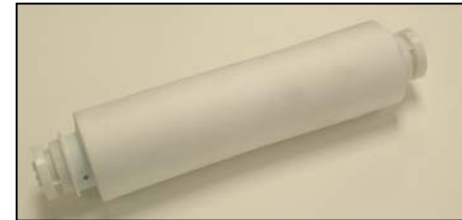

Foam roller

# Using The Scanner Tool

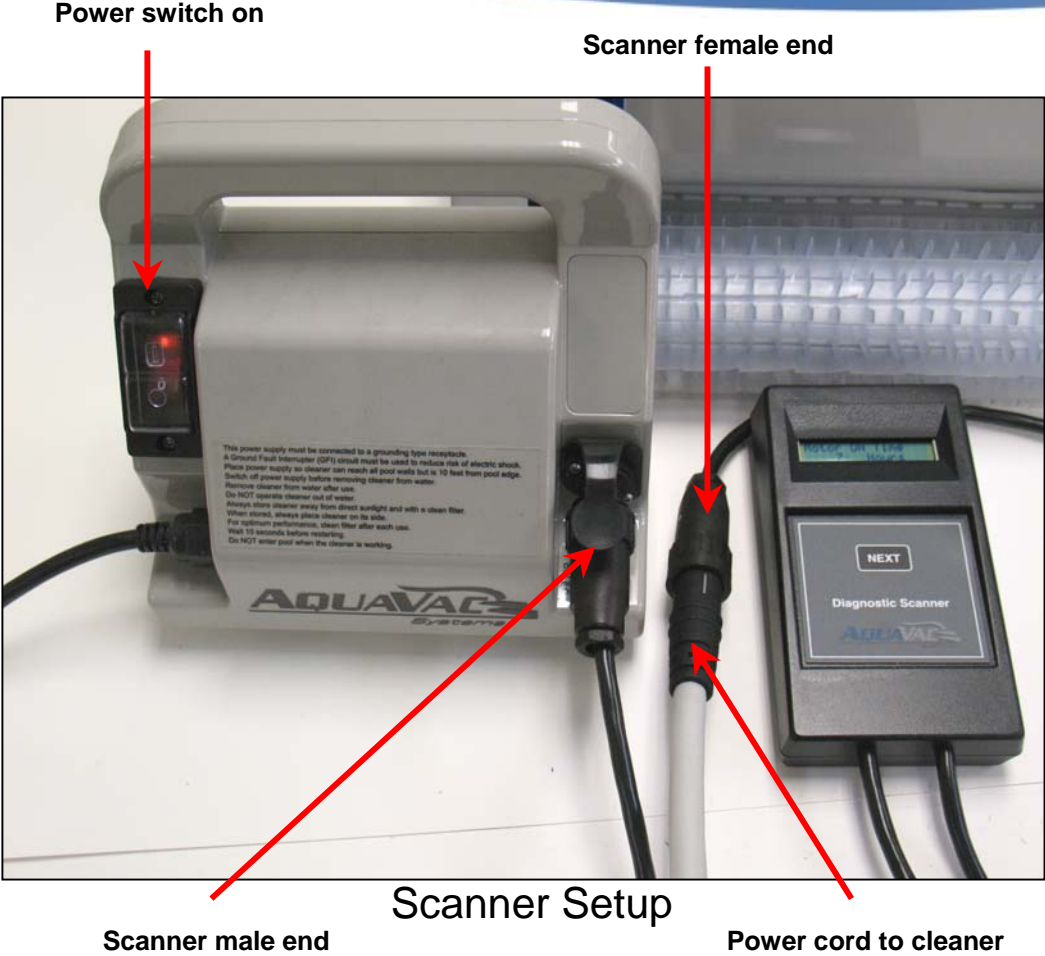

Startup Screen

# Using The Scanner Tool



Number of hours the unit has spent in the 4 hour cleaning cycle mode.



The combined total number of hours the unit has spent with the power switch on. Includes both hours accumulated in 'Motor On Time' and hours inactive after the cleaning cycle has been completed.



The total number of times the power switch was turned on to run the unit. This will not necessarily represent the complete cleaning cycles run.

# Using The Scanner Tool



The number of times the unit has realized a low load on the pump motor.



Number of times the pump motor has realized an over load condition. Unit will stop after 3-5 seconds in this condition.

## Out of Water Causes

1. Attempting to run the unit out of the water/pool.
2. Air trapped in the filter after placing the unit in the water.
3. Bench testing in manufacture or repair.
4. Machine climbing too high above the waterline.
5. Low voltage at power source.
6. Low voltage from use of an extension cord.
7. Worn or defective pump motor, drawing less than 1 amp at 24 volts.

## Pump Over Current Causes

1. Debris around the pump impeller. Remove impeller and inspect for hair or grass around pump shaft.
2. Defective pump motor. Motor should turn smoothly by hand with only a slight resistance from the shaft seals.

# Using The Scanner Tool



Number of times the drive motor has realized an over load condition. Unit will stop after 3-5 seconds in this condition.

## Drive Over Current Causes

1. Unit caught under a ladder
2. Debris caught in traction drive belt and or pulleys under side cover.
3. Riding or standing on unit during operation.
4. Defective wheel tube bearings or side cover idler bearings
5. Defective drive motor.



Number of times the water has contacted the sensor inside the motor box. Continuous contact will stop operation of the unit. Severe water damage will cause a 'Communication Failure' when hooked to the scanner.

# Testing Power Supply & Flotation Cord



Circuit failure between power supply and the PCB (printed circuit board) in the motor assembly box.

## Communication Failure Causes

1. Damaged power supply, check for 21-25 volts DC
2. Water inside power connection to motor box, check seal at motor box and for breaks in flotation hose
3. Damaged flotation cord, check for ohms reading of .4 to .8 ohms



Flotation cord test. Remove cord from motor box and check ohm's reading between each pin and wire end. .4 to .8 ohm's is acceptable.



Insert voltage probes in pin terminal 1 and 2 and turn on power supply to test.



DC voltage test on power supply  
21 to 25 volts dc is acceptable.  
The power supply is not repairable and must be replaced if defective.

# Troubleshooting

## ➤ Startup

- Machine will sequence between pump and drive motor for up to 1 minute.
- During this time the microprocessor is sampling motors for proper electrical load.

## ➤ Mapping Sequence

- At about 2 minutes the machine will begin mapping the immediate section of the pool.
- Wall climbing will be every other floor pass and the time on the wall climb will be random.
- The pattern is not permanently imbedded and will be reconfigured with each use of the cleaner.

## ➤ Wall Climbing

- Once in the cleaning cycle the machine will typically perform a wall climb every other floor pass and vary the amount of time on the wall.
- At random the machine will perform a free fall from the wall to aid in random navigation.
- The startup of each 4 hour cycle may require up to 30 minutes as the machine measures the pool configuration before climbing the walls completely to the water line.

# Troubleshooting

## ➤ In Process Mapping

- As the unit encounters large changes in pool configuration it will revert to the mapping process for a few passes to adjust itself to the change in shape.
- Mapping will take several passes and is undetectable from normal operation.

## ➤ Navigation

- The unit navigates itself primarily by running in a diagonal direction at the water line.
- This is the key to complete pool coverage.

## ➤ Shutdown

- The machine will shut down after 4 hours for the standard TigerShark.
- TigerShark QC will shutdown after 90 minutes if the Quick Clean LED is illuminated, or after 4 hours if “Full Cycle” is selected.
- The power supply will continue to supply low voltage to the unit and the diagnostic memory will continue to record hours until the power switch is turned off.



# Troubleshooting

## ➤ Will not climb walls

### **Filter Too Dirty to Allow Proper Machine Performance**

- Pool condition is unacceptable for cleaner use. Sweep walls, vacuum pool, balance chemicals and algaecide to an acceptable swimming condition. Resume use of TigerShark for pool maintenance as often as required.
- Increase frequency of TigerShark filter cleaning, especially during the initial use. Filter may have to be cleaned 30 minutes to 3 hours in the first few cycles until the pool is in an acceptable condition.
- Algae on pool walls. Brush walls and chemically treat for algae. Increase frequency of TigerShark use and filter maintenance.
- D.E. or sand filter leak. The primary pool filter may leak diatomaceous earth or fine sand that can overload the filter. Service and inspect the pool filter system, vacuum the pool and resume use of the TigerShark for pool maintenance.

# Troubleshooting

## ➤ Will not climb walls

### Pool design or configuration

- The pool bottom corner design may be too sharp. Some pool designs feature a sharp, 90 degree bottom corner. A guideline for the best machine performance is a corner radius similar in contour to a basketball. In a clean pool the machine symptom will be movement to the wall with repeated bumping and infrequent climbing, The PVC rollers can be replaced with foam rollers **only if a dirty pool condition is ruled out.**
- Clean vinyl or tile pool surface is too slick. Replace the PVC rollers with foam rollers **only if a dirty pool condition is ruled out.**

### Machine problem

- Broken impeller. Inspect and replace it if required. Inspect for tears that may allow objects to pass through and entangle or damage the impeller.
- Defective pump motor can be identified by a slow or non-rotating impeller. Replace the motor box assembly.

# Troubleshooting

## ➤ Will not climb walls

### **Confusion on normal operation**

- The startup of each 4 hour cycle may require up to 30 minutes as the machine measures the pool configuration before climbing the walls completely to the water line.
- During the 4 hour cycle the machine will randomly re-measure the pool configuration or release itself from the wall. The machine will not climb the walls during this 15-30 minute cycle.

## ➤ Climbs Too High, Falls off Wall at Waterline, Blows Air Bubbles Through the Exit Venturi

- Above average traction in a clean pool. Install the Restrictor Plate Kit RCX11206 in the venturi.
- Inspect bottom lid filter plate gasket and replace if torn or missing.
- Set handle position at an angle, machine should never operate with the handle in the center or straight position.
- Check water chemical balance.

# Troubleshooting

## ➤ Runs only a few seconds or minutes

- Make sure the machine is submerged in the water. An out of water detection within a few minutes will cause the machine to stop if not completely submerged.
- Check electrical source for proper voltage.
- If using an extension cord, test for proper voltage. An extension cord is not recommended.
- Check for missing or broken impeller blades.
- Check for pump impeller obstruction.
- Check pump impeller for hard rotation and pump motor binding.

## ➤ Cord twisting

- Alternate handle position with each use.
- Be sure machine is not getting caught on obstructions in the pool such as raised drains, in floor cleaning heads, toys, etc.

# Troubleshooting

## ➤ No movement but impeller turns

- Drive motor pin or drive motor is broken possible due to overload during use. To avoid repeat failure, follow-up with the customer for obstructions in the pool such as a ladder. The Scanner will display a Drive Over Current signal if the machine has been caught on an obstruction.
- Check for belt or roller obstruction
- Check for broken impeller
- Check for missing roller tube bearing screws, 2 per side.

## ➤ No movement and no pump discharge

- Check with the scanner for communication failure, see scanner section to diagnose.
- Check for impeller obstruction.
- Check for broken blades.
- Check electrical source for proper voltage range of 115-125v, including extension cord if used.

# Troubleshooting

## ➤ Debris falls from unit when removed from pool

- Filter overload, increase frequency of filter cleaning.
- Large debris blocking intake. Remove large debris from pool before using machine.
- Drain flaps out of place on bottom lid. Snap flaps back into place. Avoid dropping or throwing machine into the pool.

# Service Tools

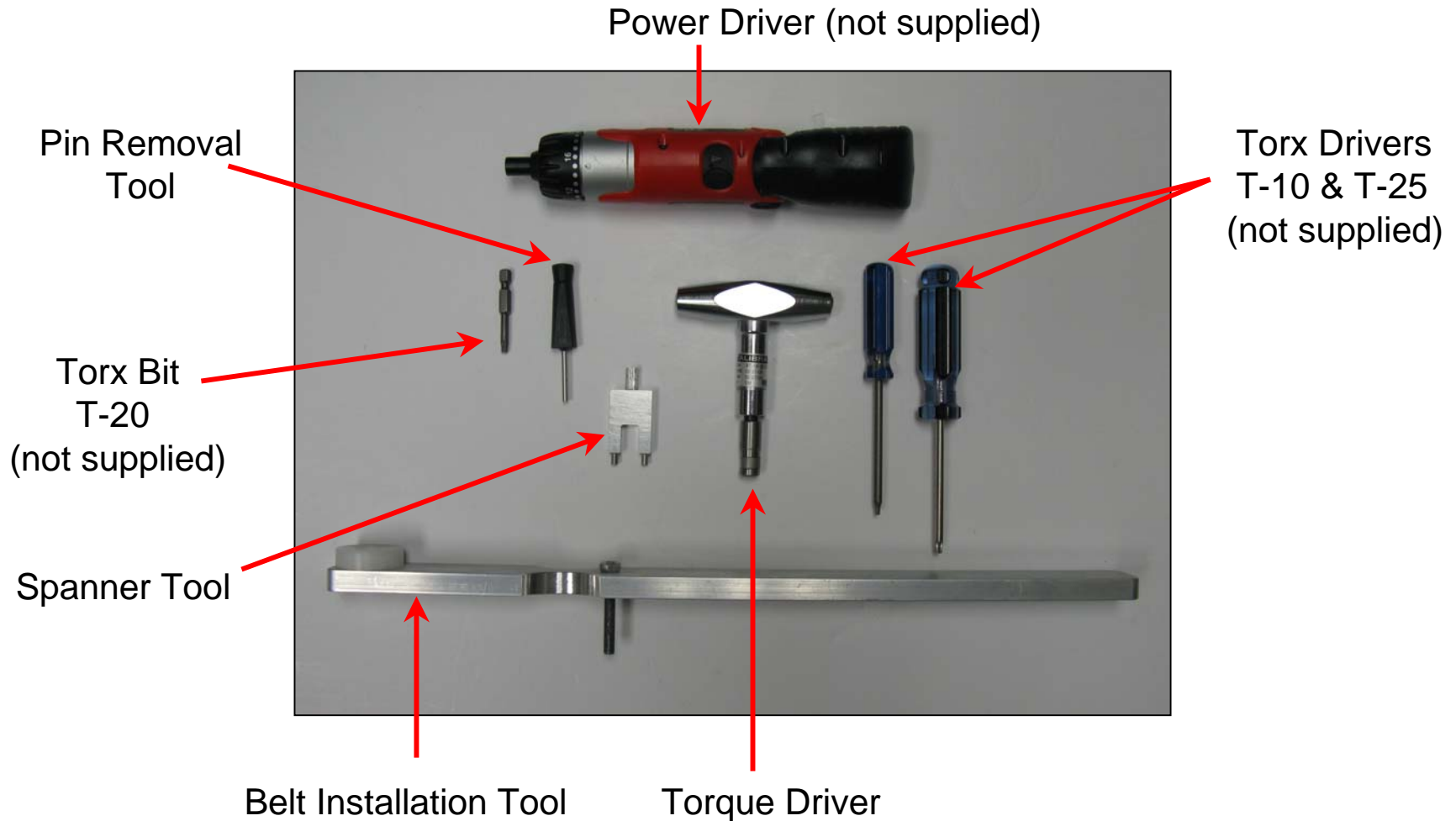

# Power Supply

On/Off Switch - Lighted



Installation  
and Care  
Instructions

Power Cord

Flotation Power Cord Connector



# Filter Removal

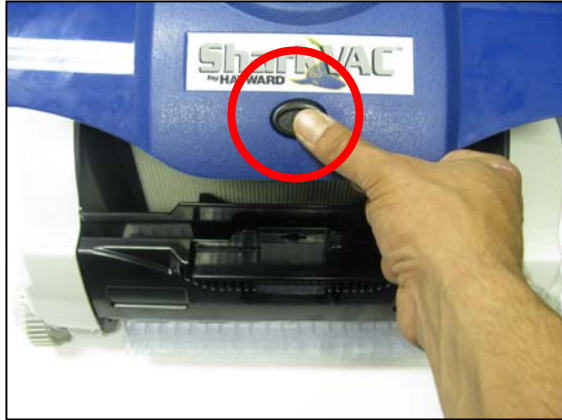

Press Dome Button to lift Dome for filter removal.



Lift to remove Filter Bucket Housing



Filter cartridge removed



Filter Bucket Housing

# Filter Removal



Open filter doors by pushing the tabs toward the outside and then pulling up.



Lift filter cartridges out.



**Note:** Elements can be cleaned by gently spraying with a garden hose. Be careful not to use high pressure or this may damage the element.



Spring cleanup filter elements. For temporary use in heavy spring cleaning.

# Filter Replacement

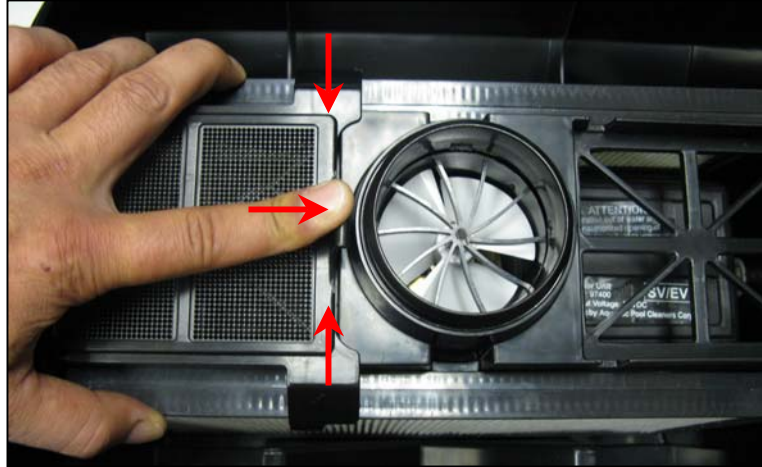

Hold both cartridges toward center. Push down cover and press tab towards fan to lock cartridges in place.



Make sure cover snaps in place.

# Wheel and Tire Removal



Remove wheel cap to access screw holding wheel on axel.



Unscrew T25 screw



Remove wheel from axel. Notice how wheel and axel mate.

# Side Cover Removal

Power cord    Motor assembly    Impeller    Motor output shaft.  
Drive end.

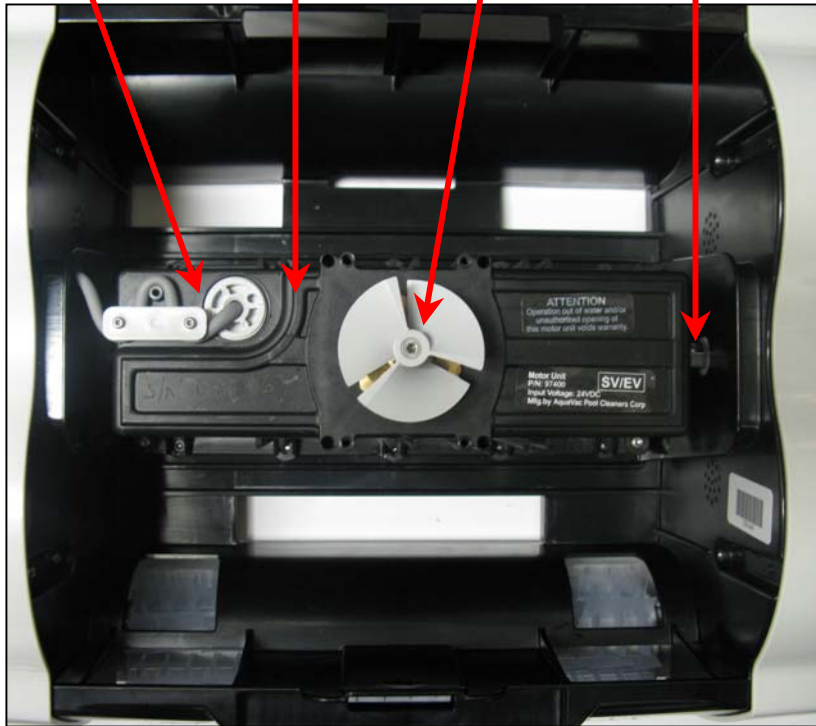

Top view with bottom lid and filter assembly removed.

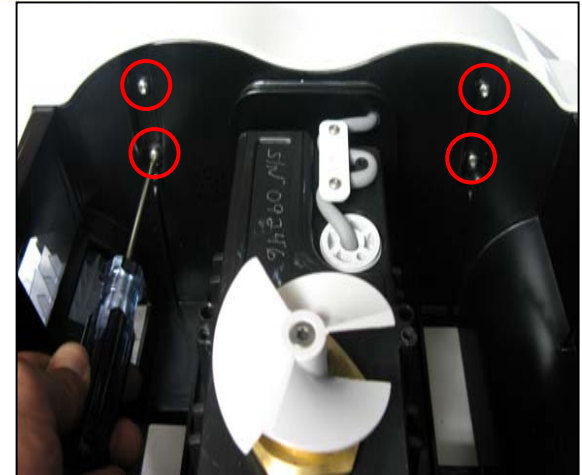

4 T20 screws each side to remove for side plate removal.



Drive side view with cover removed.

# Drive Track & Idler Pulley Removal

Drive Side

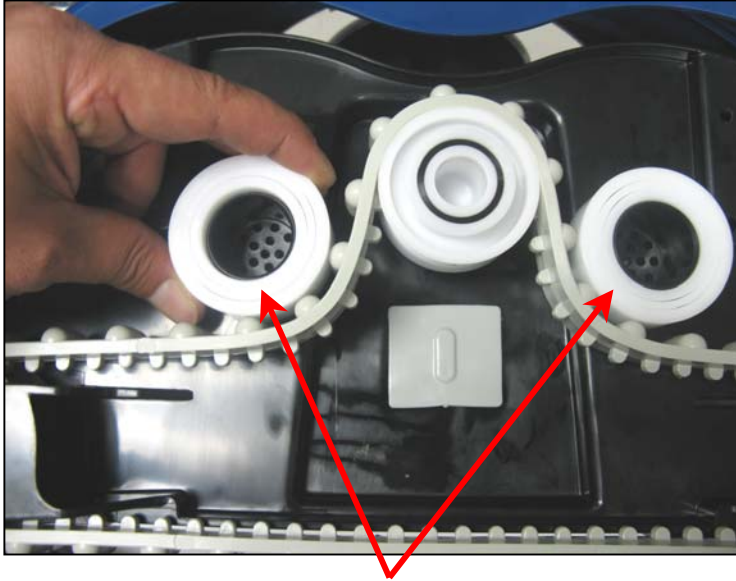

Track idler pulleys



Check for missing/broken drive cogs on inner loop of belt and also for cracks in belt.

Bearings should rotate smoothly and freely.



Note that flange faces inward.

# Main Drive Pulley Removal

Note drive 'key' in pulley and how it mates to the output shaft drive pin of the motor.

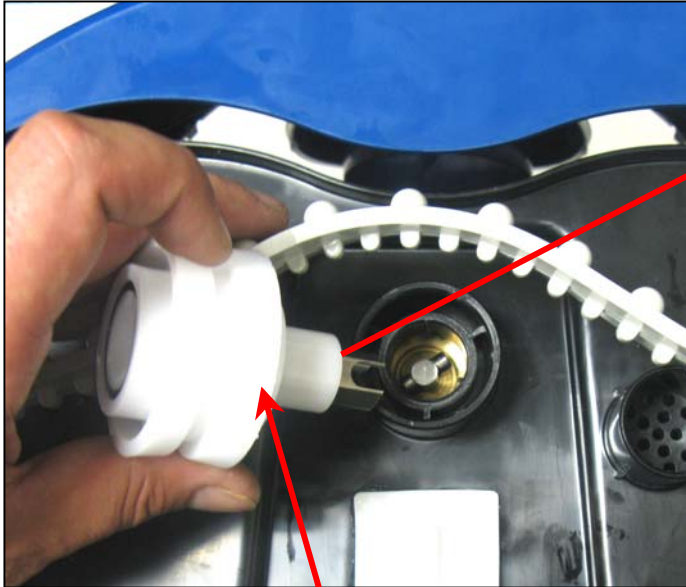

Main drive pulley, motor output side only

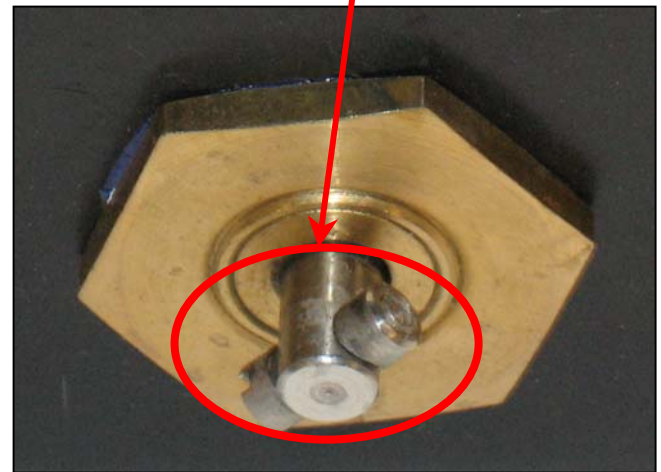
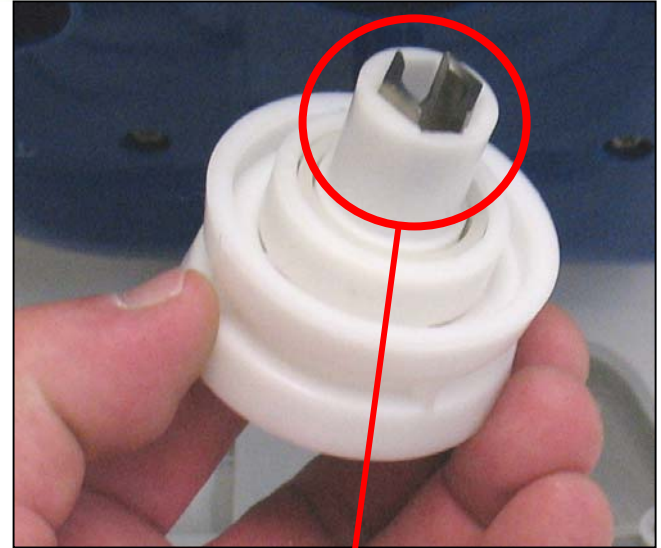

# Wheel Tube Removal

## Rear Tube

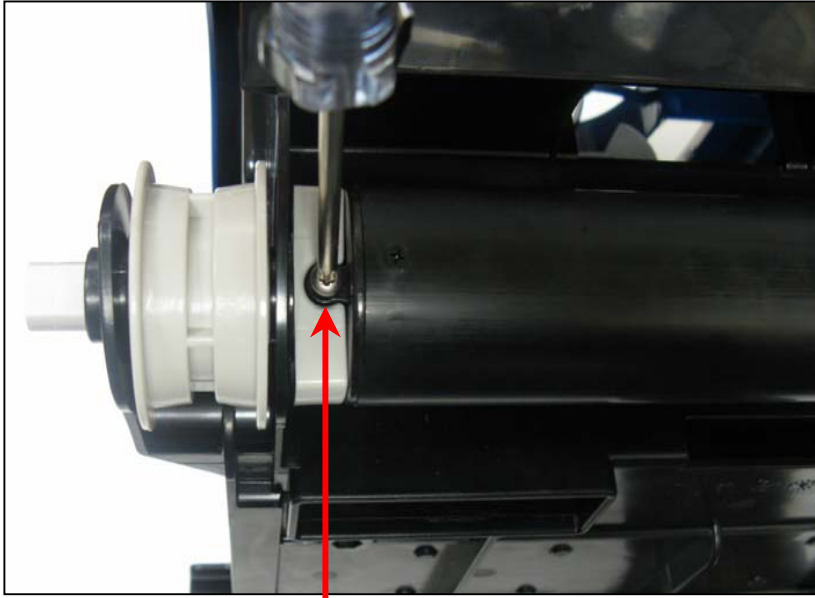

Unscrew T20 screws from each side of roller.

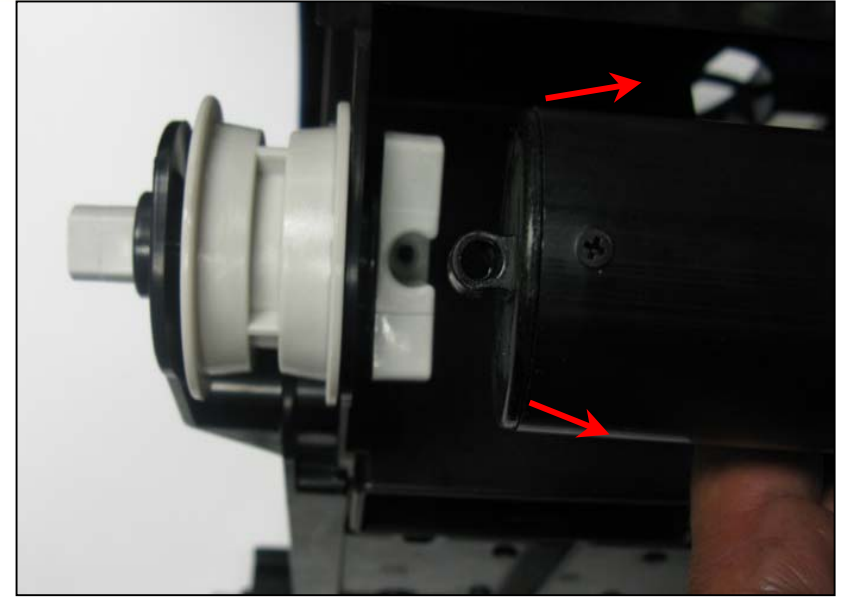

Carefully pull wheel tube away from wheel axels.

## Front Tube

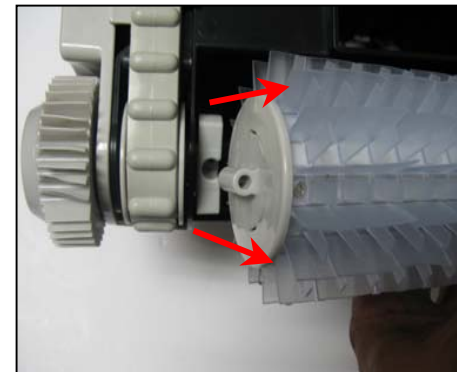



# Wheel Tube Brush

## Removal

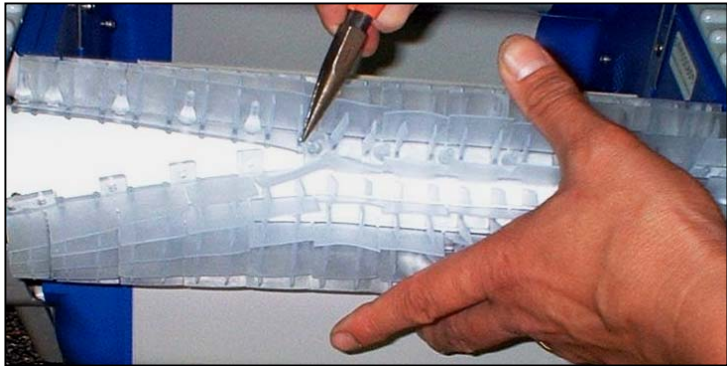

Brush replacement can be done leaving the machine assembled or broken down. Unsnap the tabs that run length wise of the brush.



## Replacement

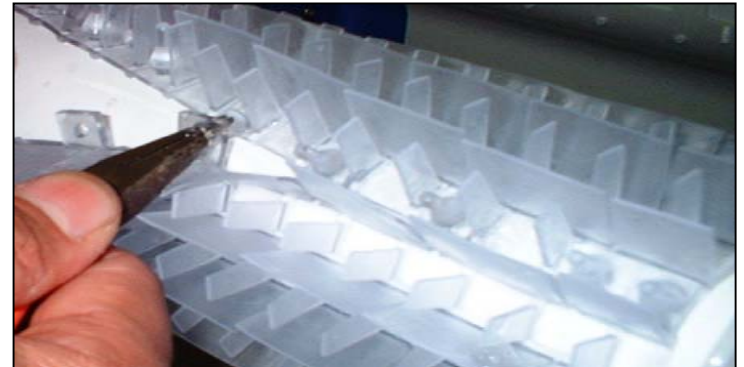

Start in the center of the brush and put the post through the hole in the tab with the aid of a pair of needle nose pliers. Pull post slightly till taugt then push down on tab until it locks into post. Spraying the post with soap and water sparingly will aid in assembly.

# Power Cord Removal

Remove strain relief cover plate.

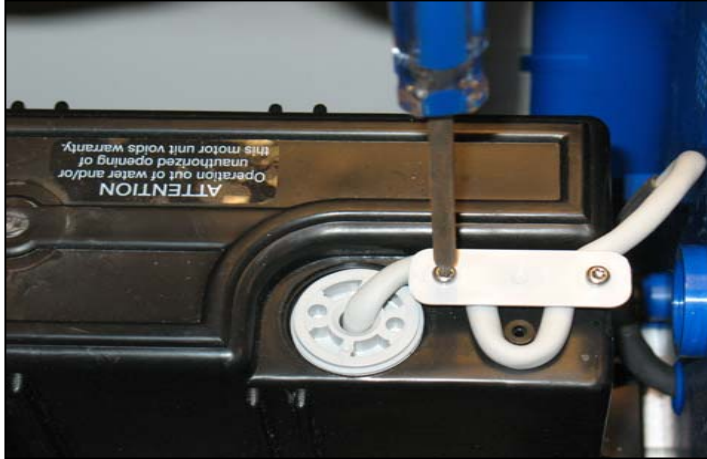
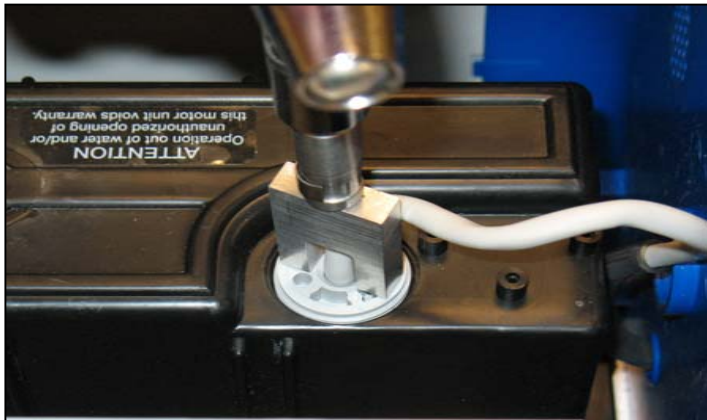

Plate removed showing strain relief system.



Use spanner wrench and Torque driver to remove threaded plug.



Threaded plug removed



# Power Cord Removal



Gently pull on cord to disconnect and remove from motor.



Note that plug has taper on bottom side to mate with rubber seal taper.

Note: Any time seal is removed it is recommended to replace special rubber seal.



# Power Cord Removal

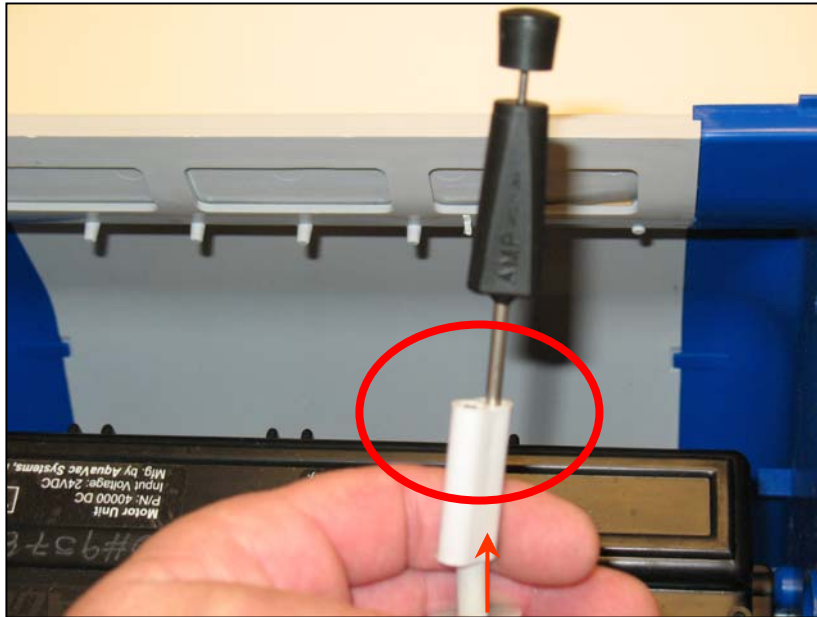

Push wires up into connector as far as possible. Carefully insert pin removal tool into power cord connector.

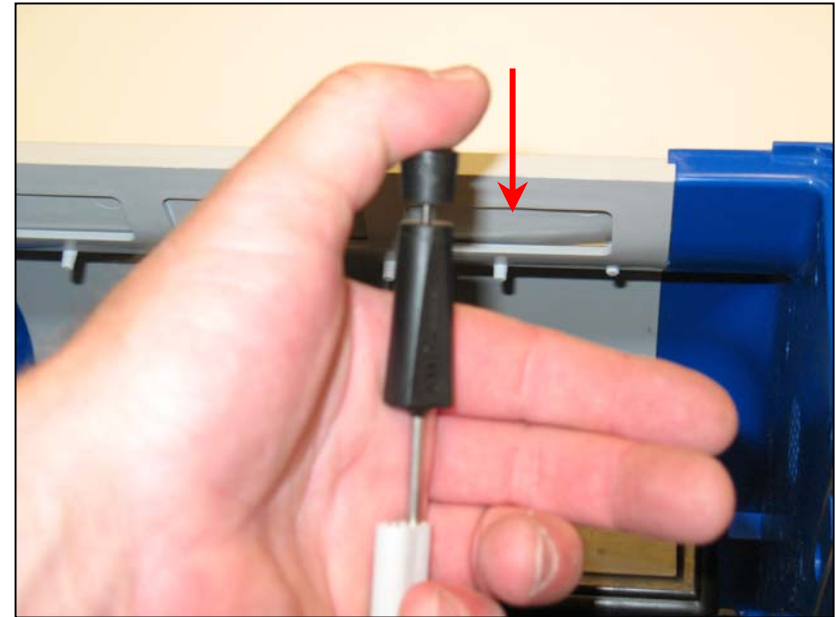

While holding connector firmly, depress button on pin removal tool to remove electrical connector pin from housing.

# Power Cord Removal

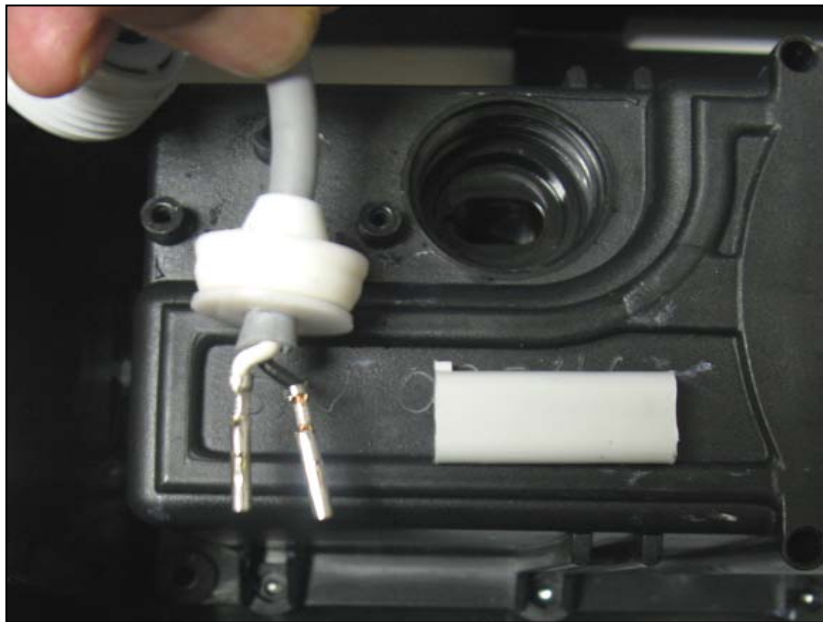

Power cord electrical pins removed from connector. Note that white wire goes on tab side of connector.

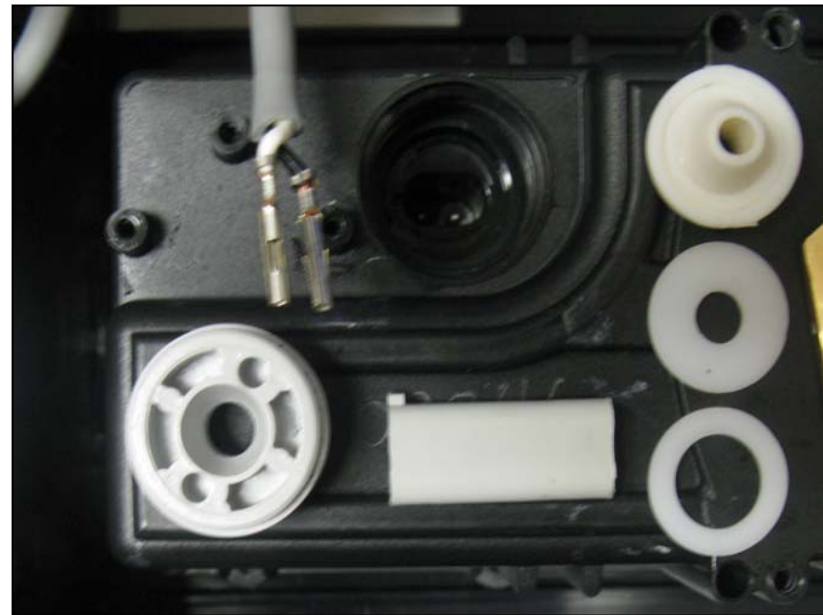

Connector, seals and washers removed.

# Power Cord Removal



Connector must be installed with tab on connector placed in mating hole of motor assembly. The white wire must be inserted on the tab side of the connector.

Use the Torque driver and spanner wrench to install and tighten the threaded plug. Tighten the threaded plug until you feel the Torque wrench click or slip.

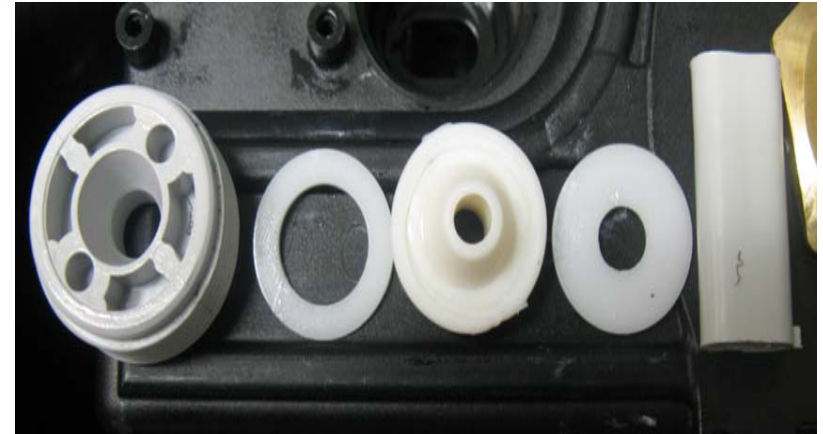

Note the order of the seals and washers. Remember to mate the taper of the seal and threaded plug.

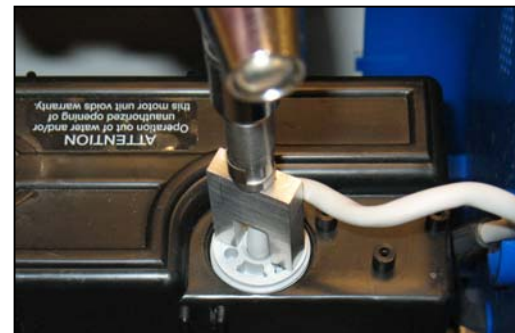

# Power Cord Removal



Gently route power cord out from unit.



Power cord removed.

# Motor Box Removal



Remove 4 T20 screws securing motor to base.



When removing motor assembly without complete removal of side cover, gently separate motor output shaft from keyed drive gear using a screwdriver. The drive gear will remain in place. Be sure to remove all 4 motor securing screws.



# Motor Box Removal

Rotate motor slightly to remove drive output shaft from side of unit, then lift out motor assembly.



**Note:** The motor assembly is a sealed unit and cannot be serviced, only replaced. It does not contain oil and is water cooled. The impeller can be replaced.

Output shaft key on motor, mates with drive gear.



Impeller removal

# Testing Power Supply & Flotation Cord

## Communication Failure Causes

1. Damaged power supply, check for 21-25 volts DC
2. Water inside power connection to motor box, check seal at motor box and for breaks in flotation hose
3. Damaged flotation cord, check for ohms reading of .4 to .8 ohms

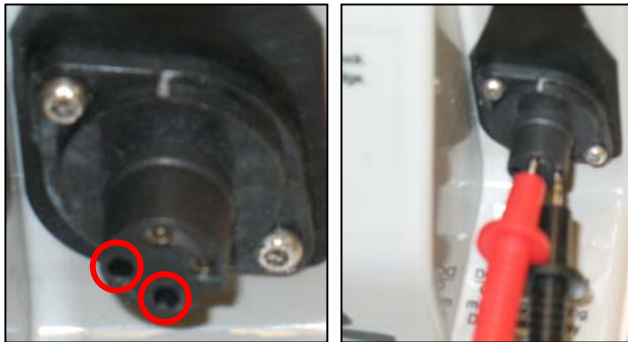

Insert voltage probes in pin terminal 1 and 2 and turn on power supply to test.



Flotation cord test. Remove cord from motor box and check ohm's reading between each pin and wire end. .4 to .8 ohm's is acceptable.



DC voltage test on power supply  
21 to 25 volts dc is acceptable. The power supply is not repairable and must be replaced if defective.

# Troubleshooting

## ➤ Startup

- Machine will sequence between pump and drive motor for up to 1 minute.
- During this time the microprocessor is sampling motors for proper electrical load.

## ➤ Mapping Sequence

- At about 2 minutes the machine will begin mapping the immediate section of the pool.
- The pattern is not permanently imbedded and will be reconfigured with each use of the cleaner.

## ➤ In Process Mapping

- As the unit encounters large changes in pool configuration it will revert to the mapping process for a few passes to adjust itself to the change in shape.
- Mapping will take several passes and is undetectable from normal operation.

# Troubleshooting

## ➤ Navigation

- The unit navigates itself primarily by running in a diagonal direction at the water line.
- This is the key to complete pool coverage.

## ➤ Shutdown

- The machine will shut down after 2 hours.
- The power supply will continue to supply low voltage to the unit and the diagnostic memory will continue to record hours until the power switch is turned off.

## ➤ Cleaner flips upside down and continues to run

- The machine should correct itself and flip upright.
- Check for water in handle. Replace if necessary.
- Replace motor.

# Troubleshooting

## ➤ Runs only a few seconds or minutes

- Make sure the machine is submerged in the water. An out of water detection within a few minutes will cause the machine to stop if not completely submerged.
- Check electrical source for proper voltage.
- If using an extension cord, test for proper voltage. An extension cord is not recommended.
- Check for missing or broken impeller blades.
- Check for pump impeller obstruction.
- Check pump impeller for hard rotation and pump motor binding.

## ➤ Cord twisting

- Be sure machine is not getting caught on obstructions in the pool such as raised drains, in floor cleaning heads, toys, etc.

# Troubleshooting

## ➤ No movement but impeller turns

- Drive motor pin or drive motor is broken possible due to overload during use. To avoid repeat failure, follow-up with the customer for obstructions in the pool such as a ladder.
- Check for belt or roller obstruction
- Check for broken impeller
- Check for missing roller tube bearing screws, 2 per side.

## ➤ No movement and no pump discharge

- Check for impeller obstruction.
- Check for broken blades.
- Check electrical source for proper voltage range of 115-125v, including extension cord if used.

# Troubleshooting

## ➤ Debris falls from unit when removed from pool

- Filter overload, increase frequency of filter cleaning.
- Large debris blocking intake. Remove large debris from pool before using machine.
- Drain flaps out of place on bottom lid. Snap flaps back into place. Avoid dropping or throwing machine into the pool.