



XT-Spyke | Install Instructions For:

XT-Spyke

Box Contents for Surface Mounting

- 1 - XT-Spyke
- 1 - Surface mount bracket
- 4 - Mounting Bolts

Box Contents for Pole Mounting

- 1 - XT-Spyke
- 1 - Pole-mount spindle
- 4 - Mounting Bolts

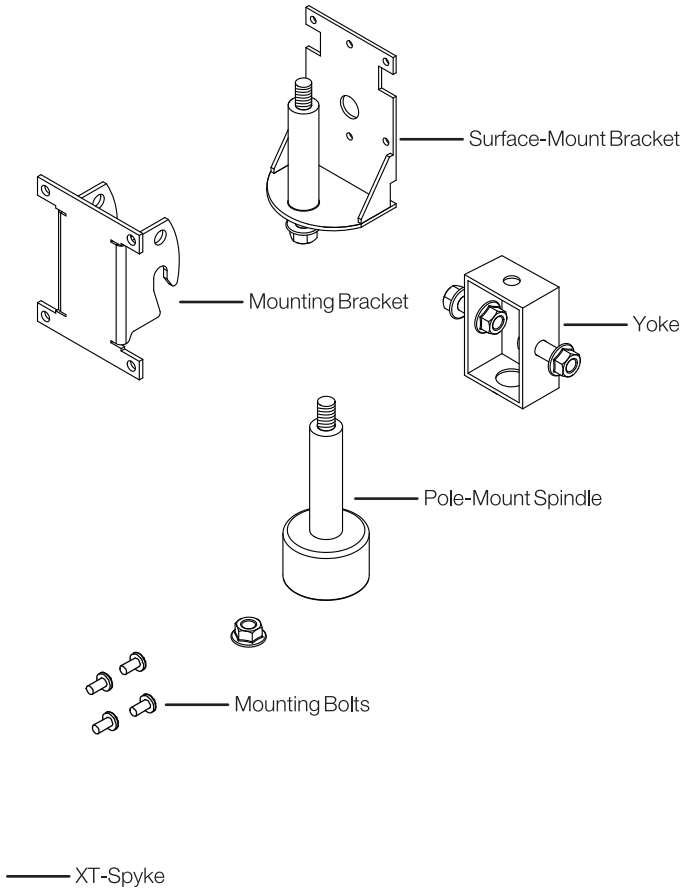
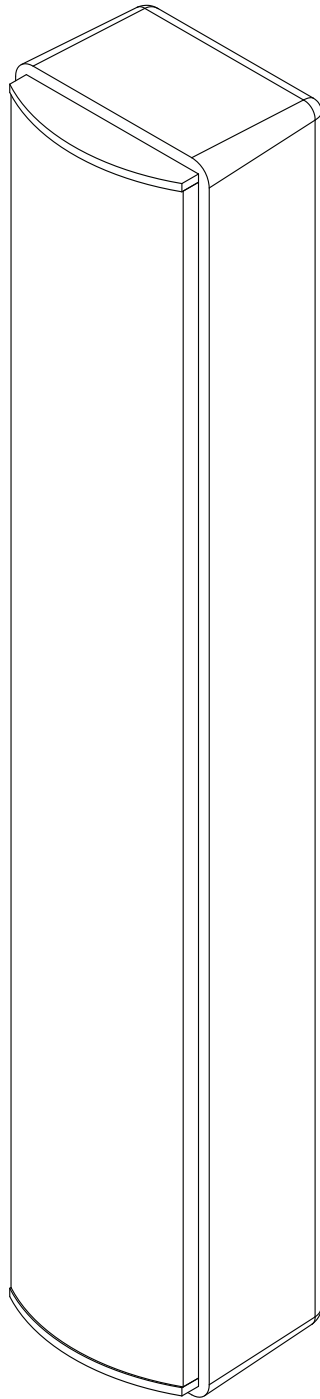

1.913.663.5600 | 855.663.5600 | www.soundtube.com

©2016 SoundTube Entertainment, Inc. All rights reserved. PN INS-XT-Spyke Rev 01.25.2016

Warning

SoundTube products must be installed by a professional audio installer/contractor. For safety and for optimum audio performance, installer must follow all directions issued by SoundTube Entertainment.

Warning

Do not spec or install speaker near support beam, ventilation duct or other structure that may interfere with speaker function or dispersion.

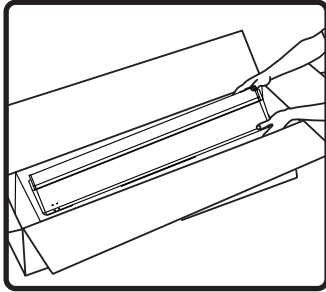

1. Unpack speaker.

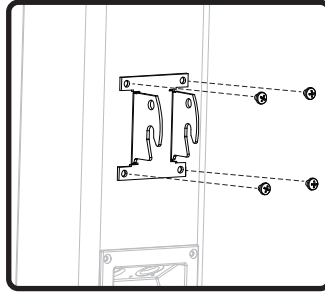

2. Using supplied bolts, attach included mounting bracket to rear of speaker either on the top or bottom of the cabinet depending on the application. **WARNING: Do not exceed 100 in-lbs when installing bolts in threaded inserts.**

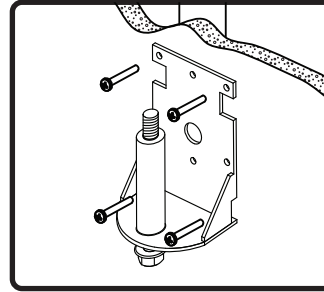

3. Attach surface-mount bracket to desired surface (mounting screws not included). Choose a secure mounting surface with sufficient strength to reliably hold the speaker.

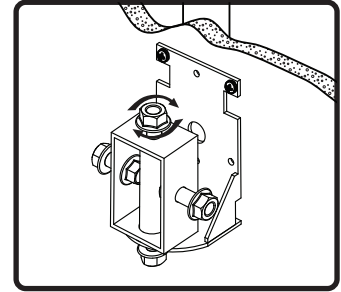

4. Slide yoke over spindle on surface-mount bracket and loosely secure nut on top.

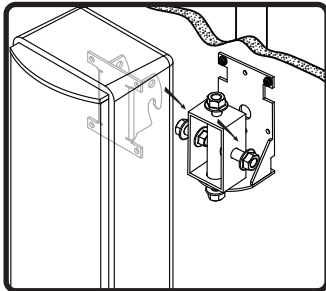

5. Slide speaker with mounting bracket attached onto the Yoke assembly and loosely secure nuts.

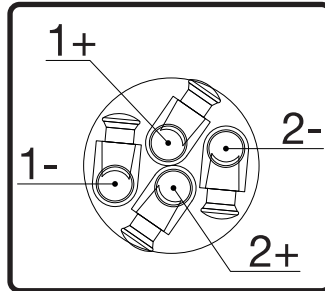

6. Wiring the SpeakOn cable (not included): Wire positive speaker input (+) to SpeakOn +1 terminal and negative speaker input (-) to SpeakOn -1 terminal. Use SpeakOn 2 terminals (+ & -) for daisy-chaining additional speakers.

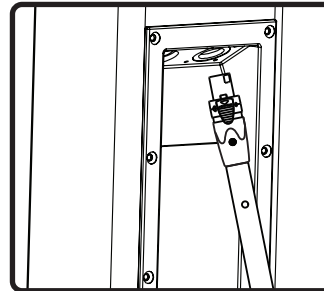

7. Insert the end of the SpeakOn cable into the SpeakOn input connector, and twist to lock.

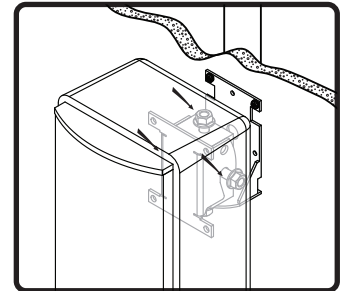

8. Position speaker in desired orientation and tighten all 3 nuts to secure.

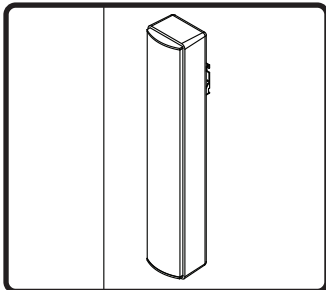

9. Done!

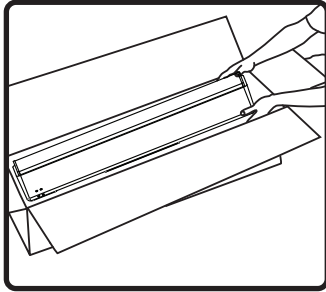

1. Unpack speaker.

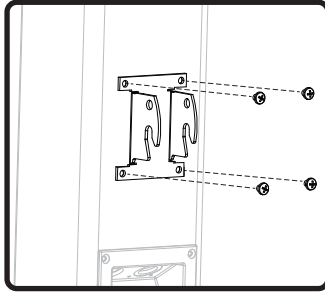

2. Using supplied bolts, attach included mounting bracket to rear of speaker either on the top or bottom of the cabinet depending on the application.
WARNING: Do not exceed 100 in-lbs when installing bolts in threaded inserts.

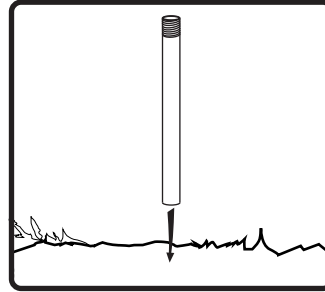

3. Drive 1-1/4" NP pipe(not included) into desired ground location and secure with the method of your choosing.

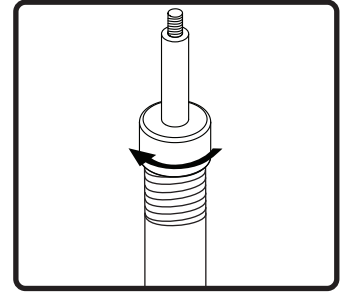

4. Thread pole-mount spindle onto 1-1/4" NP pipe and tighten until it is secure.

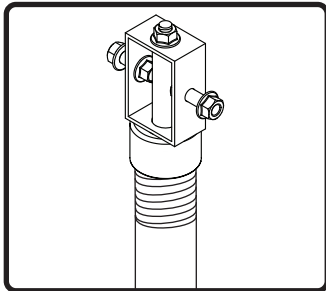

5. Slide Yoke over spindle on and loosely secure nut on top.

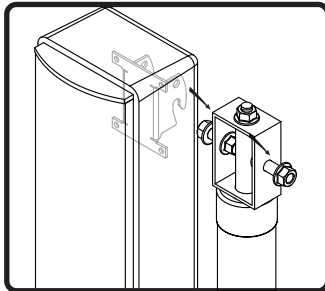

6. Slide speaker with mounting bracket attached onto the Yoke assembly and loosely secure nuts.

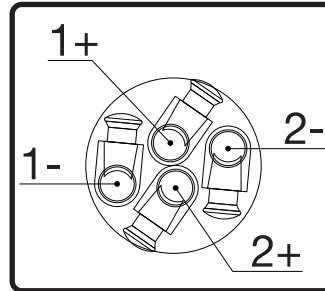

7. Wiring the SpeakOn cable (not included): Wire positive speaker input (+) to SpeakOn +1 terminal and negative speaker input (-) to SpeakOn -1 terminal. Use SpeakOn 2 terminals (+ & -) for daisy-chaining additional speakers.

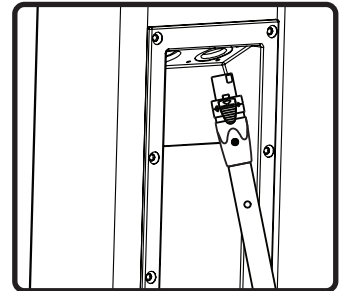

8. Insert the end of the SpeakOn cable into the SpeakOn input connector, and twist to lock.

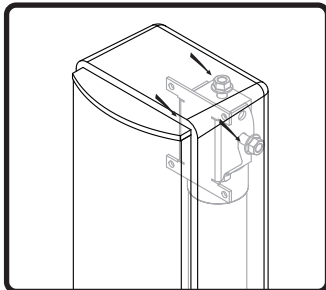

9. Position speaker in desired orientation and tighten all 3 nuts to secure.

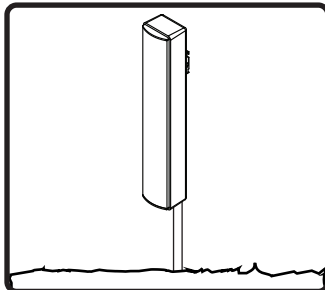

10. Done!



XT-Spyke

Install Instructions For:
XT-Spyke
