

EMERSON QUIET KOOL®

# OWNER'S MANUAL

Electronic Window Air Conditioner

MODEL:

6,000 BTU

8,000 BTU

10,000 BTU

12,000 BTU

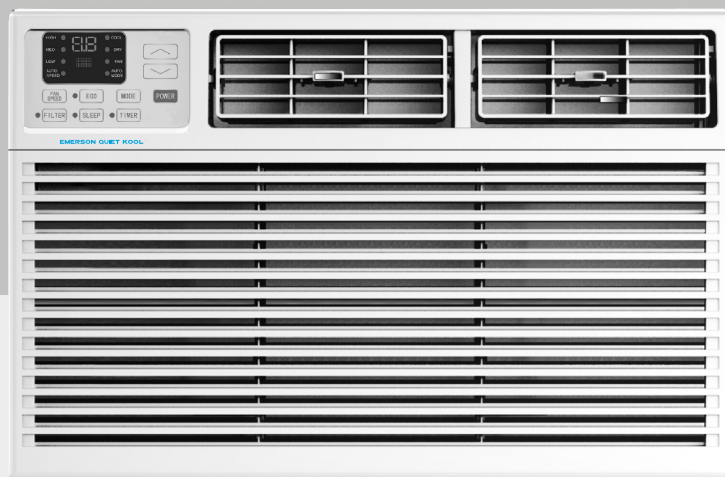

Thank you very much for purchasing our air conditioner. Please read this owner's manual carefully before using your air conditioner.



## THANK YOU!

Congratulations on your purchase and welcome to the EMERSON QUIET KOOL® Family. Your new EMERSON QUIET KOOL® Air Conditioner combines high-efficiency operation with portable convenience.

By following the operating and care instructions in this manual, your air conditioner will provide you with many years of reliable service.

---

# INTRODUCTION

IMPORTANT SAFETY INSTRUCTION .....	1
ELECTRICAL REQUIREMENTS .....	2
PACKING LIST .....	3
INSTALLATION & ASSEMBLY INSTRUCTIONS .....	4
USING YOUR AIR CONDITIONER .....	9
OPERATING YOUR AIR CONDITIONER .....	11
CARE AND CLEANING .....	12
TROUBLESHOOTING .....	13

## IMPORTANT SAFETY INSTRUCTIONS

Before installing and using your air conditioner, please read this owner's manual carefully. Store this manual in a safe place for future reference. Your safety and the safety of others is very important to us. Please pay attention to all safety messages outlined in this owner's manual.

**WARNING:** To reduce the risk of fire, electrical shock or injury when using your air conditioner, follow the basic precautions below:

- Plug into a grounded 3 prong outlet.
- Do not remove the ground prong.
- Do not use a plug adapter.
- Do not use an extension cord.
- Unplug the air conditioner before servicing.
- Use two or more people to move and install the air conditioner.



This is a safety alert symbol.

This symbol alerts you to potential hazards that can harm you or others or even cause death.

All safety messages will directly follow the safety alert symbol and/or the words "DANGER" or "WARNING".

**⚠ DANGER**

**⚠ WARNING**

Failure to immediately follow these instructions may cause serious injury or even death.

All Safety messages alert you of potential hazards, how to reduce the chance of injury, and what can happen if instructions are not followed correctly.

# ELECTRICAL REQUIREMENTS

## ⚠ WARNING



### Electrical Shock Hazard

Plug into a grounded 3 prong outlet.  
Do not remove the ground prong.  
Do not use an adapter.  
Do not use an extension cord.  
Failure to follow these instructions can result in death, fire, or electrical shock.

The electrical ratings for your air conditioner are listed on the model and serial number label located on the front left side of the unit (when facing the front).

Specific electrical requirements are listed in the chart below. Follow the requirements below for the type of plug on the power supply cord.

### Wiring Requirements

- 115 volt (103 min.—127 max)
- (6K-8K) 0-8 amps  
(10K-12K) 0-12 amps
- (6K-8K) 10-amp time-delay fuse or circuit breaker  
(10K-12K) 15-amp time-delay fuse or circuit breaker
- Use on single outlet circuit only

### Power Supply Cord

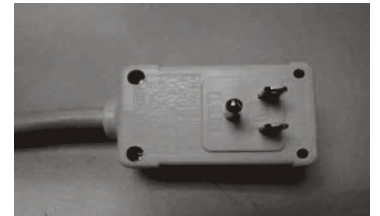

## Recommended Ground Method

For your personal safety, this air conditioner must be grounded. This air conditioner is equipped with a 3 prong power supply cord with a grounded plug. To minimize the possibility of electrical shock, the cord must be plugged into a 3 prong outlet and grounded in accordance with all local codes and ordinances. If a 3 prong outlet is not available, it is the customer's responsibility to have a properly grounded 3 prong outlet installed by a qualified electrician.

### It is the customer's responsibility:

- To contact a qualified electrician.
- To assure that the electrical installation is adequate and in conformance with the National Electrical Code, ANSI/NFPA 70 - latest edition, and all local codes and ordinances.

### Copies of the standards listed may be obtained from:

National Fire Protection Association  
One Batterymarch Park  
Quincy, Massachusetts 02269

## LCDI Power Cord and Plug

This air conditioner is equipped with an LCDI (Leakage Current Detection and Interruption) power cord that is required by UL. This power supply cord contains state-of-the-art electronics that sense leakage current. If the cord is damaged and leakage occurs, power will be disconnected from the unit.

The test and reset buttons on the LCDI Plug are used to check if the plug is functioning properly. To test the plug:

1. Plug power cord into a grounded 3 prong outlet.
2. Press RESET (on some units a green light will turn on).
3. Press the TEST Button, the circuit should trip and cut all power to the air conditioner (on some units a green light may turn off).
4. Press the RESET button for use. You will hear a click and the A/C is now ready for use.







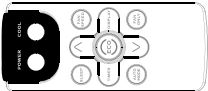
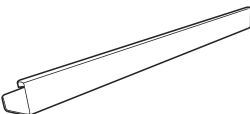

### NOTES:

- The RESET button must be engaged for proper use.
- The power supply cord must be replaced if it fails to trip when the TEST button is pressed and the unit fails to reset.
- Do not use the power supply cord as an ON/OFF switch. The power supply cord is designed as a protection device.
- A damaged power supply cord must be replaced with a new power supply cord.
- The power supply cord contains new user serviceable parts. Opening the tamper-resistant case voids all warranty and performance claims.

NOTE: Your unit's power cord and plug may differ from the one shown.

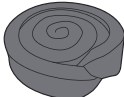

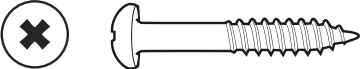
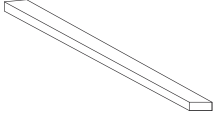
## PACKING LIST

IMAGE	PART	QUANTITY
	Window Air Conditioner	1
	Remote Control	1
	Top Mounting Rail (Putting on the top of package foam with sponge)	1
	Lock Frame	2
	Filler Panels (With "Left" & "Right" on the front face)	2
	Sash Lock (Two holes)	1
	Window Sash Seal (Sponge)	1
	3/8" Screws (only included with BWAC06WT & BWAC08WT)	4
	1/2" Screws	3
	3/4" Screws	4
	Foam Top Window Gasket (Thin sponge for back-up)	1
	Insulation strip (Sponge)	2

## DISCLAIMER

ALL INFORMATION AND THE TECHNICAL SPECIFICATIONS PRESENTED IN THIS USER'S MANUAL ARE THE PRESENTATION OF THE MANUFACTURER.

## INSTALLATION & ASSEMBLY INSTRUCTIONS (USED FOR 6K/8K)

Some assembly is required for your new air conditioner. Please read and follow these instructions carefully.

1. This air conditioner is designed to be installed in a standard double-hung window with a window width between 23" and 36" (584 mm - 914 mm).
2. The air conditioner can be installed without the accordion panels to fit in a narrow window opening. See the window dimensions.
3. The Lower Sash (the lower part of the window that moves up and down) must allow for 14.5" of vertical clearance when open. (See FIG. 1).
4. All supporting parts must be secured to firm wood, masonry, or metal.
5. The electrical outlet must be within reach of the power cord.

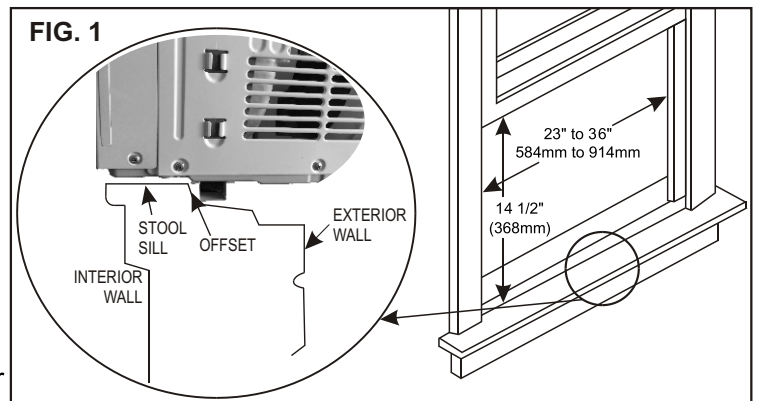

NOTE: Save the product packaging and installation instructions for future reference. Store the air conditioner in the product box when not in use for an extended period of time.

## INSTALLATION & ASSEMBLY INSTRUCTIONS (USED FOR 10K/12K)

Some assembly is required for your new air conditioner. Please read and follow these instructions carefully.

1. This air conditioner is designed to be installed in a standard double-hung window with a window width between 26" and 36" (660 mm - 914 mm).
2. The air conditioner can be installed without the accordion panels to fit in a narrow window opening. See the window dimensions.
3. The Lower Sash (the lower part of the window that moves up and down) must allow for 16" of vertical clearance when open. (See FIG. 2).
4. All supporting parts must be secured to firm wood, masonry, or metal.
5. The electrical outlet must be within reach of the power cord.

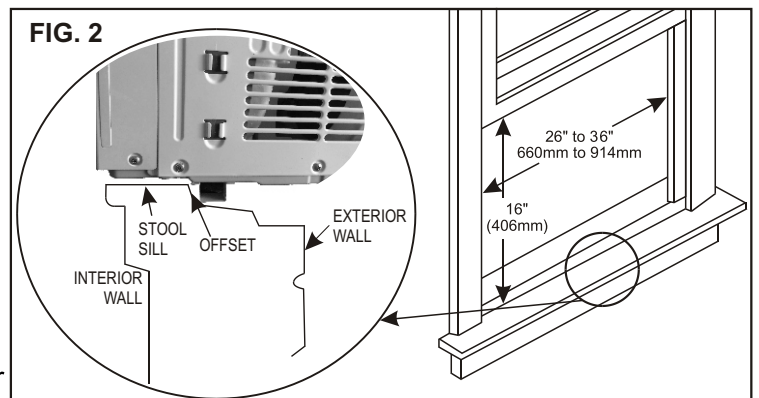



NOTE: Save the product packaging and installation instructions for future reference. Store the air conditioner in the product box when not in use for an extended period of time.



## Top Rail Assembly (Only used for 6K/8K)

The top rail must be assembled prior to installing the air conditioner in the window

**Tools Needed:** Phillips Head Screw Driver

Top Rail Hardware		QTY
	3/8" Screw	4
	Top Rail	1

### Attaching the Top Rail to the Air Conditioner

1. Remove the air conditioner from the box and place on a hard and flat surface.
2. Remove top rail from the bottom of the packaging material as shown in FIG. A.
3. Align the hole in the top rail with those in the top of the unit as shown in FIG. B.
4. Secure the top rail to the unit with the 3/8" Screws as shown in FIG. C.

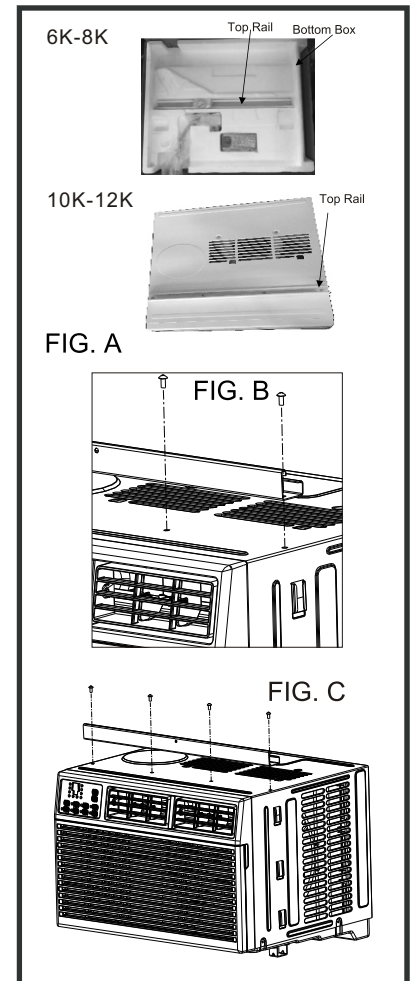

**NOTE:** For safety reasons, all 4 screws must be used to attach the top rail.

## CAUTION

When handling the unit, be careful to avoid cuts from the sharp metal edges and aluminum fins on the front and rear coils.

## MOUNTING HARDWARE



3/4" Screws

Qty

4



Lock Frame

2



Sash Lock

1

### TOOLS NEEDED:

- Phillips Head Screw Driver
- Drill (If pilot holes are needed)

## CAUTION

When handling unit, be careful to avoid cuts from sharp metal edges and aluminum fins on front and rear coils.

## How to Install

**NOTE:** Top Rail and Sliding Panels at each side are offset to provide the proper pitch to the rear of (5/16"). This is necessary for proper condensed water utilization and drainage. If you are not using the Side Panels for any reason, this pitch to the rear must be maintained!

**1**

Place unit on floor, a bench or a table. There is a Left and Right Window Filler Panel - be sure to use the proper panel for each side. When installed the flange for securing the panel in place to the window sill will be facing into the room.

A. Hold the Accordion Panel in one hand and gently pull back the center to free the open end. See Figure 3.

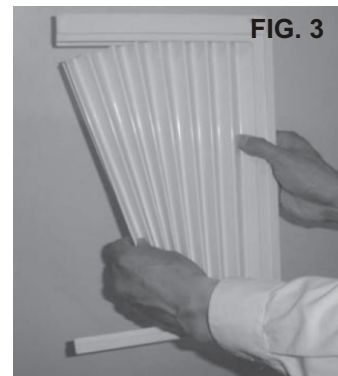

FIG. 3

B. Slide the free end of the panel into the cabinet as shown in Figure 4. Slide the panel down. Be sure to leave enough space to slip the top and bottom of the frame into the rails on the cabinet.

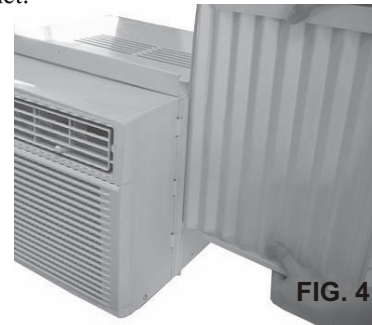

FIG. 4

C. Once the panel has been installed on the side of the cabinet, make sure it sits securely inside the frame channel by making slight adjustments. Slide the top and bottom ends of the frame into the top and bottom rails of the cabinet. Figure 5.



FIG. 5

D. Slide the panel all the way in and repeat on the other side.

**2** Keep a firm grip on the air conditioner, carefully place the unit into the window opening so the bottom of the air conditioner frame is against the window sill (FIG. 6). Carefully close the window behind the top rail of the unit. **(Suggest to keep a downward angle, to let accumulated rain water to drain out, from back side of the unit bottom.)**



**3** Extend the side panels out against the window frame (FIG. 7).



**4** Place the frame lock between the frame extensions and the window sill as shown (Fig. 8). Drive 3/4" (19 mm) locking screws through the frame lock and into the sill (FIG. 9). **NOTE:** To prevent window sill from splitting, drill 1/8" (3 mm) pilot holes before driving screws.



**5** Drive 1/2" (12.7mm) locking screws through frame holes into window sash (FIG. 10/11).



**6** To secure lower sash in place, attach right angle sash lock with 3/4" (19 mm) screw as shown (FIG. 12).



**7** Cut foam seal and insert in the space between the upper and lower sashes (FIG. 13).

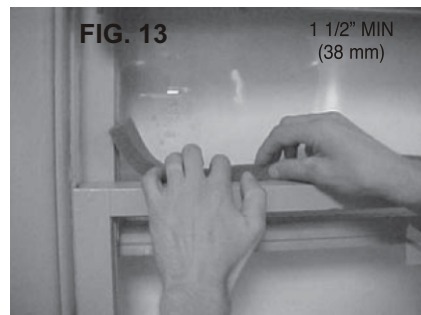

## If AC is Blocked by Storm Window

Add wood as shown in FIG. 14, or remove storm window before air conditioner is installed.

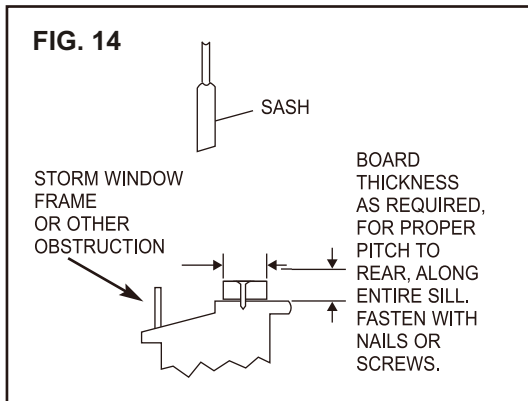

If Storm Window Frame must remain, be sure the drain holes or slots are not caulked or painted shut. Accumulated Rain Water or Condensation must be allowed to drain out.

## Removing AC From Window

- \* Turn AC off, and disconnect power cord.
- \* Remove sash seal from between windows, and unscrew safety lock.
- \* Remove screws installed through frame and frame lock.
- \* Close (slide) side panels into frame.
- \* Keeping a firm grip on air conditioner, raise sash and carefully “rock” air conditioner backward to drain any condensate water in base of unit. Be careful not to spill any remaining water while lifting unit from window. Store parts WITH air conditioner.

## AIR CONDITIONER USE

Operating your air conditioner properly helps you to obtain the best possible results.

This section explains proper air conditioner operation.

### IMPORTANT:

- If you turn off the air conditioner, wait at least 3 minutes before turning it back on. This prevents the air conditioner from blowing a fuse or tripping a circuit breaker.
- Do not try to operate your air conditioner in the cooling mode when outside temperature is below 65°F (18°C). The inside evaporator coil will freeze up, and the air conditioner will not operate properly.

NOTE: In the event of a power failure, your air conditioner will operate at the previous settings when the power is restored.

## USING YOUR AIR CONDITIONER

### Electronic Control Panel & Remote Control

NOTE: This display always shows the room temperature in Fan Mode except when setting the Set temperature or the Timer.

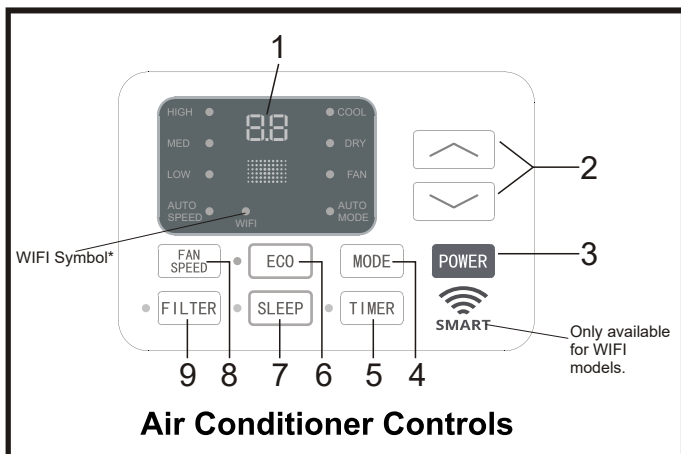

NOTE: “\*” means only available for WIFI modes, For more information, please see the WIFI manual.

### Normal Operating Sounds

- You may hear a pinging noise caused by water hitting the condenser, on rainy days, or when the humidity is high. This design feature helps remove moisture and improve efficiency.
  - You may hear the thermostat click when the compressor cycles on and off.
  - Water will collect in the base pan during rain or days of high humidity. The water may overflow and drip from the outside part of the unit.
  - The fan may run even when the compressor is not on.
- Digital Display:** Shows the set temperature. Operation modes are: Cool, Dry, Fan, and Auto. Time is displayed using the timer setting.
  - ▲ and ▼ Button:** Use these buttons on the control panel and remote to increase or decrease the Set Temperature or Timer. Temperature range: 61°F~88°F or 16°C~31°C.
  - Power Button:** Turn the air conditioner on and off.
  - Mode Button:** Press the mode button to cycle through the various modes: Cool, Dry, Fan and Auto.

**Cool Mode:** The cooling function allows the air conditioner to cool the room and at the same time reduces humidity. Press the MODE button to activate the cooling function. To optimize this function adjust the temperature by pressing the up and down arrows and the speed by pressing the Fan Speed button.

**Dry Mode:** This function reduces the humidity of the air to make the room more comfortable. Press MODE button to set the DRY mode. An automatic function of alternating cooling cycles and air fan is activated.

**Fan Mode:** This mode will only circulate the air. Press MODE button to select FAN MODE. Pressing the FAN SPEED button allows you to change the fan speed setting from HI, MED, and LO. If using the remote control, it will store the fan speed setting of the previous use.

**Auto Mode:** In AUTO mode the unit automatically chooses the fan speed and the mode of operation (COOL, DRY, or FAN). In this mode the fan speed and the temperature are set automatically according to the room temperature (Room temperature is determined by the temperature sensor located in the indoor unit.).

- Timer Button:** Use buttons on the control panel and remote to set the TIMER.

**Timer Off:** The timed stop is programmed by pressing the TIMER button. Set the stop time by pressing the button “▲” or “▼” until your desired stop time is displayed, then press TIMER button again.

**Timer On:** When the unit is off, press TIMER button first, set the temperature with pressing the button “▲” or “▼”. Press TIMER button a second time, set the stop time with pressing the button “▲” or “▼”. Press TIMER button a third time, confirm your settings and stop time. The display will show the time your machine will automatically turn on.

**Note:** It can be set to automatically turn off or on in 0.5-24 hours. Each press of the “▲” “▼” buttons will increase or decrease the timer. The Timer can be set in 0.5 hours increment below 10 hours and 1 hour increment for 10 hours or above. The SET light will turn on while setting. To cancel the set function, press the TIMER button again.

## USING YOUR AIR CONDITIONER

### Electronic Control Panel & Remote Control

6. **Eco Button:** When the unit is in ECO mode, the light will turn on. In ECO mode, the unit will turn-off once the room is cooled to the user set temperature. The fan will also be off at this point. The unit will turn back on when the room temperature rises above the user set temperature. Before the compressor starts, the fan motor will run for a while, then it will stop for a while-and will repeat to provide a much more comfortable-feeling and save energy.
7. **Sleep Button:** Press the SLEEP button, the Sleep Light will be on after 10s. and the remaining lights on the display will be off. In SLEEP mode, the air-conditioner will automatically adjust the temperature and fan speed to make the room more comfortable during the night. The set temperature will automatically raise by 1 °F every 30-60 minutes and at most change six times until the set temperature is 28 °F. Run time will depend on set temperature.
8. **Fan Speed Button:** Press the FAN SPEED button to select the fan speed. In COOL MODE you can choose the following settings: HI, MED, LO, or AUTO. In FAN MODE you can choose from HI, MED, and LO.
9. **Filter Button:** The Filter Check light will only turn on as a reminder to clean the filter after the fan motor has been in operation for a total of 500 hours. To turn the light off, press the Filter Check button.

10. **Directional Louvers:** Use the horizontal wheels to control horizontal airflow and the air deflectors to control vertical airflow.

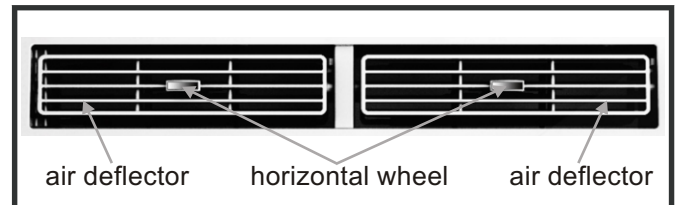

# OPERATING YOUR AIR CONDITIONER

## REMOTE CONTROL

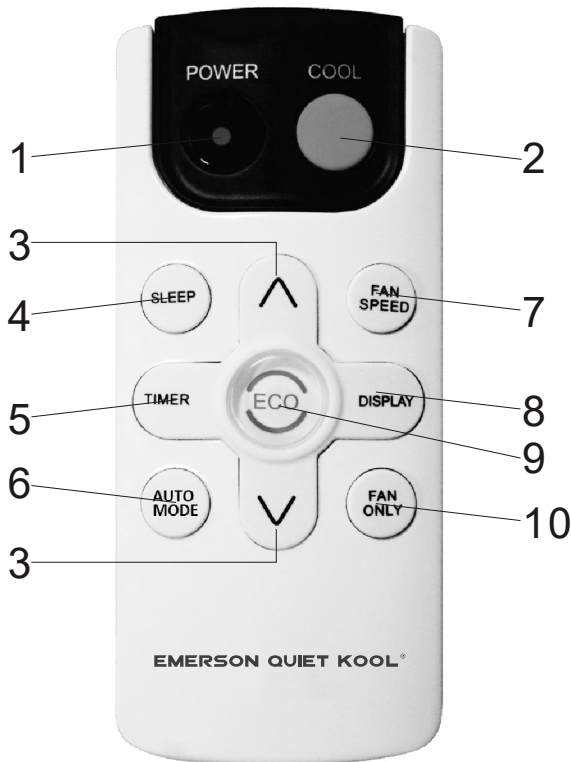

1. **Power:** Turn the air conditioner on and off.
2. **Cool:** Press the COOL button to COOL mode.
3. **^ and v:** Use these buttons on the control panel and remote to increase or decrease the Set Temperature or Timer. Temperature range: 61°F~88°F or 16°C~31°C.
4. **Sleep:** Press the SLEEP button, the Sleep Light will be on after 10s. and the remaining lights on the display will be off. In SLEEP mode, the air-conditioner will automatically adjust the temperature and fan speed to make the room more comfortable during the night. The set temperature will automatically raise by 1 °F every 30-60minutes and at most change six times until the set temperature is 28 °F. And every Run time will depend on set temperature.

5. **Timer:** Use buttons on the control panel and remote to set the TIMER.  
**Timer Off:** The timed stop is programmed by pressing TIMER button. Set the stop time by pressing the button “^” or “v” until your desired stop time is displayed, then press TIMER button again.  
**Timer On:** When the unit is off, press TIMER button first, set the temperature with pressing the button “^” or “v”. Press TIMER button a second time, set the stop time with pressing the button “^” or “v”. Press TIMER button a third time, confirm your settings and stop time. The display will show the time your machine will automatically turn on.  
**Note:** It can be set to automatically turn off or on in 0.5-24 hours. Each press of the “^” “v” buttons will increase or decrease the timer. The Timer can be set in 0.5 hours increment below 10 hours and 1 hour increment for 10 hours or above. The SET light will turn on while setting. To cancel the set function, press the TIMER button again.
6. **Auto Mode:** In AUTO mode the unit automatically chooses the fan speed and the mode of operation (COOL, DRY, or FAN). In this mode the fan speed and the temperature are set automatically according to the room temperature (Room temperature is determined by the temperature sensor located in the indoor unit.).
7. **Fan Speed:** Press the FAN SPEED button to select the fan speed. In COOL MODE you can choose the following settings: HI, MED, LO, or AUTO. In FAN MODE you can choose from HI, MED, and LO.
8. **Display:** To press the DISPLAY button, it can switch off/on all lights or LED display.
9. **Eco:** When the unit is in ECO mode, the light will turn on. In ECO mode, the unit will turn-off once the room is cooled to the user set temperature. The fan will also be off at this point. The unit will turn back on when the room temperature rises above the user set temperature. Before the compressor starts, the fan motor will run for a while, then it will stop for a while-and will repeat to provide a much more comfortable-feeling and save energy.
10. **Fan Only:** Press the Fan Only button to FAN ONLY mode.

Battery Size: AAA - NOTE: Do not mix old and new batteries or different types of AAA batteries.

## CARE AND CLEANING

Clean your air conditioner to keep it looking new and to minimize dust build up.

### Air Filter Cleaning

The air filter should be checked at least once every month to see if it needs cleaning. The Check Filter light will automatically turn on after the fan motor has been in operation for a total of 500 hours. Trapped particles and dust can build up in the filter and may decrease airflow as well as cause the cooling coils to accumulate frost.

To clean the air filter:

1. Remove the filter by pulling down on the indents of the filter door on the front of the unit. (See FIG. 15)
2. Wash the filter using liquid dish soap and warm water. Rinse the filter thoroughly. Gently shake the filter to remove excess water.
3. Let the filter dry completely before placing it into the air conditioner.
4. If you do not wish to wash the filter, you may vacuum the filter to remove the dust and other particles.

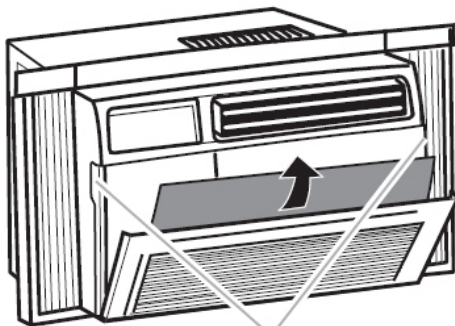

FIG. 15

A  
A. Indents

### Wear and Tear

To minimize wear and tear on the air conditioner, always wait at least 3 minutes before changing modes. This will help prevent the compressor from overheating and the circuit breaker from tripping.

### Cabinet Cleaning

To clean the air conditioner cabinet:

- Unplug the air conditioner to prevent shock or a fire hazard. The cabinet and front panel of the air conditioner may be dusted with an oil-free cloth or washed with a cloth dampened in a solution of warm water and mild liquid soap. Rinse thoroughly with a damp cloth and wipe dry.
- Never use harsh cleaners, wax or polish on the cabinet front.
- Be sure to wring excess water from the cloth before wiping around the controls. Excess water in or around the controls may cause damage to the air conditioner.

### Winter Storage

To store the air conditioner when it is not in use for an extended period of time, remove it carefully from the window according to the installation instructions and cover it with plastic or place it in the original box.



## TROUBLESHOOTING

PROBLEM	POSSIBLE CAUSES	SOLUTIONS
<b>The Air Conditioner will not start</b>	The air conditioner is unplugged.	<ul style="list-style-type: none"> <li>• Make sure the air conditioner plug is pushed completely into the outlet.</li> </ul>
	The fuse is blown/circuit breaker is tripped.	<ul style="list-style-type: none"> <li>• Check the house fuse/circuit breaker box and replace the fuse or reset the breaker.</li> </ul>
	Power failure.	<ul style="list-style-type: none"> <li>• The unit will automatically re-start when power is restored.</li> <li>• There is a protective time delay (approx. 3 minutes) to prevent tripping of the compressor overload. For this reason, the unit may not start normal cooling for 3 minutes after it is turned back on.</li> </ul>
	The current interrupter device is tripped.	<ul style="list-style-type: none"> <li>• Press the RESET button located on the power cord plug.</li> <li>• If the RESET button will not stay engaged, discontinue use of the air conditioner and contact a qualified service technician.</li> </ul>
<b>The Air Conditioner does not cool as it should</b>	Airflow is restricted.	<ul style="list-style-type: none"> <li>• Make sure there are no curtains, blinds, or furniture blocking the front of the air conditioner.</li> </ul>
	The temperature control may not be set correctly.	<ul style="list-style-type: none"> <li>• Lower the set thermostat temperature.</li> </ul>
	The air filter is dirty.	<ul style="list-style-type: none"> <li>• Clean the filter. See the Cleaning and Care Section of the manual.</li> </ul>
	The room may be too warm.	<ul style="list-style-type: none"> <li>• Please allow time for the room to cool down after turning on the air conditioner.</li> </ul>
	Cold air is escaping.	<ul style="list-style-type: none"> <li>• Check for open furnace registers and cold air returns.</li> </ul>
	The cooling coils are frozen.	<ul style="list-style-type: none"> <li>• See "Air Conditioner Freezing Up" below.</li> </ul>
<b>The Air Conditioner is freezing up</b>	Ice blocks the air flow and stops the air conditioner from cooling the room.	<ul style="list-style-type: none"> <li>• Set the MODE dial to HIGH FAN or HIGH COOL and set the thermostat to a higher temperature.</li> </ul>
<b>The Remote Control is not working</b>	The batteries are inserted incorrectly.	<ul style="list-style-type: none"> <li>• Check the position of the batteries.</li> </ul>
	The batteries may be dead.	<ul style="list-style-type: none"> <li>• Replace the batteries.</li> </ul>

## TROUBLESHOOTING (CONT.)

<b>PROBLEM</b>	<b>POSSIBLE CAUSES</b>	<b>SOLUTIONS</b>
<b>Water is dripping outside</b>	Hot and humid weather.	<ul style="list-style-type: none"><li>• This is normal.</li></ul>
<b>Water is dripping inside the room</b>	The air conditioner is not correctly tilted outside.	<ul style="list-style-type: none"><li>• For proper water drainage, make sure the air conditioner is slightly tilted downward from the front of the unit to the rear.</li></ul>
<b>Water collects in the base pan</b>	Moisture removed from the air is draining into the base pan.	<ul style="list-style-type: none"><li>• This is normal for a short period in areas with low humidity and normal for a longer period in areas with high humidity.</li></ul>

For any questions or Technical Support,  
Please Call Customer Service: 1-844-801-8880



**EMERSON QUIET KOOL<sup>®</sup>**