

**EMERSON**  
QUIET KOOL®

# OWNER'S MANUAL

**5000 BTU**

MODEL:  
EARC5RD1



**WINDOW AIR  
CONDITIONER**



## THANK YOU!

Congratulations on your purchase and welcome to the EMERSON QUIET KOOL® Family. Your new EMERSON QUIET KOOL® Air Conditioner combines high-efficiency operation with portable convenience.

By following the operating and care instructions in this manual, your air conditioner will provide you with many years of reliable service.

---

# INTRODUCTION

IMPORTANT SAFETY INSTRUCTION .....	1
ELECTRICAL REQUIREMENTS .....	2
PACKING LIST .....	3
INSTALLATION & ASSEMBLY INSTRUCTIONS .....	4
USING YOUR AIR CONDITIONER .....	7
CARE AND CLEANING .....	10
TROUBLESHOOTING .....	11

## IMPORTANT SAFETY INSTRUCTIONS

Before installing and using your air conditioner, please read this owner's manual carefully. Store this manual in a safe place for future reference. Your safety and the safety of others is very important to us. Please pay attention to all safety messages outlined in this owner's manual.

**WARNING:** To reduce the risk of fire, electrical shock or injury when using your air conditioner, follow the basic precautions below:

- Plug into a grounded 3 prong outlet.
- Do not remove the ground prong.
- Do not use a plug adapter.
- Do not use an extension cord.
- Unplug the air conditioner before servicing.
- Use two or more people to move and install the air conditioner.



This is a safety alert symbol.

This symbol alerts you to potential hazards that can harm you or others or even cause death.

All safety messages will directly follow the safety alert symbol and/or the words "DANGER" or "WARNING".

**⚠ DANGER**

**⚠ WARNING**

Failure to immediately follow these instructions may cause serious injury or even death.

All Safety messages alert you of potential hazards, how to reduce the chance of injury, and what can happen if instructions are not followed correctly.

## ELECTRICAL REQUIREMENTS

### ⚠ WARNING



#### Electrical Shock Hazard

Plug into a grounded 3 prong outlet.  
Do not remove the ground prong.  
Do not use an adapter.  
Do not use an extension cord.  
Failure to follow these instructions can result in death, fire, or electrical shock.

The electrical ratings for your air conditioner are listed on the model and serial number label located on the front left side of the unit (when facing the front).

Specific electrical requirements are listed in the chart below. Follow the requirements below for the type of plug on the power supply cord.

#### Wiring Requirements

- 115 volt (103 min.—127 max)
- 0-8 amps
- 10-amp time-delay fuse or circuit breaker
- Use on single outlet circuit only

#### Power Supply Cord

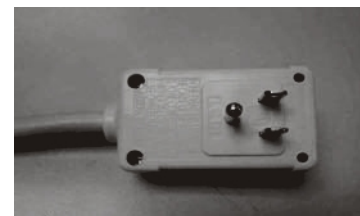

### Recommended Ground Method

For your personal safety, this air conditioner must be grounded. This air conditioner is equipped with a 3 prong power supply cord with a grounded plug. To minimize the possibility of electrical shock, the cord must be plugged into a 3 prong outlet and grounded in accordance with all local codes and ordinances. If a 3 prong outlet is not available, it is the customer's responsibility to have a properly grounded 3 prong outlet installed by a qualified electrician.

#### It is the customer's responsibility:

- To contact a qualified electrician.
- To assure that the electrical installation is adequate and in conformance with the National Electrical Code, ANSI/NFPA 70 - latest edition, and all local codes and ordinances.

#### Copies of the standards listed may be obtained from:

National Fire Protection Association  
One Batterymarch Park  
Quincy, Massachusetts 02269

### LCDI Power Cord and Plug

This air conditioner is equipped with an LCDI (Leakage Current Detection and Interruption) power cord and plug as required by US National Electric Code 440.65. This cord consists of a length of shielded flexible cord with no termination on the load side and a LCDI attachment plug on the line side.

The LCDI power cord and plug will remove the supply source via electrical disconnect (circuit trip) if the nominal current leakage between the cord shield and either load conductor exceeds a predetermined value. The cord will remain de-energized until the device has been manually reset. This is intended to reduce the risk of a fire in the power cord or combustible materials nearby. The cord shields are not grounded and they must be considered a shock hazards if exposed. The cord shield must not be connected to ground or to any exposed metal.

The test and reset buttons on the LCDI Plug are used to check if the plug is functioning properly. To test the plug:





1. Plug power cord into a wall outlet
2. Press the TEST Button, the circuit should trip and cut all power to the air conditioner
3. Press the RESET button for use

If a test is performed and the indicator light remains ON, the current leakage has been detected. Do not use the air conditioner or attempt to reset the LCDI Plug. Contact Customer Service for troubleshooting recommendations.

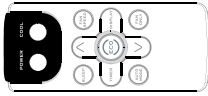
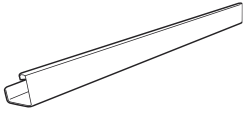
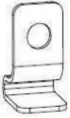

## PACKING LIST

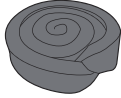
(appearance may vary)

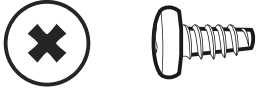
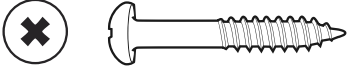
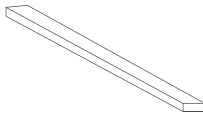
IMAGE	PART	QUANTITY
	Window Air Conditioner	1
	Remote Control	1
	Top Mounting Rail (Putting on the top of package foam with sponge)	1
	Lock Frame	2
	Filler Panels (With "Left" & "Right" on the front face)	2
	Sash Lock (Two holes)	1
	Window Sash Seal (Sponge)	1
	3/8" Screws	4
	1/2" Screws	3
	3/4" Screws	4
	Foam Top Window Gasket (Thin sponge for back-up)	1

## DISCLAIMER

ALL INFORMATION AND THE TECHNICAL SPECIFICATIONS PRESENTED IN THIS USER'S MANUAL ARE THE PRESENTATION OF THE MANUFACTURER. SOLEUS INTERNATIONAL HAS NOT CONDUCTED INDEPENDENT TEST TO THE INFORMATION AND THE SPECIFICATIONS PRESENTED HEREWITHIN.

# INSTALLATION & ASSEMBLY INSTRUCTIONS

Some assembly is required for your new air conditioner. Please read and follow these instructions carefully.

1. This air conditioner is designed to be installed in a standard double-hung window with a window width between 23" and 36" (584 mm - 914 mm).
2. The air conditioner can be installed without the accordion panels to fit in a narrow window opening. See the window dimensions.
3. The Lower Sash (the lower part of the window that moves up and down) must allow for 14.5" of vertical clearance when open. (See FIG. 1).
4. All supporting parts must be secured to firm wood, masonry, or metal.
5. The electrical outlet must be within reach of the power cord.

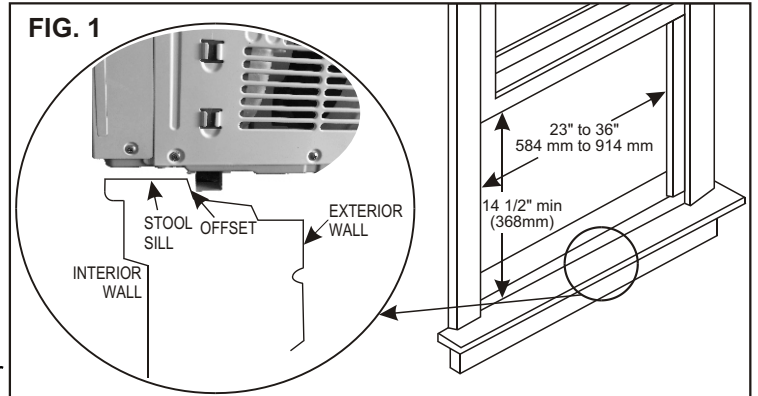



NOTE: Save the product packaging and installation instructions for future reference. Store the air conditioner in the product box when not in use for an extended period of time.

## Top Rail Assembly

The top rail must be assembled prior to installing the air conditioner in the window

**Tools Needed:** Phillips Head Screw Driver

Top Rail Hardware		QTY
	3/8" Screw	4
	Top Rail	1

### Attaching the Top Rail to the Air Conditioner

1. Remove the air conditioner from the box and place on a hard and flat surface.
2. Remove top rail from the top of the packaging material as shown in FIG. A.
3. Align the hole in the top rail with those in the top of the unit as shown in FIG. B.
4. Secure the top rail to the unit with the 3/8" screws as shown in FIG. C.

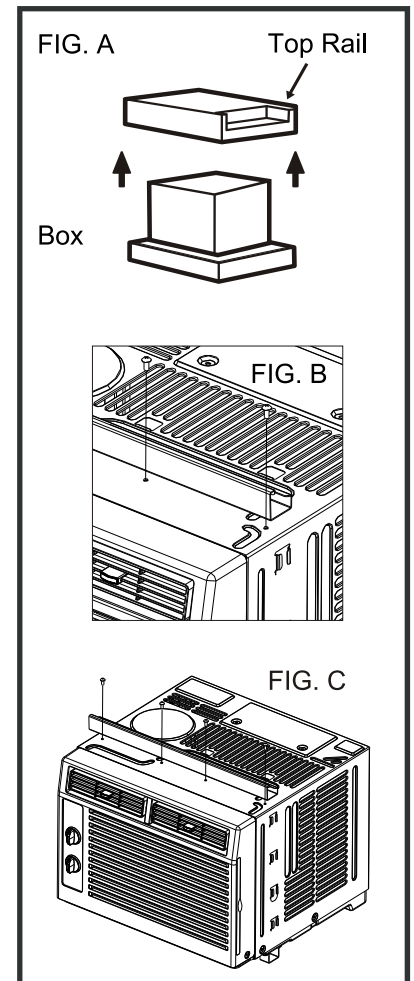

NOTE: For safety reasons, all 4 screws must be used to attach the top rail.

## CAUTION

When handling the unit, be careful to avoid cuts from the sharp metal edges and aluminum fins on the front and rear coils.



## ASSEMBLY & INSTALLATION (CONT.)

### Accordion Panel Installation

Now that you have installed the top rail, you can now install the accordion panels on each side.

1. Place the air conditioner on a hard flat surface.
2. Locate the accordion panels in the box.
3. Gently pull the free end of the accordion panel (See FIG. 2). Do this for both panels.

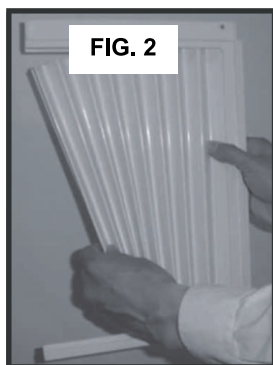

4. Slide the free end of the accordion panel into the side panel of the air conditioner (See FIG. 3). Do this for each side.



5. Once the accordion panels are slid into place adjust the top and bottom rails of the accordion panels into the top and bottom rails of the air conditioner (See FIG. 4).



### Storm Window Requirements

A storm window frame will not allow the air conditioner to tilt properly which in turn will keep it from draining properly. To adjust for this, attach a board or piece of wood to the sill. The board or wood piece should have a depth of at least 1 1/2". Make sure the board or piece of wood is approximately 1/2" higher than the storm window frame. This will allow the air conditioner to tilt enough for proper drainage. (See FIG. 5).

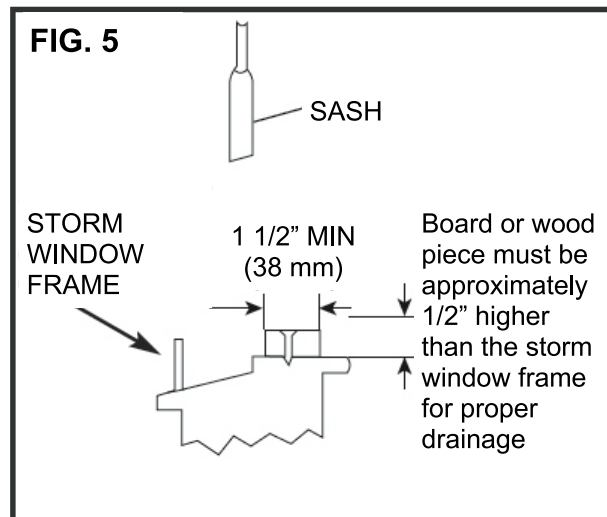

### Placing the Unit Inside a Window

1. Place the air conditioner on the sill with the bottom mounting rail against its back edge. Center the air conditioner and close the window securely behind the top mounting rail. The air conditioner should be slightly tilted to the outside area. Use a level; about a 1/3 bubble will be the correct case slant to the outside. (See FIG. 6 & FIG. 7) (**Suggest to keep a downward angle, to let accumulated rain water to drain out, from back side of the unit bottom.**)

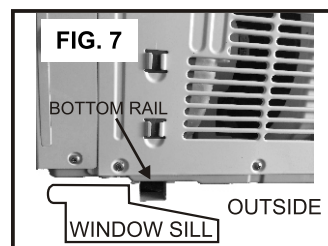
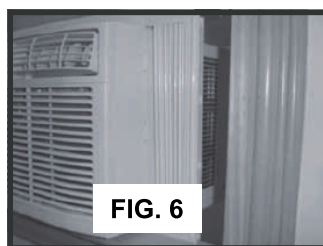

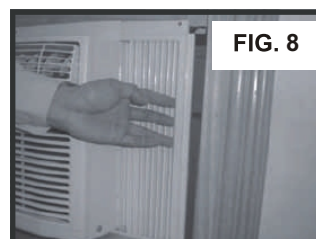

2. Once the air conditioner is placed, extend both the left and right accordion panels to the width of the window.

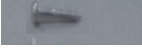

## ASSEMBLY & INSTALLATION (CONT.)

### Frame Lock, Sash Lock, and Foam Seal Installation

MOUNTING HARDWARE		
	3/4" Screws	Qty 4
	1/2" Screws	3
	Frame Lock	2
	Sash Lock	1

#### **Tools Needed:**

Phillips Head Screw Driver  
Drill (if pilot holes are needed)

- Place the frame lock between the extended accordion panels and the window sill as show in FIG. 9. Screw a 3/4" (19 mm) locking screw through the frame lock and into the window sill. (FIG. 10)



- Drive 1/2" screws into the top of the accordion panel frame and the top rail to securely attach the window air conditioner to the lower sash. (See FIG. 11/12)

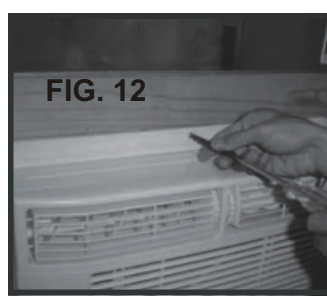

- To secure the lower sash into place, use the sash lock and a 3/4" screw as shown below. (See FIG. 13)



- For added insulation, cut the supplied insulation foam to the width of the window. Insert the foam between the window sashes to prevent air and objects from getting into the room. (See FIG. 14)



### Removing the Air Conditioner from the Window

- Turn the air conditioner off, and disconnect the power cord.
- Remove the sash seal from between windows, and unscrew sash lock.
- Remove the screws installed through the frame and frame lock.
- Close (slide) the side panels into frame.
- Keeping a firm grip on air conditioner, raise the sash and carefully "rock" air conditioner backward to drain any condensate water in base of unit. Be careful not to spill any remaining water while lifting unit from window.
- Store parts WITH the air conditioner in the box.

## USING YOUR AIR CONDITIONER Manual Control Panel

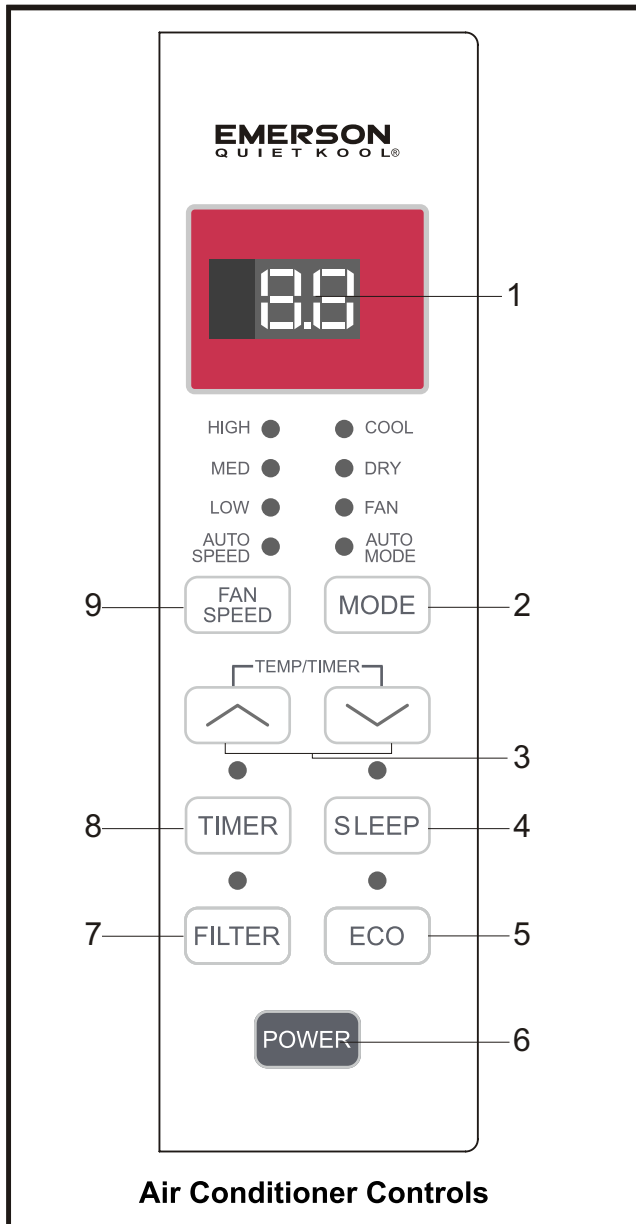

### Normal Operating Sounds

- You may hear a pinging noise caused by water hitting the condenser, on rainy days, or when the humidity is high. This design feature helps remove moisture and improve efficiency.
- You may hear the thermostat click when the compressor cycles on and off.
- Water will collect in the base pan during rain or days of high humidity. The water may overflow and drip from the outside part of the unit.
- The fan may run even when the compressor is not on.

1. **Digital Display:** Shows the set temperature. Operation modes are: Cool, Dry, Fan, and Auto. Time is displayed using the timer setting.
2. **Mode Button:** Press the mode button to cycle through the various modes: Cool, Dry, Fan and Auto.
 

**Cool Mode:** The cooling function allows the air conditioner to cool the room and at the same time reduces humidity. Press the MODE button to activate the cooling function. To optimize this function adjust the temperature by pressing the up and down arrows and the speed by pressing the Fan Speed button.

**Dry Mode:** This function reduces the humidity of the air to make the room more comfortable. Press MODE button to set the DRY mode. An automatic function of alternating cooling cycles and air fan is activated.

**Fan Mode:** This mode will only circulate the air. Press MODE button to select FAN MODE. Pressing the FAN SPEED button allows you to change the fan speed setting from HI, MED, and LO. If using the remote control, it will store the fan speed setting of the previous use.

**Auto Mode:** In AUTO mode the unit automatically chooses the fan speed and the mode of operation (COOL, DRY, or FAN). In this mode the fan speed and the temperature are set automatically according to the room temperature (Room temperature is determined by the temperature sensor located in the indoor unit.).
3. **^ and v Button:** Use these buttons on the control panel and remote to increase or decrease the Set Temperature or Timer. Temperature range: 61°F~88°F or 16°C~31°C.
4. **Sleep Button:** Press the SLEEP button, the Sleep Light will be on after 10s. and the remaining lights on the display will be off. In SLEEP mode, the air-conditioner will automatically adjust the temperature and fan speed to make the room more comfortable during the night. The set temperature will automatically raise by 1 °F every 30-60 minutes and at most change six times until the set temperature is 28 °F. Run time will depend on set temperature.

5. **Eco Button:** When the unit is in ECO mode, the light will turn on. In ECO mode, the unit will turn-off once the room is cooled to the user set temperature. The fan will also be off at this point. The unit will turn back on when the room temperature rises above the user set temperature. Before the compressor starts, the fan motor will run for a while, then it will stop for a while-and will repeat to provide a much more comfortable-feeling and save energy.

6. **Power Button:** Turn the air conditioner on and off.

7. **Filter Button:** The Filter Check light will only turn on as a reminder to clean the filter after the fan motor has been in operation for a total of 500 hours. To turn the light off, press the Filter Check button.

8. **Timer Button:** Use these buttons on the control panel and remote to set the Timer.  
**Timer Off:** The timed stop is programmed by pressing the TIMER button. Set the stop time by pressing the button “^” or “v” until your desired stop time is displayed, then press TIMER button again.  
**Timer On:** When the unit is off, press TIMER button first, set the temperature with pressing the button “^” or “v” . Press TIMER button a second time, set the stop time with pressing the button “^” or “v” . Press TIMER button a third time, confirm your settings and stop time. The display will show the time your machine will automatically turn on.

**Note:** It can be set to automatically turn off or on in 0.5-24 hours. Each press of the “^” “v” buttons will increase or decrease the timer. The Timer can be set in 0.5 hours increment below 10 hours and 1 hour increment for 10 hours or above. The SET light will turn on while setting. To cancel the set function, press the TIMER button again.

9. **Fan Speed Button:** Press the FAN SPEED button to select the fan speed. In COOL MODE you can choose the following settings: HI, MED, LO, or AUTO. In FAN MODE you can choose from HI, MED, and LO.

10. **Directional Louvers:** Use the horizontal wheels to control horizontal airflow and the air deflectors to control vertical airflow.

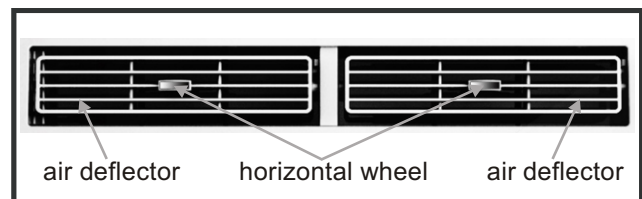

# OPERATING YOUR AIR CONDITIONER

## REMOTE CONTROL

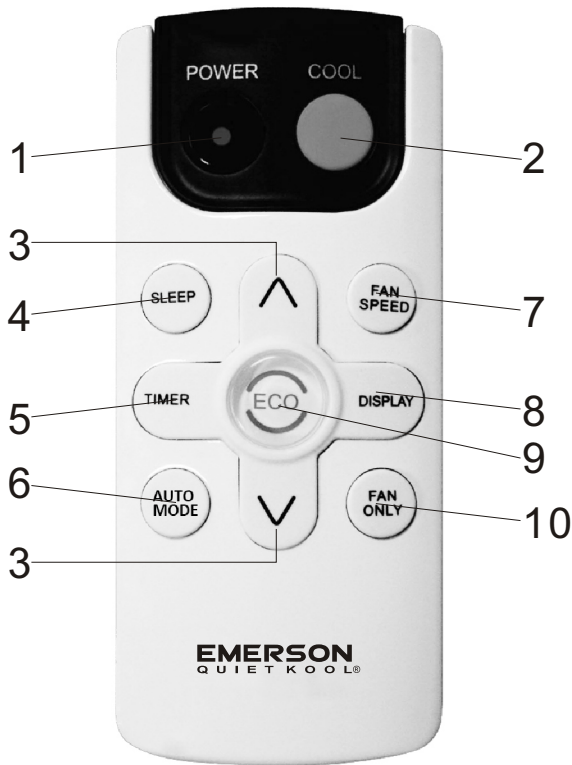

1. **Power:** Turn the air conditioner on and off.
2. **Cool:** Press the COOL button to COOL mode.
3. **^ and v:** Use these buttons on the control panel and remote to increase or decrease the Set Temperature or Timer. Temperature range: 61°F~88°F or 16°C~31°C.
4. **Sleep:** Press the SLEEP button, the Sleep Light will be on after 10s. and the remaining lights on the display will be off. In SLEEP mode, the air-conditioner will automatically adjust the temperature and fan speed to make the room more comfortable during the night. The set temperature will automatically raise by 1 °F every 30-60minutes and at most change six times until the set temperature is 28 °F. And every Run time will depend on set temperature.

5. **Timer:** Use buttons on the control panel and remote to set the TIMER.  
**Timer Off:** The timed stop is programmed by pressing TIMER button. Set the stop time by pressing the button “^” or “v” until your desired stop time is displayed, then press TIMER button again.  
**Timer On:** When the unit is off, press TIMER button first, set the temperature with pressing the button “^” or “v”. Press TIMER button a second time, set the stop time with pressing the button “^” or “v”. Press TIMER button a third time, confirm your settings and stop time. The display will show the time your machine will automatically turn on.  
**Note:** It can be set to automatically turn off or on in 0.5-24 hours. Each press of the “^” “v” buttons will increase or decrease the timer. The Timer can be set in 0.5 hours increment below 10 hours and 1 hour increment for 10 hours or above. The SET light will turn on while setting. To cancel the set function, press the TIMER button again.
6. **Auto Mode:** In AUTO mode the unit automatically chooses the fan speed and the mode of operation (COOL, DRY, or FAN). In this mode the fan speed and the temperature are set automatically according to the room temperature (Room temperature is determined by the temperature sensor located in the indoor unit.).
7. **Fan Speed:** Press the FAN SPEED button to select the fan speed. In COOL MODE you can choose the following settings: HI, MED, LO, or AUTO. In FAN MODE you can choose from HI, MED, and LO.
8. **Display:** To press the DISPLAY button, it can switch off/on all lights or LED display.
9. **Eco:** When the unit is in ECO mode, the light will turn on. In ECO mode, the unit will turn-off once the room is cooled to the user set temperature. The fan will also be off at this point. The unit will turn back on when the room temperature rises above the user set temperature. Before the compressor starts, the fan motor will run for a while, then it will stop for a while-and will repeat to provide a much more comfortable-feeling and save energy.
10. **Fan Only:** Press the Fan Only button to FAN ONLY mode.

Battery Size: AAA - NOTE: Do not mix old and new batteries or different types of AAA batteries.

## CARE AND CLEANING

Clean your air conditioner to keep it looking new and to minimize dust build up.

### Air Filter Cleaning

The air filter should be checked at least once every month to see if it needs cleaning. Trapped particles and dust can build up in the filter and may decrease airflow as well as cause the cooling coils to accumulate frost. To clean the air filter:

1. Remove the filter by sliding it out from the front right side of the air conditioner. (See FIG. 15)
2. Wash the filter using liquid dish soap and warm water. Rinse the filter thoroughly. Gently shake the filter to remove excess water.
3. Let the filter dry completely before placing it into the air conditioner.
4. If you do not wish to wash the filter, you may vacuum the filter to remove the dust and other particles.

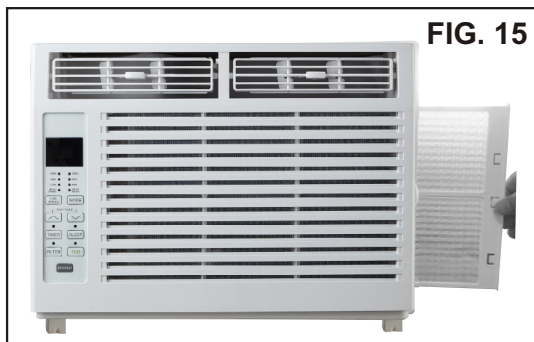

### Cabinet Cleaning

To clean the air conditioner cabinet:

- Unplug the air conditioner to prevent shock or a fire hazard. The cabinet and front panel of the air conditioner may be dusted with an oil-free cloth or washed with a cloth dampened in a solution of warm water and mild liquid soap. Rinse thoroughly with a damp cloth and wipe dry.
- Never use harsh cleaners, wax or polish on the cabinet front.
- Be sure to wring excess water from the cloth before wiping around the controls. Excess water in or around the controls may cause damage to the air conditioner.

### Winter Storage

To store the air conditioner when it is not in use for an extended period of time, remove it carefully from the window according to the installation instructions and cover it with plastic or place it in the original box.

## TROUBLESHOOTING

PROBLEM	POSSIBLE CAUSES	SOLUTIONS
<b>The Air Conditioner will not start</b>	The air conditioner is unplugged.	<ul style="list-style-type: none"> <li>Make sure the air conditioner plug is pushed completely into the outlet.</li> </ul>
	The fuse is blown/circuit breaker is tripped.	<ul style="list-style-type: none"> <li>Check the house fuse/circuit breaker box and replace the fuse or reset the breaker.</li> </ul>
	Power failure.	<ul style="list-style-type: none"> <li>The unit will automatically re-start when power is restored.</li> <li>There is a protective time delay (approx. 3 minutes) to prevent tripping of the compressor overload. For this reason, the unit may not start normal cooling for 3 minutes after it is turned back on.</li> </ul>
	The current interrupter device is tripped.	<ul style="list-style-type: none"> <li>Press the RESET button located on the power cord plug.</li> <li>If the RESET button will not stay engaged, discontinue use of the air conditioner and contact a qualified service technician.</li> </ul>
<b>The Air Conditioner does not cool as it should</b>	Airflow is restricted.	<ul style="list-style-type: none"> <li>Make sure there are no curtains, blinds, or furniture blocking the front of the air conditioner.</li> </ul>
	The temperature control may not be set correctly.	<ul style="list-style-type: none"> <li>Lower the set thermostat temperature.</li> </ul>
	The air filter is dirty.	<ul style="list-style-type: none"> <li>Clean the filter. See the Cleaning and Care Section of the manual.</li> </ul>
	The room may be too warm.	<ul style="list-style-type: none"> <li>Please allow time for the room to cool down after turning on the air conditioner.</li> </ul>
	Cold air is escaping.	<ul style="list-style-type: none"> <li>Check for open furnace registers and cold air returns.</li> </ul>
	The cooling coils are frozen.	<ul style="list-style-type: none"> <li>See "Air Conditioner Freezing Up" below.</li> </ul>
<b>The Air Conditioner is freezing up</b>	Ice blocks the air flow and stops the air conditioner from cooling the room.	<ul style="list-style-type: none"> <li>Set the MODE dial to HIGH FAN or HIGH COOL and set the thermostat to a higher temperature.</li> </ul>
<b>The Remote Control is not working</b>	The batteries are inserted incorrectly.	<ul style="list-style-type: none"> <li>Check the position of the batteries.</li> </ul>
	The batteries may be dead.	<ul style="list-style-type: none"> <li>Replace the batteries.</li> </ul>

## TROUBLESHOOTING (CONT.)

<b>PROBLEM</b>	<b>POSSIBLE CAUSES</b>	<b>SOLUTIONS</b>
<b>Water is dripping outside</b>	Hot and humid weather.	<ul style="list-style-type: none"><li>• This is normal.</li></ul>
<b>Water is dripping inside the room</b>	The air conditioner is not correctly tilted outside.	<ul style="list-style-type: none"><li>• For proper water drainage, make sure the air conditioner is slightly tilted downward from the front of the unit to the rear.</li></ul>
<b>Water collects in the base pan</b>	Moisture removed from the air is draining into the base pan.	<ul style="list-style-type: none"><li>• This is normal for a short period in areas with low humidity and normal for a longer period in areas with high humidity.</li></ul>

For any questions or Technical Support,  
Please Call Customer Service: 1-844-801-8880





**EMERSON**  
QUIET KOOL®