

# Galanz

User Manual

Model#**GL1FR24ASSARN**



Thank you for purchasing a Galanz product. Please read this manual carefully for correct usage and safety, and keep for future reference. For service, support and warranty information, call 800-562-0738.

# INSTALLATION REQUIREMENTS

- Range must be connected to the proper electrical voltage and frequency as specified on the model/serial number rating plate. All models are dual rated, and designed to be connected to either 120/208 or 120/240V AC, 60Hz, 3-wire or 4-wire, single-phase power supply.

Voltage and Frequency	Amps	Minimum Circuit Required
240V, 60 Hz	37.3A	40 Amp Circuit
208V, 60 Hz	32.4A	35 Amp Circuit

- Install a suitable conduit box (not furnished). An appropriately sized, UL conduit connector must be used to correctly attach the conduit to the junction box.

**IMPORTANT:** Local Codes may vary; installation electrical connections and grounding must comply with all applicable local codes.

The range is not equipped with a power cord. The range can be fitted with a 3 or 4-wire NEMA 10-50 or 14-50 type SRDT or ST (as required) power cord rated at 250 volt AC minimum, 40 amp, with ring terminals or open-end spade terminals with upturned ends and marked for use with ranges.

- A UL listed strain relief must be attached to the range to hold the power cord.
- Do not use an aluminum wire receptacle with copper-wired power cord and plug (or vice versa). The proper wiring and receptacle is a copper-wired power cord with a copper-wired receptacle.
- The electrical outlet should be located so that the power cord is accessible when the range is in the installed position.



# CONTENT

CONTENT

<b>RANGE SAFETY</b> .....	2
The Anti-tip Bracket .....	2
IMPORTANT SAFETY INSTRUCTIONS.....	3
<b>PARTS AND FEATURES</b> .....	6
<b>ELECTRONIC CONTROL</b> .....	7
Setting the Clock and Timer .....	7
Timed Cooking.....	8
<b>ELEMENT AND CONTROL SETTING</b> .....	8
Heating Elements .....	9
Control Knobs .....	10
<b>COOKTOP USE</b> .....	11
Before Using the Cooktop.....	11
Cookware .....	11
Observe the Following Points in Canning .....	12
<b>OVEN USE</b> .....	14
Before Using the Oven .....	14
General .....	14
Oven Modes .....	15
Bake Tips and Techniques .....	16
Convection Bake Tips and Techniques .....	17
Convection Roast Tips and Techniques .....	19
Convection Broil Tips and Techniques .....	20
<b>RANGE CARE</b> .....	21
<b>OVEN DOOR REMOVAL</b> .....	23
Replacing an Oven Light .....	25
<b>TROUBLESHOOTING</b> .....	26
<b>LIMITED WARRANTY</b> .....	29
<b>WARRANTY REGISTRATION</b> .....	30

# RANGE SAFETY

## RANGE SAFETY

**Your safety and the safety of others are very important.**

We have provided many important safety messages in this manual and on your appliance. Always read and obey all safety messages.



This is the safety alert symbol. This symbol alerts you to potential hazards that can kill or hurt you and others. All safety messages will follow the safety alert symbol and either the word “DANGER,” “WARNING” or “CAUTION.” These words mean:



An imminently hazardous situation. You could be

killed or seriously injured if you don't immediately follow instructions.



A potentially hazardous situation which, if not avoided, could result in death or serious bodily injury.



A potentially hazardous situation which, if not

avoided, may result in moderate or minor injury. All safety messages will tell you what the potential hazard

is, tell you how to reduce the chance of injury, and tell you what can happen if the instructions are not followed.

## THE ANTI-TIP BRACKET

**⚠ WARNING**



### Tip Over Hazard

A child or adult can tip the range and be killed.

Connect anti-tip bracket to rear range foot. Reconnect the anti-tip bracket, if the range is moved. See the installation instructions for details. Failure to follow these instructions can result in death or serious burns to children and adults.

Making sure the anti-tip bracket is installed:

- Slide range forward.
- Look for the anti-tip bracket securely attached to floor.
- Slide range back so rear range foot is under anti-tip bracket.

**Anti-Tip Bracket**

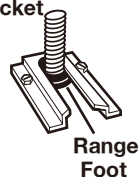

**Range Foot**

# RANGE SAFETY

## IMPORTANT SAFETY INSTRUCTIONS

**WARNING:** To reduce the risk of fire, electrical shock, injury to persons, or damage when using the range, follow basic precautions, including the following:

- **WARNING:** TO REDUCE THE RISK OF TIPPING OF THE RANGE, THE RANGE MUST BE SECURED BY PROPERLY INSTALLED ANTI-TIP DEVICES. TO CHECK IF THE DEVICES ARE INSTALLED PROPERLY, SLIDE RANGE COMPLETELY FORWARD, LOOK FOR ANTI-TIP BRACKET SECURELY ATTACHED TO THE FLOOR BEHIND THE RANGE AND SLIDE RANGE COMPLETELY BACK UNTIL THE REAR RANGE FOOT IS UNDER ANTI-TIP BRACKET.
- **WARNING:** NEVER use this appliance as a space heater to heat or warm the room. Doing so may result in carbon monoxide poisoning and overheating of the oven.
- **WARNING:** NEVER cover any slots, holes or passages in the oven bottom or cover an entire rack with materials such as aluminum foil.

Doing so blocks airflow through the oven and may cause carbon monoxide poisoning. Aluminum foil linings may also trap heat, causing a fire hazard.

- **CAUTION:** Do not store items of interest to children in cabinets above a range or on the back guard of a range – children climbing on the range to reach items could be seriously injured.
- Do Not Leave Children Alone – Children should not be left alone or unattended in area where the range is in use. They should never be allowed to sit or stand on any part of the range.
- Wear Proper Apparel – Loose-fitting or hanging garments should never be worn while using the range.
- User Servicing – Do not repair or replace any part of the range unless specifically recommended in the manual.
- All other servicing should be referred to a qualified technician.
- Storage in or on the Range – Flammable materials should not be stored in an oven or near surface units.  
Do Not Use Water on Grease Fires- Smother fire or flame

## READ AND SAVE THESE INSTRUCTIONS

# RANGE SAFETY

or use dry chemical or foam-type extinguisher.

- Use Only Dry Potholders – Moist or damp potholders on hot surfaces may result in burns from steam. Do not let potholder touch hot heating elements. Do not use a towel or other bulky cloth.
- DO NOT TOUCH SURFACE UNITS OR AREAS NEAR UNITS – Surface units may be hot even though they are dark in color. Areas near surface units may become hot enough to cause burns. During and after use, do not touch, or let clothing or other flammable materials contact surface units or areas near units until they have had sufficient time to cool. Among those areas are the cooktop and surfaces facing the cooktop.
- Never Leave Surface Units Unattended at High Heat Settings – Boil over causes smoking and greasy spillovers that may ignite.
- Glazed Cooking Utensils – Only certain types of glass, glass/ceramic, ceramic, earthenware, or other glazed utensils are suitable for range-top service without breaking due to the sudden change in temperature.

- Utensil Handles Should Be Turned Inward and Not Extend Over Adjacent Surface Units – To reduce the risk of burns, ignition of flammable materials, and spillage due to unintentional contact with the utensil, the handle of a utensil should be positioned so that it is turned inward, and does not extend over adjacent surface units.
- Clean Cooktop With Caution – If a wet sponge or cloth is used to wipe spills on a hot cooking area, be careful to avoid steam burn. Some cleaners can produce noxious fumes if applied to a hot surface.
- Use Care When Opening Door – Let hot air or steam escape before removing or replacing food.
- Do Not Heat Unopened Food Containers – Build-up of pressure may cause container to burst and result in injury.
- Keep Oven Vent Ducts Unobstructed.
- Placement of Oven Racks – Always place oven racks in desired location while oven is cool. If rack must

**READ AND SAVE THESE INSTRUCTIONS**

# IMPORTANT SAFETY INSTRUCTIONS

be moved while oven is hot, do not let potholder contact hot heating element in oven.

- **DO NOT TOUCH HEATING ELEMENTS OR INTERIOR SURFACES OF OVEN** –Heating elements may be hot even though they are dark in color. Interior surfaces of an oven become hot enough to cause burns. During and after use, do not touch, or let clothing or other flammable materials contact heating elements or interior surfaces of oven until they have had sufficient time to cool. Other surfaces of the appliance may become hot enough to cause burns – among these surfaces are oven vent openings and surfaces near these openings, oven doors, and windows of oven doors.
- **Proper Installation** – The range, when installed, must be electrically grounded in accordance with local codes or, in the absence of local codes, with the National Electrical Code, ANSI/NFPA 70. In Canada, the range must be electrically grounded in accordance with Canadian Electrical Code. Be sure

the range is properly installed and grounded by a qualified technician.

- Disconnect the electrical supply before servicing the appliance.
- Injuries may result from the misuse of appliance doors or drawers such as stepping, leaning, or sitting on the doors or drawers.
- Maintenance – Keep range area clear and free from combustible materials, gasoline, and other flammable vapors and liquids.

## **For units with ventilating hood** –Clean Ventilating Hoods

- Frequently – Grease should not be allowed to accumulate on hood or filter.
- When flambé cooking under the vent hood, turn the fan on.

State of California Proposition 65 Warnings:

- **WARNING:** This product contains one or more chemicals known to the State of California to cause cancer.
- **WARNING:** This product contains one or more chemicals known to the State of California to cause birth defects or other reproductive harm.

## **READ AND SAVE THESE INSTRUCTIONS**

# PARTS AND FEATURES

## PARTS AND FEATURES

This manual covers several different models. The range you have purchased may have some or all of the items listed. The locations and appearances of the features shown here may not match those of your model.

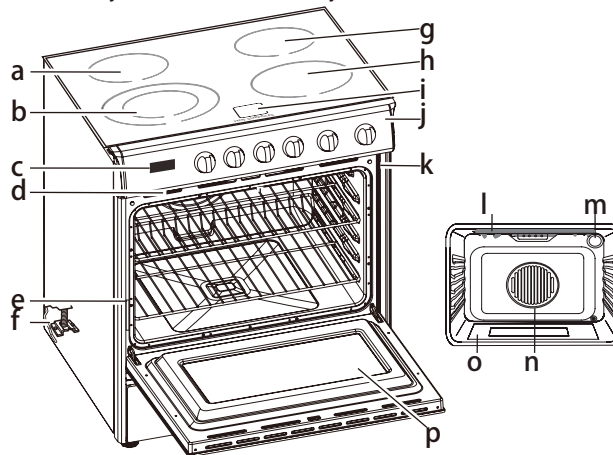

- a. Left Rear Surface Element
- b. Left Front Surface Element (Dual-element)
- c. Clock/Timer
- d. Oven Vent
- e. Model and Serial Number Plate
- f. Anti-tip Bracket
- g. Right Rear Surface Element
- h. Right Front Surface Element

- i. Hot Surface Indicator Lights
- j. Control Panel
- k. Door Gasket
- l. Broil Element
- m. Oven Light
- n. Convection Fan and Element
- o. Bottom Element (not visible)
- p. Oven Door Window



# CTRONIC CONTROL

## ELECTRONIC CONTROL

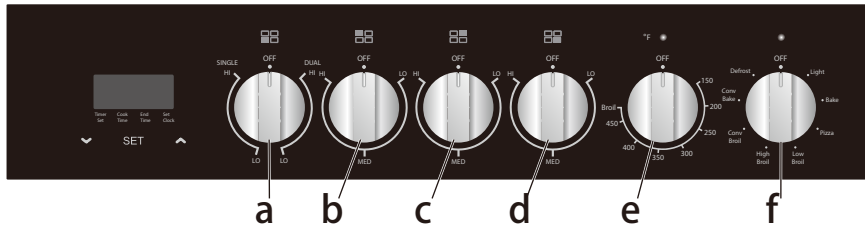

- a. Front Left Element
- b. Rear Left Element
- c. Rear Right Element
- d. Front Right Element
- e. Electric Oven Temperature Knob
- f. Electric Oven Control Knob

## SETTING THE CLOCK AND TIMER

Your model has a digital display, 12-hour clock with 3 Control buttons.

**IMPORTANT:** In the event of a power failure, all settings including the time display will be lost. When the power is returned, the bar above Timer Set and 12:00 will be displayed.

## TO SET THE TIME OF DAY

When the power is connected, the screen displays 12:00 and the bar above "Set Clock."

To set the correct time, press the up arrow or down arrow until the correct time is displayed. After 5 seconds, the clock will start automatically, or you can press the function button to select manual operation.

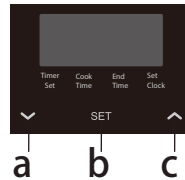

- a. Decrease Time
- b. Function
- c. Increase Time

## TO SET THE TIMER

The digital countdown timer can be set up to 11 hours and 59 minutes maximum.

To set the timer, press the function button repeatedly until the bar above Timer Set is displayed. Once the function button is released, the current time is displayed and the bar above Timer Set flashes. When the function button is pressed the remaining time is displayed. When the set time is reached, Timer Set disappears and the alarm will ring. To stop the alarm, press any button.

**NOTE:** After pressing the function button, you must set the timer within 5 seconds.

# ELEMENT AND CONTROL SETTING

## TIMED COOKING

### **WARNING**

#### **Food Poisoning Hazard**

Do not let food sit in oven more than one hour before or after cooking.

Doing so can result in food poisoning or sickness.

Timed Cooking allows the oven to be set to turn on at a certain time of day, cook for a set length of time, and/or shut off automatically. Delay start should not be used for food such as breads and cakes because they may not bake properly.

**NOTE:** Before setting, make sure the clock is set to the correct time of day. See “To Set the Time of Day” earlier in this section.

1. Press the function button repeatedly until the bar above Cook Time flashes and then press the up arrow or down arrow to set the time frame for baking.
2. Press the function button repeatedly until the bar above End Time flashes and then press the up arrow or down arrow to set the time to turn off the oven.
3. Set the cooking temperature and cooking mode by turning the Thermostat knob and the Selector knob.
4. After following these steps, the bars above Cook Time and End Time will flash, indicating that the automatic cooking feature of the oven is set.

For example: If cooking time takes 45 minutes and you want to finish cooking at 6:00.

1. Press the function button repeatedly until the bar above Cook Time flashes and set the cooking time 45 minutes.
2. Press the function button repeatedly until the bar above End Time flashes and set the finish time to 6:00.

After the above setting, the current time is displayed and the bars above Cook Time and End Time will flash indicating that the automatic cooking feature is set. When the clock displays 5:15, the oven will start cooking automatically, and the Cook Time bar will flash.

## ELEMENT AND CONTROL SETTING

### **WARNING**



#### **Fire Hazard**

Turn off all controls when done cooking.  
Failure to do so can result in death or fire.

The control knobs turn in either direction and from any position to the desired temperature setting or to OFF.

# ELEMENT AND CONTROL SETTING

## HEATING ELEMENTS

---

### TEMPERATURE LIMITERS

Each radiant element has its own temperature limiter (sensor) to protect the glass cooking surface from extreme high temperatures. The temperature limiter operates automatically by cycling the element to match the heat to the Temperature setting of the element (HI to LO).

### SINGLE RADIANT ELEMENT

This type of electric element uses a wire ribbon located under the glass surface to provide the heat for cooking. The temperature limiter will cycle the element on and off.

- Turn the knob from LO to HI temperature (or any temperature in between).

### DUAL RADIANT ELEMENT

The dual element consists of two radiant ribbon elements within the same element. Either the small (inner element) or both (inner and outer) elements may be selected for use. There are an infinite number of heat settings between the LO and HI position. Fixed positions are found at LO and HI to define minimum and maximum heat setting.

**To turn ON the inner element,** push down on the control knob and turn it counterclockwise following the single line graphics.

**To turn ON both inner and outer elements together,** push down on the control knob and turn clockwise following the double graphics line.

### HOT SURFACE INDICATOR LIGHT

Each element features a hot surface indicator light to show when the cooking area is ON or hot. The signal light will turn on automatically in the area marked with a circle.

The light remains on as long as the surface cooking area is too hot to touch even after the surface cooking area is turned off.

# ELEMENT AND CONTROL SETTING

## CONTROL KNOBS

The Control knobs turn in either direction and from any position to the desired temperature setting or to OFF.

**NOTE: Once the element is turned Off, the Hot Surface indicator light will remain illuminated until the surface temperature of the element has cooled.**

The placement of each knob corresponds to the placement of the heating element that it controls.

### To Turn On Any Heating Element:

- PUSH DOWN on the knob and TURN in either direction to desired heat setting.

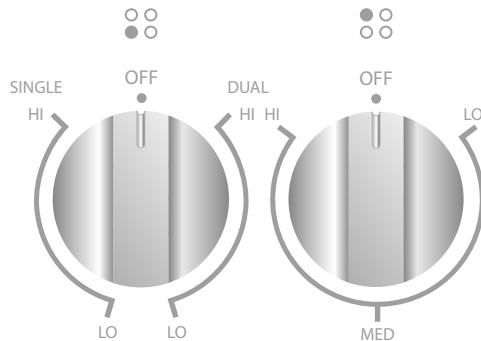

## RECOMMENDED HEATING ELEMENT SETTINGS

Heating elements do not require preheating. A range of heating settings is listed in the following chart because the required temperature depends on:

- Type and quality of pan
- Type, quantity and temperature of the food
- Element used and cook's preferences

TYPE OF FOOD	HEAT SETTINGS RADIANT ELEMENTS
	Energy regulator
Melting butter, chocolate	Low
Delicate sauce, rice, simmering sauces with butter and egg yolk	Low to Medium
Cooking vegetables, fish broths, eggs-fried or scrambled-,pasta, milk, pancakes, pudding, simmering meats, steaming vegetables, pop corn, bacon, stewing meat soup, sauteed vegetables, spaghetti sauces	Medium
Braising meat, pan frying meat, fish, eggs, stir frying, quickly brown or sear meats, hold rapid boil	Medium to High
Boiling water for vegetables, pasta	High

# COOKTOP USE

## COOKTOP USE

### BEFORE USING THE COOKTOP

1. If present, remove all packing and literature from the cooktop surface.
2. Clean your glass top. A thorough cleaning with a glass top cleaner is recommended. It only takes a minute and puts a clean, shiny coating on the glass top before its initial use.
3. Place a saucepan of water on each of the front elements and turn them on HI heat for at least 30 minutes. Turn off the front elements.
4. Place a saucepan of water on each of the rear elements and turn them on HI heat for at least 30 minutes. Turn off the rear elements.

#### NOTES:

- This procedure evaporates any protective oils and humidity collected during the manufacturing process, and enables the electronic control circuits to operate properly.
- There may be a slight odor during the first several users: this is normal and will dissipate.
- The cooking surface will hold the heat and remain hot over 20 minutes after the elements have been turned off.

## COOKWARE

The choice of pan directly affects the cooking performance (speed and uniformity). For best results, select pans with the following features.

### GENERAL

- The glass ceramic cooking surface is a durable material resistant to impact, but not unbreakable if a pan or other object is dropped on it.
- Do not allow pans to boil dry. This can damage the pan, element and /or cooktop.
- Never cook food directly on the glass.
- Do not slide cookware across cooking surface it may scratch the glass
- Using cast iron cookware on the glass cooktop is not recommended. Cast iron retains heat and may result in cooktop damage.
- Food packaged in aluminum foil should not be placed directly on the glass ceramic surface for cooking; aluminum foil will melt and cause permanent damage to the glass surface.

### Flat Base

When a pan is hot, the base (pan bottom) should rest evenly on the surface without wobbling (rocking). Ideal cookware should have a flat bottom, straight sides, a well fitting lid and the material should be of medium to heavy thickness.

Rough finishes may scratch the cooktop.

# COOKTOP USE

## Match Pan Diameter to Element

The base of the pan should cover or match the diameter of the element being used.

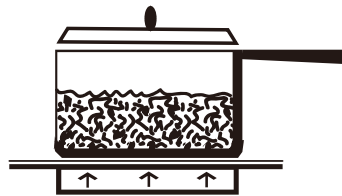

BALANCED PAN

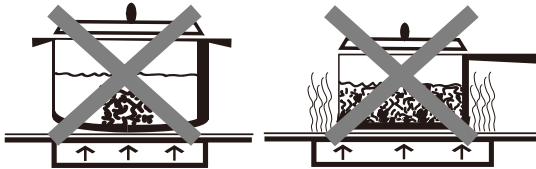

UNBALANCED PAN

## COOKWARE CHARACTERISTICS

- **Aluminum:** heats and cools quickly. Frying, braising, roasting. May leave metal markings on glass.
- **Cast Iron:** on a glass cooktop heats and cools slowly, but retains heat and cooks evenly. Not recommended.
- **Copper:** heats and cools quickly. Gourmet cooking, wine sauces, egg dishes.

- **Enamel ware:** response depends on base metal. Not recommended. Imperfections in enamel may scratch cooktop.
- **Glass Ceramic:** heats and cools slowly. Not recommended. Heats too slowly. Imperfections in enamel may scratch cooktop.
- **Stainless Steel:** heats and cools moderately. Soups, sauces, vegetables, and general cooking.

## OBSERVE THE FOLLOWING POINTS IN CANNING

### ⚠ CAUTION

#### Food Poisoning Hazard

Safe canning requires that harmful micro organisms are destroyed and that the jars are sealed completely. When canning foods in a water-bath canner, a gentle but steady boil must be maintained for the required time. When canning foods in a pressure canner, the pressure must be maintained for the required time.

After you have adjusted the controls, it is very important to make sure the prescribed boil or pressure levels are maintained for the required time.

Failure to do so can result in food poisoning or sickness.



# COOKTOP USE

Pots that extend beyond one of the surface unit's circle are not recommended for most surface cooking. However, when canning with water-bath or pressure canner, larger-diameter pots may be used.

This is because boiling water temperatures (even under pressure) are not harmful to the cooktop surfaces surrounding the surface units.

**However, do not use large diameter canners or other large-diameter pots for frying or boiling foods other than water.**

Most syrup or sauce mixtures, and all types of frying, cook at temperatures much higher than boiling water. Such temperatures could eventually harm the glass cooktop surfaces.

- Be sure the canner fits over the center of the surface unit. If your cooktop or its location does not allow the canner to be centered on the surface unit, use smaller diameter pots for good canning results.
- Flat-bottomed canners must be used. Do not use canners with flanged or rippled bottoms (often found in enamelware) because they don't make enough contact with the surface units and take a long time to boil water.
- When canning, use recipes and procedures from reputable sources. Reliable recipes and procedures are available from the manufacturer of your canner; manufacturers of glass jars for canning; and the United States Department of Agriculture Extension Service.

- Remember that canning is a process that generates large amounts of steam. To avoid burns from steam or heat, be careful when canning.

Since you must make sure to process the canning jars for the prescribed time, with no interruption in processing time, do not can on any cooktop surface unit if your canner is not flat.

# OVEN USE

---

# OVEN USE

## To Remove the Oven Shelf Support:

- Push down on the wire below the locking pin, and pull the support away from the oven wall until the top of the support is released from the holes in the oven wall.

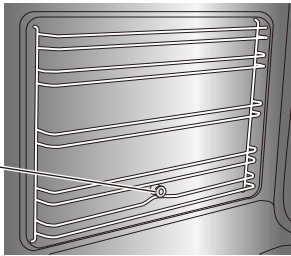

a.Locking Pin

## OVEN MODES

The Thermostat knob and Control knob are used together to select Oven Modes.

### THERMOSTAT KNOB

Select the cooking temperature by turning the knob clockwise to the required temperature, between 150 °F and Broil. The light will come on when the oven is preheating. The light will turn off when the desired temperature has been reached. Regular flashing means that oven temperature is being constantly maintained at the set temperature.

## COOKING MODE SELECTION KNOB

Selects the oven function. Each of the functions listed below can be used only with the correct temperature.

### Light

The oven light is off, with no cooking mode selected. During oven operation the light will remain on.

### Bake

Set temperature: from 150°F to 450°F

Is cooking with heated air. Both the upper and lower elements cycle to maintain the oven temperature.

### Pizza

Set temperature: from 150 °F to 450 °F

Is a special cooking mode with heated air and the lower hidden bake element. The lower elements cycle to cook Pizza.

### Low Broil

Set temperature: Broil

There are two broil elements. In low broil the inner and outer elements are on at a low intensity.

### High Broil

Set temperature: Broil

There are two broil elements. In high broil only the inner element is on at a high intensity.

# OVEN USE

## Conv Broil (Convection Broil)

Set temperature: Broil

Convection Broil combines the intense heat from the upper element with the heat circulated by the convection fan.

## Conv Bake (Convection Bake)

Set temperature: from 150 °F to 450 °F

Convection Bake cooks with heat from a ring element behind the back wall of the oven. The heat is circulated throughout the oven by the convection fan.

## Defrost

Set temperature: Not applicable.

Does not use any heating element, only the convection fan is used to defrost foods. By using Defrost mode, the defrosting time is decreased by half.

## BAKE TIPS AND TECHNIQUES

Baking is cooking with heated air. Both upper and lower elements in the oven are used to heat the air but no fan is used to circulate the heat.

Follow the recipe or convenience food directions for baking temperature, time and rack position. Baking time will vary with the temperature of ingredients and the size, shape and finish of the baking utensil.

## General Guidelines

- For best results, bake food on a single rack with at least 1" - 1 1/2" (2,5 - 3 cm) space between utensils and oven walls.
- Use one rack when selecting the bake mode.
- Check for doneness at the minimum time.
- Use metal bake ware (with or without a non stick finish), heatproof glass, glass-ceramic, pottery or other utensils suitable for the oven.
- When using heatproof glass, reduce temperature by 2 5°F (15°C) from recommended temperature.
- Use baking sheets with or without sides or jelly roll pans.
- Dark metal pans or nonstick coatings will cook faster with more browning. Insulated bake ware will slightly lengthen the cooking time for most foods.
- Do not use aluminum foil or disposable aluminum trays to line any part of the oven. Foil is an excellent heat insulator and heat will be trapped beneath it. This will alter the cooking performance and will damage the finish of the oven.
- Avoid using the opened door as a shelf to place pans.
- See Troubleshooting for tips to Solving Baking and Roasting Problems.

# OVEN USE

## BAKE CHART

FOOD ITEM	RACK POSITION	TEMP. °F (°C) (PREHEATED OVEN)	TIME (MIN)
Cake			
Cupcakes	2	350 (175)	19-22
Bundt Cake	1	350 (175)	40-45
Angel Food	1	350 (175)	35-39
Pie			
2 crust, fresh, 9"	2	375-400 (190-205)	45-50
2 crust, frozen fruit, 9"	2	375 (190)	68-78
Cookies			
Sugar	2	350-375 (175-190)	8-10
Chocolate Chip	2	350-375 (175-190)	8-13
Brownies	2	350 (175)	29-36
Breads			
Yeast bread loaf, 9x5	2	375 (190)	18-22
Yeast rolls	2	375-400 (190-205)	12-15
Biscuits	2	375-400 (190-205)	7-9
Muffins	2	425 (220)	15-19
Pizza			
Frozen	2	400-450 (205-235)	23-26
Fresh	2	475 (246)	15-18

## CONVECTION BAKE TIPS AND TECHNIQUES

Reduce recipe baking temperatures by 25°F (15°C).

- For best results, foods should be cooked uncovered, in low-sided pans to take advantage of the forced air circulation. Use shiny aluminum pans for best results unless otherwise specified.
- Heatproof glass or ceramic can be used. Reduce temperature by another 25°F (15°C) when using heatproof glass dishes for a total reduction of 50°F (30°C).
- Dark metal pans may be used. Note that food may brown faster when using dark metal bake ware.
- The number of racks used is determined by the height of the food to be cooked.
- Baked items, for the most part, cook extremely well in convection. Don't try to convert recipes such as custards, quiches, pumpkin pie, or cheesecakes, which do not benefit from the convection-heating process. Use the regular Bake mode for these foods.
- Multiple rack cooking for oven meals is done on rack position 1,2,3,4 and 5. All five rack positions can be used for cookies, biscuits and appetizers.
  - 2 Rack baking: Use positions 1 and 3.
  - When baking four cake layers at the same time, stagger pans so that one pan is not directly above another. For best results, place cakes on front of upper rack and back of lower rack (See graphic at right). Allow 1" - 1 1/2" (2,5 cm - 3 cm) air space around pans.

# OVEN USE

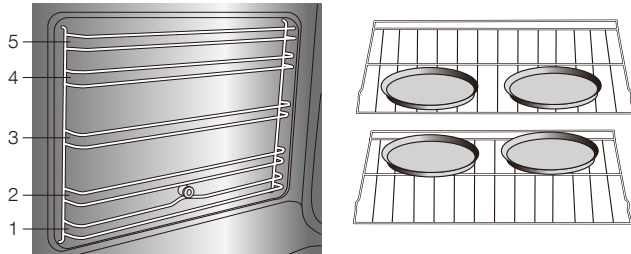

- Converting your own recipe can be easy. Choose a recipe that will work well in convection.
- Reduce the temperature and cooking time if necessary. It may take some trial and error to achieve a perfect result. Keep track of your technique for the next time you want to prepare the recipe using convection.
- See Troubleshooting for “Baking and Roasting Problems.”

## FOODS RECOMMENDED FOR CONVECTION BAKE MODE:

Appetizers Biscuits Coffee Cakes  
 Cookies (2 to 4 racks) Yeast Breads  
 Cream Puffs  
 Popovers  
 Casseroles and One-Dish Entrées  
 Oven Meals (rack positions 1, 2, 3)  
 Air Leavened Foods (Soufflés, Meringue, Meringue\_Topped Desserts, Angel Food Cake, Chiffon Cakes)

## CONVECTION BAKE CHART

Reduce standard recipe temperature by 25 °F (15 °C) for Convection Bake. Temperatures have been reduced in this chart.

### CONVECTION CAVITY

FOOD ITEM	RACK POSITION	TEMP. °F (°C) (PREHEATED OVEN)	TIME (MIN)
Cake			
Cupcakes	2	325 (160)	20-22
Bundt Cake	1	325 (160)	43-50
Angel Food	1	325 (160)	43-47
Pie			
2 crust, fresh, 9"	2	350-400 (175-205)	40-52
2 crust, frozen fruit, 9"	2	350 (175)	68-78
Cookies			
Sugar	2	325-350 (160-175)	9-12
Chocolate Chip	2	325-350 (160-175)	8-13
Brownies	2	325 (160)	29-36
Breads			
Yeast bread loaf, 9x5	2	350 (175)	18-22
Yeast rolls	2	350-375 (175-190)	12-15
Biscuits	2	375 (190)	8-10
Muffins	2	400 (205)	17-21
Pizza			
Frozen	2	375-425 (190-220)	23-26
Fresh	2	450 (232)	15-18



## CONVECTION ROAST TIPS AND TECHNIQUES

- Do not preheat for Convection Roast.
- Roast in a low-sided, uncovered pan.
- When roasting whole chickens or turkey, tuck wings behind back and loosely tie legs with kitchen string.
- Use the 2-piece broil pan for roasting uncovered.
- Use the probe or a meat thermometer to determine the internal doneness on “END” temperature (see cooking chart).
- Double-check the internal temperature of meat or poultry by inserting meat thermometer into another position.
- Large poultry may need to be covered with foil (and pan roasted) during a portion of the roasting time to prevent over-browning.
- After removing the food from the oven, cover loosely with foil for 10 to 15 minutes before carving, if necessary, to increase the final foodstuff temperature by 5° to 10°F (3° to 6° C).

## QUICK AND EASY RECIPE TIPS

Converting from standard BAKE to CONVECTION ROAST:

- Temperature does not have to be lowered.
- Roasts, large cuts of meat and poultry generally take 10-20% less cooking time. Check doneness early.
- Casseroles or pot roasts that are baked covered in CONVECTION ROAST will cook in about the same amount of time.

## CONVECTION ROAST CHART

### CONVECTION CAVITY

# OVEN USE

MEATS	WEIGHT (lb)	OVEN TEMP. °F (°C)	RACK POSITION	TIME (min. per lb)	INTERNAL TEMP. °F (°C)
<b>Beef</b>					
Rib Roast	4-6	325 (160)	2	16-20	145 (63) medium rare
				18-22	160 (71) medium
Rib Eye Roast, (boneless)	4-6	325 (160)	2	16-20	145 (63) medium rare
				18-22	160 (71) medium
Rump, Eye, Tip, Sirloin (boneless)	3-6	325 (160)	2	16-20	145 (63) medium rare
				18-22	160 (71) medium
Tenderloin Roast	2-3	400 (205)	2	15-20	145 (63) medium rare
<b>Pork</b>					
Loin Roast (boneless or bone-in)	5-8	350 (175)	2	16-20	160 (71) medium
Shoulder	3-6	350 (175)	2	20-25	160 (71) medium
<b>Poultry</b>					
Chicken whole	3-4	375 (190)	2	18-21	180 (82)
Turkey, not stuffed	12-15	325 (160)	1	10-14	180 (82)
Turkey, not stuffed	16-20	325 (160)	1	9-11	180 (82)
Turkey, not stuffed	21-25	325 (160)	1	6-10	180 (82)
Turkey Breast	3-8	325 (160)	1	15-20	170 (77)
Comish Hen	1-1 1/2	350 (175)	2	45-75 total	180 (82)
<b>Lamb</b>					
Half Leg	3-4	325 (160)	2	22-27	160 (71) medium
				28-33	170 (77) well
Whole Leg	6-8	325 (160)	1	22-27	160 (71) medium
				28-33	170 (77) well

## CONVECTION BROIL TIPS AND TECHNIQUES

- Place rack in the required position needed before turning on the oven.
- Use Convection Broil mode with the oven door closed.
- Do not preheat oven.
- Use the 2-piece broil pan.
- Turn meats once halfway through the cooking time (see convection broil chart).
- Thicker cuts and unevenly shaped pieces of meat, fish and poultry may cook better at lower broiling temperatures.

# RANGE CARE

## CONVECTION BROIL CHART

### CONVECTION CAVITY

FOOD AND THICKNESS	RACK POSITION	BROIL SETTING	INTERNAL TEMP. °F (°C)	TIME SIDE 1 (MIN.)*	TIME SIDE 2 (MIN.)*
<b>Beef</b>					
Steak (1-1/2" or more)					
Medium rare	4	Low	145 (65)	9-12	8-10
Medium	4	Low	160 (71)	11-13	10-12
Well	4	Low	170 (77)	18-20	16-17
Hamburgers (more than 1")					
Medium	4	High	160 (71)	8-11	5-7
Well	4	High	170 (77)	11-13	8-10
<b>Poultry</b>					
Chicken Quarters	4	Low	180 (82)	16-18	10-13
Chicken Halves	3	Low	180 (82)	25-27	15-18
Chicken Breasts	4	Low	170 (77)	13-15	9-13
<b>Pork</b>					
Pork Chops (1 1/4" or more)	4	Low	160 (71)	12-14	11-13
Sausage - fresh	4	Low	160 (71)	4-6	3-5

## RANGE CARE

### CLEANING

**IMPORTANT:** Before cleaning, make sure all controls are off and the oven and cooktop are cool. Always follow label instructions on cleaning products. Soap, water and a soft cloth or sponge are suggested first unless otherwise noted. Do not use abrasive cleaning products.

### EXTERIOR PORCELAIN ENAMEL SURFACES

Food spills containing acids, such as vinegar and tomato, should be cleaned as soon as the entire appliance is cool. These spills may affect the finish.

#### Cleaning Method:

Glass cleaner, mild liquid cleaner or nonabrasive scrubbing pad: Gently clean around the model and serial number plate because scrubbing may remove numbers.

### EXTERIOR STAINLESS STEEL

**NOTE:** Do not use soap-filled scouring pads, abrasive cleaners, Cooktop Polishing Cream, steel-wool pads, gritty washcloths or some paper towels. Damage may occur, even with one-time or limited use.

Rub in direction of grain to avoid damaging.

# RANGE CARE

## Cleaning Methods:

Liquid detergent or all-purpose cleaner: Rinse well with clean water and dry with soft, lint-free cloth.

Stainless Steel Cleaner and Polish

Vinegar for hard water spots

## OVEN DOOR EXTERIOR

### Cleaning Method:

Glass cleaner and paper towels or nonabrasive plastic scrubbing pad: Apply glass cleaner to soft cloth or sponge, not directly on panel.

## RADIANT COOKTOP

The ceramic glass should be cleaned regularly, preferably after each use, as soon as the Hot Surface warnings have turned off.

Remove any burned residues immediately after cooking.

### Cleaning Method:

Rinse with water and dry with a clean, soft cloth. Apply a glass cooktop cleaner. Use a damp cloth and dry with a paper towel.

**NOTE:** Do not use abrasive or corrosive detergents, cleansers, oven sprays, spot removers, or steel-wool scouring pads.

## SMUDGES FROM PANS WITH AN ALUMINUM BOTTOM

### Cleaning Method:

A cloth dampened in vinegar.

## COOKTOP CONTROL KNOBS

- Pull knobs straight away from control panel to remove.
- When replacing knobs, make sure knobs are in the Off position.

### Cleaning Method:

Soap and water or dishwasher:

**NOTE:** Do not use steel wool, abrasive cleansers or oven cleaner. Do not soak knobs.

## CONTROL PANEL

### Cleaning Method:

Glass cleaner and soft cloth or sponge: Apply glass cleaner to soft cloth or sponge, not directly on panel.

**NOTE:** Do not use abrasive cleaners, steel-wool pads, gritty washcloths or some paper towels. Damage may occur.

## OVEN CAVITY

Food spills should be cleaned when oven cools. At high temperatures, foods react with porcelain, so staining, etching, pitting or faint white spots can result.

# OVEN DOOR REMOVAL

## Cleaning Method:

Mild detergent and warm water.

**NOTE:** Do not use oven cleaners.

## OVEN RACKS AND ROASTING RACKS

### Cleaning Method:

Steel-wool pad

## 2-PIECE BROILER PAN

### Cleaning Method:

Mildly abrasive cleanser: Scrub with wet scouring pad.

Solution of  $\frac{1}{2}$  cup (125 mL) ammonia to 1 gal. (3.75 L) water: Soak for 20 minutes, and then scrub with scouring or steel-wool pad.

Oven cleaner: Follow product label instructions.

Porcelain enamel only, not chrome.

Dishwasher: Place broiler pan in dishwasher.

# OVEN DOOR REMOVAL

The oven door weighs 30 lbs (14kg). For ease of installation and more thorough cleaning, some oven doors may be removed.

## IMPORTANT:

- There are two styles of oven door, so first identify the style of your oven door.

- Make sure oven is cool and power to the oven has been turned off before removing the door.
- The oven door is heavy and fragile, and the door front is glass. To avoid oven door glass breakage, use both hands, and grasp only the sides of the oven door to remove.
- Be sure that both levers are securely in place before removing the door.
- Do not force door open or closed.

### Style 1 -

#### To remove the oven door:

1. Open the door fully.

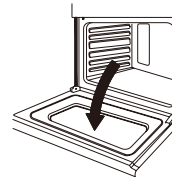

2. Lift up and turn the small levers situated on the two hinges.

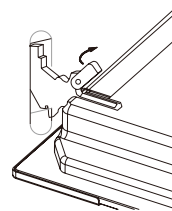

# OVEN DOOR REMOVAL

3. Grasp the door by its two outer edges, and then close it slowly but not completely.
4. Pull the door toward you, pulling it out of the hinge receivers located in the frame.

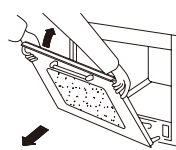

5. Replace the door by reversing the previous steps.

## Style 2 -

### To remove the oven door:

1. Open the door fully.

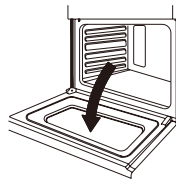

2. Push down and turn the small levers situated on the two hinges.
3. Grasp the door by its two outer edges, and then close it slowly but not completely.
4. Unlock the door by pressing on the clamps.

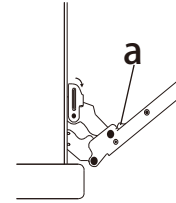

**a** Clamps

5. Pull the door toward you, pulling it out of the hinge receivers located in the frame.

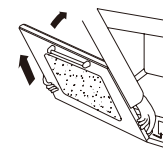

6. Replace the door by reversing the previous steps.



# OVEN DOOR REMOVAL

## REPLACING AN OVEN LIGHT

### ⚠ WARNING



#### Electrical Shock Hazard

Make sure the oven and lights are cool and power to the oven has been turned off before replacing the light bulb(s).

The lenses must be in place when using the oven.

The lenses serve to protect the light bulb from breaking.

The lenses are made of glass. Handle carefully to avoid breakage.

Failure to do so could result in death, electric shock, cuts or burns.

**IMPORTANT:** The light bulb in your oven is Type: E 14, 220-240V and 25W. You must replace this bulb with an appliance bulb of the same type, voltage and wattage.

#### To Replace the Light Bulb:

1. Make sure oven is turned Off and cool.

2. Disconnect power at the main power supply (fuse or breaker box).

3. Unscrew the lens and remove.

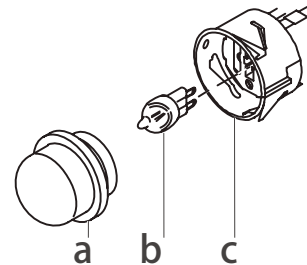

a. Lens

b. Bulb

c. Socket

4. Pull the burned-out bulb from the socket, and then replace it with an appliance bulb of the same type, voltage and wattage.

5. Replace the lens.

6. Turn on power at the main power supply (fuse or breaker box).

# TROUBLESHOOTING

## TROUBLESHOOTING

### BAKING AND ROASTING PROBLEMS

With any oven setting poor results can occur for many reasons other than a malfunction of the oven. Check the chart below for causes of the most common problems. Since the size, shape and material of baking utensils directly affect the baking results, the best solution may be to replace old baking utensils that have darkened and warped with age and use.

BAKING PROBLEM	CAUSE
Food browns unevenly	Oven not preheated Aluminum foil on oven rack or oven bottom Baking utensil too large for recipe Pans touching each other or oven walls
Food too brown on bottom	Oven not preheated Using glass, dull or darkened metal pans Incorrect rack position Pans touching each other or oven walls
Food is dry or has shrunk excessively	Oven temperature too high Baking time too long Oven door opened frequently Pan size too large
Food is baking or roasting too slowly	Oven temperature too low Oven not preheated Oven door opened frequently Tightly sealed with aluminum foil Pan size too small

Piecrusts do not brown on bottom or crust is soggy	Baking time not long enough Using shiny steel pans Incorrect rack position Oven temperature is too low
Cakes pale, flat and may not be done inside	Oven temperature too low Incorrect baking time Cake tested too soon Oven door opened too often Pan size may be too large
Cakes high in middle with crack on top	Oven temperature too high Baking time too long Pans touching each other or oven walls Incorrect rack position Pan size too small
Piecrust edges too brown	Oven temperature too high Edges of crust too thin

# TROUBLESHOOTING

## COOKTOP

PROBLEM	POSSIBLE CAUSE	SOLUTION
<b>Heating elements and controls do not work.</b>	Fuse is blown or circuit breaker is tripped.  No electricity to the cooktop.	Replace the fuse or reset the circuit breaker. If the problem continues, call an electrician.  Have electrician check your power supply.
<b>Heating elements do not heat properly.</b>	Improper cookware is being used.	Select proper cookware. See "Cookware." If the problem continues, call for service.
<b>Heating elements cycle off even when elements are turned to their highest settings.</b>	Heating element temperature limiters are temporarily shutting <b>off the elements due to</b> exceeding the maximum allowable temperature.	This is a normal operating condition, especially during rapid heat-up operations. The element will cycle back on automatically after it has cooled sufficiently.
<b>Glass ceramic surface is see through or appears to be red in color.</b>	Under direct or bright lighting, you will sometimes be able to see through the glass and into the chassis due to its transparent quality. You may also notice a red tint under these conditions	These are normal properties of black ceramic glass panels.

## OVEN

# TROUBLESHOOTING

PROBLEM	POSSIBLE CAUSE	SOLUTION
<b>Oven is not heating</b>	No power to the oven	Replace the fuse or reset the circuit breaker. If the problem continues, call an electrician.
	Oven control not turned on	Make sure the oven temperature has been selected.
<b>Oven is not cooking evenly</b>	Not using the correct bake ware or oven rack position	Refer to cook charts for recommended rack position. Always reduce recipe temperature by 25 °F(15 °C) when baking with Convention Bake mode.
<b>Oven display stays off</b>	Power interruption	Turn off power at the main power supply (fuse or breaker box). Turn breaker back on. If condition persists, call for service.
<b>Cooling fan continues to run after oven is turned off</b>	The electronic components have not yet cooled sufficiently	The fan will turn off automatically when the electronic components have cooled sufficiently.
<b>Oven light is not working properly</b>	Light bulb loose or burned-out.	Reinsert or replace the light bulb. Touching the bulb with fingers may cause the bulb to burn out.
<b>Oven light stays on</b>	Door is not closing completely	Check for obstruction in oven door. Check to see if hinge is bent or door switch broken.
<b>Cannot remove lens cover</b>	Soil build-up around the lens cover.	Wipe lens cover area with a clean, dry towel prior to attempting to remove the lens cover.
<b>Clock and timer are not working properly</b>	No power to the oven	Check the circuit breaker or fuse box to your house. Make sure there is proper electrical power to the oven.
<b>Excessive Moisture</b>		When using bake mode, preheat the oven first. Convection Bake and Convection Roast will eliminate any moisture in the oven.
<b>Porcelain Chips</b>	Porcelain interior is bumped by oven racks	When removing and replacing oven racks, always tilt racks upward and do not force them to avoid chipping the porcelain.

FOR MORE HELP, VISIT [GalanzAMERICA.COM](http://GalanzAMERICA.COM) OR CALL THE CONSUMER HELP LINE AT 1-877-337-3639.

# LIMITED WARRANTY

## IN-HOME SERVICE FULL ONE YEAR WARRANTY

For 12 months from the date of original retail purchase, Galanz will repair or replace any part free of charge including labor that fails due to a defect in materials or workmanship. Galanz may replace or repair at their sole discretion any part, or sub system including the entire product. Product must be accessible, without encumbrance and installed properly to receive warranty repair service.

## LIMITED WARRANTY

**NOTE:** This warranty commences on the date the item was purchased, or ownership assumed from a builder and the original purchase receipt must be presented to the authorized service representative before warranty repairs are rendered.

### Exceptions:Commercial Use Warranty

**90 days labor from date of original purchase**

**90 days parts from date of original purchase**

**No other warranty applies.**

## FOR WARRANTY SERVICE

All service must be performed by a Galanz authorized service . For service, please call 1-800-562-0738. Before calling please have available the following information: (a) Model number and serial number of your appliance. (b) The name and address of the dealer you purchased the unit from and the date of purchase. (c) A clear description of the problem. (d) A proof of purchase (sales receipt).

**This warranty covers home appliance services within the contiguous United States and where available in Alaska, Hawaii and Puerto Rico.**

### What is not covered by this warranty:

Replacement or repair of household fuses, circuit breakers, wiring or plumbing. A product whose original serial number has been removed or altered. Any service charges not specifically identified as normal such as normal service area or hours.

Replacement of light bulbs.

Damage to clothing.

Damage incurred in shipping.

Damage caused by improper installation or maintenance.

Damage from misuse, abuse accident, fire, flood, or acts of nature.

Damage from service other than an authorized Galanz dealer or service center.

Damage from incorrect electrical current, voltage or supply.

Damage resulting from any product modification, alteration or adjustment not authorized by Galanz.

Adjustment of consumer operated controls as identified in the owner's manual.

Hoses, knobs, lint trays and all attachments, accessories and disposable parts.

Labor, service transportation, and shipping charges for the removal and replacement of defective parts beyond the initial 12-month period.

Damage from other than normal household use.

Any transportation and shipping charges.

**THIS LIMITED WARRANTY IS GIVEN IN LIEU OF ALL OTHER WARRANTIES, EXPRESS ED OR IMPLIED, INCLUDING BUT NOT LIMITED TO, THE WARRANTIES OF MERCHANTABILITY AND FITNESS FOR A PARTICULAR PURPOSE**

The remedy provided in this warranty is exclusive and is granted in lieu of all other remedies.

This warranty does not cover incidental or consequential damages, so the above limitations may not apply to you.

Some states do not allow limitations on how long an implied warranty lasts, so the above limitations may not apply to you.

This warranty gives you specific legal rights, and you may have other rights, which vary from state to state.

# WARRANTY REGISTRATION

Please mail this warranty card to the address below within 30 days of purchase.  
**Galanz Americas, 55 Challenger Road, Suite 503, Ridgefield Park, NJ 07660.**

**PLEASE PRINT CLEARLY.**

Name \_\_\_\_\_

Address \_\_\_\_\_

City \_\_\_\_\_ State \_\_\_\_\_ ZIP \_\_\_\_\_

Phone \_\_\_\_\_ Email \_\_\_\_\_

Model Number \_\_\_\_\_ Serial Number \_\_\_\_\_

Purchase Location \_\_\_\_\_

**You must attach a copy of your purchase receipt to validate your registration.**

# Galanz