

V3504

INSTALLATION MANUAL

ROUND POOLS

**ZENITH STR/RTR/LX
CAMILIA OHANA
SIMBIO VECTRA MAGNUS
MURANO SOVANNA
MAGNUS VECTRA**

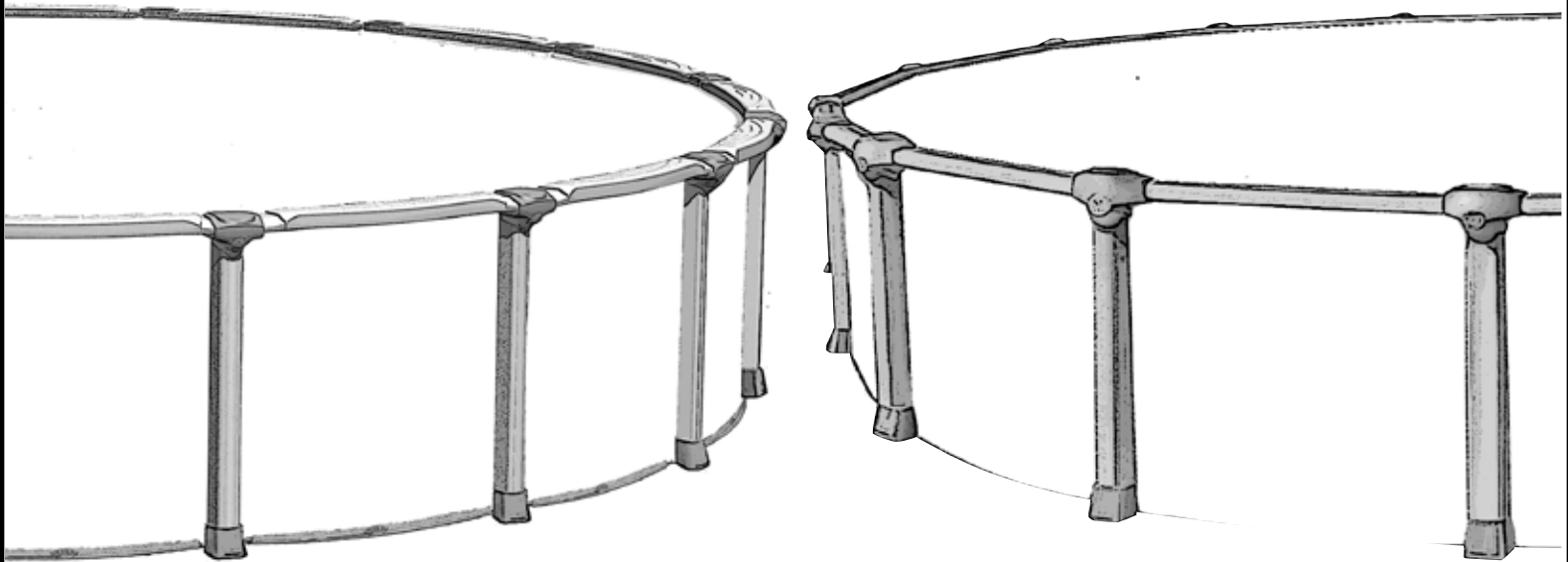



ABOVE GROUND POOL SAFETY

PLEASE READ BEFORE INSTALLATION



WARNING

FAILURE TO HEED THESE WARNINGS CAN RESULT IN PERMANENT INJURY, PARALYSIS FROM A BROKEN NECK, ELECTROCUTION OR DROWNING.

THIS POOL IS NOT DESIGNED FOR DIVING OR JUMPING!
DANGEROUS INJURY CAN RESULT. SHALLOW WATER!

Carefully read, understand and follow all information in this user manual before installing and using the swimming pool. These warnings, instructions and safety guidelines address some common risks of water recreation, but they cannot cover all risks and dangers in all cases. Always use caution, common sense and good judgment when enjoying any water activity. **RETAIN THIS INFORMATION FOR FUTURE USE.**

Your pool contains a large quantity of water, and is deep enough to present inherent dangers to life and health unless the following safety rules are strictly observed. First-time users run the highest risk of injury. Make sure everyone understands and encourage all users especially children to learn how to swim. Learn Basic Life Support (Cardiopulmonary Resuscitation-CPR) and refresh this knowledge regularly. Instruct all pool users, including children, what to do in case of an emergency. Keep a working phone and a list of emergency phone numbers near the pool. This can make a life-saving difference in the event of an emergency. To ensure your pool is used safely you **MUST** observe the following safety precautions:

1. NO JUMPING OR DIVING

The top rail of your pool is not a walkway and must not be used for jumping or diving. Do not permit jumping or diving into the pool from a deck or the top rail of the pool. Diving or jumping into the pool can result in serious injury.

2. NEVER USE THE POOL ALONE

Never permit the pool to be used unless it is attended by at least one person other than the bather. Someone should always be available to lend assistance in an emergency. Designate a competent adult to supervise the pool each time it is being used. Vigilant supervision of weak swimmers and non-swimmers by a competent adult is required at all times, remembering that children under five are at the highest risk of drowning.

3. NEVER LEAVE CHILDREN UNATTENDED

Never leave a child alone and unsupervised in or near the pool—not even for a second. There is no substitute for constant adult supervision.

4. NO ROUGH PLAY

Do not permit "roughhousing" in and around your pool. Surfaces can become slippery and hazardous when wet.

5. LIGHT THE POOL AT NIGHT

If the pool is used after dusk, adequate lighting must be provided. Illumination in the pool area must be sufficient to clearly judge pool depth and all features in and around the pool. For lighting recommendations, consult your local licensed electrical contractor

6. RESTRICT ACCESS TO THE POOL

Do not leave chairs or other furniture beside the pool that could be used by a child to climb up into the pool. Ladders must be removed whenever the pool is unattended. A fence with a lockable gate around the pool or yard is strongly recommended and may be required by law in some jurisdictions. Secure doors and windows, where applicable to prevent unauthorized access to the swimming pool. Remove all toys from the swimming pool and surrounding area when not in use to avoid attracting children to the pool. Barriers, pool covers, pool alarms or similar safety devices are helpful aids, but they are not substitutes for continuous adult supervision.

7. NO ALCOHOL OR DRUGS

Never drink alcoholic beverages, use any intoxicants or medication which could hinder your judgment and reflexes.

8. KEEP YOUR POOL CLEAN AND SANITARY

Your filter system will remove suspended particles from the water and the surface skimmer will remove insects, leaves and other debris from the water surface. Use the correct pool chemicals as directed to destroy harmful bacteria and prevent formation of algae. Remember, unsanitary water is a serious health hazard.

9. KEEP OFF TOP LEDGES

Do not walk on top ledges. They can be slippery and they are not a walkway.

10. POOL COVER SAFETY

The cover must have a tamperproof locking retainer cable that positions the cover around the pool wall and keeps it securely in place. Never allow anyone, especially small children on the cover. Asphyxiation or drowning could result. Be sure to remove pool cover completely from the water surface before entering the pool. When purchasing any pool cover, please consult a swimming pool professional.

11. ELECTRICAL HAZARD

Never touch or attempt to service electrical equipment, including the filter when your body and/or the ground is wet. Electrocution or permanent injury due to high voltage (120V AC) could result. The pool should be bonded in accordance with Section 680-26 of the National Electrical Code. For further assistance contact your dealer or a local licensed electrician. Do not use pool during electrical or rain storms.

12. SAFETY EQUIPMENT

Keep a safety rope 1/4" by 50" with a flotation buoy with an outside diameter of 15". Have accessible in a prominent area by your pool. Keep a pole not less than 16 feet (4,88m) long with a blunt or hook end available at poolside in case of emergencies. Weak swimmers and non-swimmers should wear personal protection equipment when using the pool.

13. POOL CHEMICALS

Store pool chemicals out of the reach of children. Do not place chlorine, chlorine tablets or sticks directly into skimmer, or winterize your pool with liquid chlorine. Damage to the skimmer, pool liner and filter will result. Failure to obey this instruction will void all component warranties. Always follow chemical manufacturer's instructions when storing, handling and dispensing pool chemicals.

14. CHECK FOR DAMAGE

Periodically check your pool and ladder components for damage and wear. Be sure all screws are in place. Replace all damaged or worn components and tighten all screws before you use the pool, deck or ladders. At first sign, remove rust and touch up immediately.

15. POOL PARTS

Never modify the pool or accessories, or remove or drill holes in the pool, deck or ladder components unless instructed. Your pool wall is made of thin metal, there is an inherent cut hazard with metal so use gloves during installation. Always use Original Equipment Manufactured parts for your replacement parts.

FOLLOW ALL SAFETY INSTRUCTIONS

Read and follow all safety instructions packaged with pool, ladder, deck or any other accessory. Additional pool safety publications can be obtained by contacting: The Association of Pool & Spa Professionals (www.apsp.org)



IMPORTANT NOTICE READ BEFORE INSTALLATION!

The safety stickers must be installed as per following instructions. Failure to properly install warning labels will void warranty. Failure to mount these safety labels may subject you to substantial liability in case of injury. These warnings are not to be removed under any circumstances! If they become discolored or fall off please request replacements which will be sent at no charge.

PLACE SIGN ON LINER ABOVE WATER LINE, OPPOSITE ENTRY TO POOL



PLACESIGNON WALL NEXT TO POOL ENTRY



REMEMBER WATCH CHILDREN



IMPORTANT INFORMATION ABOUT YOUR LINER

We do not make or supply liners for our pools.

Please contact your liner's manufacturer with questions or if instructions are not included with the liner.

Liner must be installed per the liner manufacturer's instructions.

Incorrect liner installation may void the warranty.

Section
1

GENERAL INSTRUCTIONS - ROUND POOLS
GROUND PREPARATION

PARTS LISTING - EXPLODED VIEW

Zenith STR
PZEN-52SSPSPSB10
Round

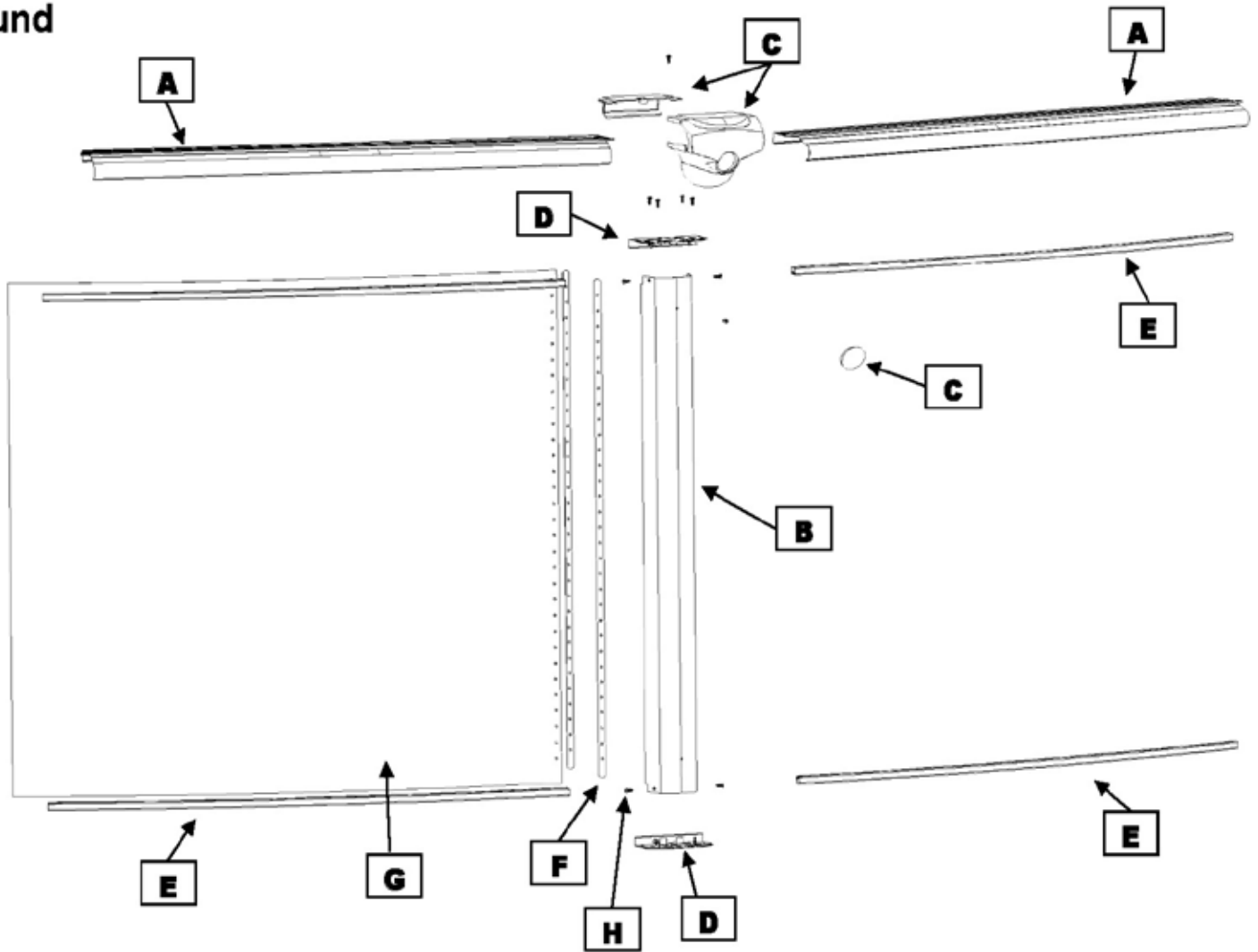

**Section
1**

**GENERAL INSTRUCTIONS - ROUND POOLS
GROUND PREPARATION**

PARTS LISTING - CONTENT

Product Description:		Zenith Round		Revised Sept 2018							
Product Code :		PZEN-52SSPSPSB10		Quantity required for installation (by pool size)							
Index #	Description	Part #	8	12	15	18	21	24	27	30	33
A	Top ledge 30"	ART211-1295030	10								
A	Top ledge 50"	ART211-1295050		9							
A	Top ledge 52"	ART211-1295052			11	13					
A	Top ledge 53"	ART211-1295053					15	17	19	21	23
B	Upright (52)	ART711-R12954M	10	9	11	13	15	17	19	21	23
C	Ledge cover	AR211-23120ABC	10	9	11	13	15	17	19	21	23
D	Bottom/Top plate	21120A	20	18	22	26	30	34	38	42	46
E	Stabilizer/Bottom Rail	LA1254108	20								
E	Stabilizer/Bottom Rail	LA1254112		18							
E	Stabilizer/Bottom Rail	LA1254115			22						
E	Stabilizer/Bottom Rail	LA1254118				26					
E	Stabilizer/Bottom Rail	LA1254121					30				
E	Stabilizer/Bottom Rail	LA1254124						34			
E	Stabilizer/Bottom Rail	LA1254127							38		
E	Stabilizer/Bottom Rail	LA1255330								42	46
F	Steel bars	11823	2	2	2	2	2	2	2	2	2
G	Wall		1	1	1	1	1	1	1	1	1
H	Screw 12x3/4	V12x34	102	98	113	133	153	174	194	215	235
*	Hardware bag/pool	SACV12X34-102	1								
*	Hardware bag/pool	SACV12X34-98		1							
*	Hardware bag/pool	SACV12X34-113			1						
*	Hardware bag/pool	SACV12X34-133				1					
*	Hardware bag/pool	SACV12X34-153					1				
*	Hardware bag/pool	SACV12X34-174						1			
*	Hardware bag/pool	SACV12X34-194							1		
*	Hardware bag/pool	SACV12X34-215								1	
*	Hardware bag/pool	SACV12X34-235									1
**	Hardware bag/wall	1050000054	1	1	1	1	1	1	1	1	1
	Thrus phill 18-8 bolts 18-8 1/4-0x3/4	99-0023	31	31	31	31	31	31	31	31	31
	Flange nuts S/S 1/4-20 Serrated	2FGS422	31	31	31	31	31	31	31	31	31
	Instruction DVD	SACWBI36876	1	1	1	1	1	1	1	1	1

* In the hardware bag/pool you will find parts: #V12x34

** In the hardware bag/wall you will find parts: #99-0023 - 2FGS422

Section
1

GENERAL INSTRUCTIONS - ROUND POOLS
GROUND PREPARATION

PARTS LISTING - EXPLODED VIEW

Zenith STR
PZEN-52SSPSPSB19
Round

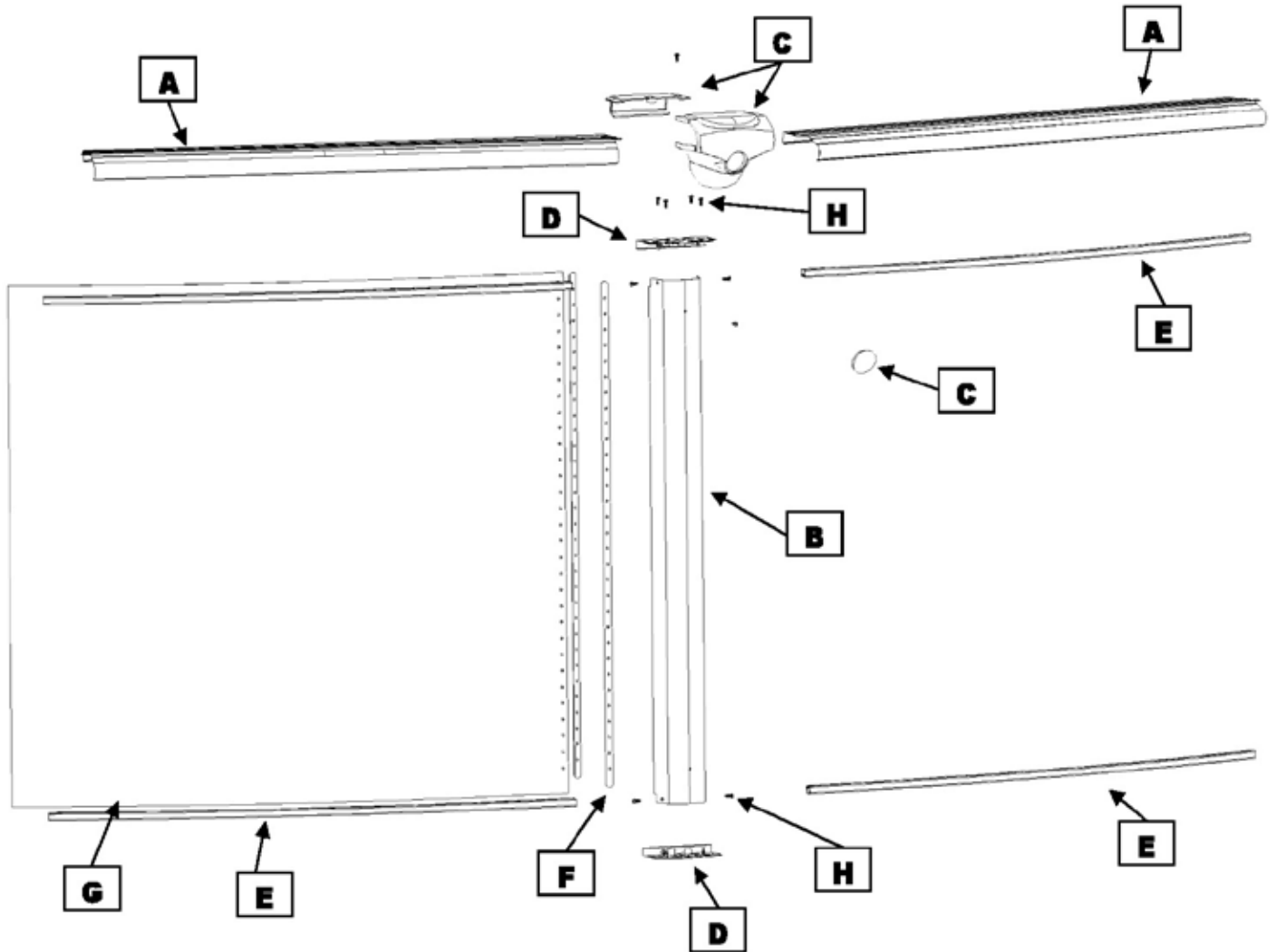

**Section
1**

**GENERAL INSTRUCTIONS - ROUND POOLS
GROUND PREPARATION**

PARTS LISTING - CONTENT

Product Description:		Zenith Round	Revised Sept 2018									
Product Code		PZEN-52SSPSPB19										
Index#	Description	Part #	Quantity required for installation (by pool size)									
			8	12	15	18	21	24	27	30		
A	Top ledge 30"	ART211-1295030	10									
A	Top ledge 50"	ART211-1295050		9								
A	Top ledge 52"	ART211-1295052			11	13						
A	Top ledge 53"	ART211-1295053						15	17	19	21	
B	Upright	ART711-R12954M	10	9	11	13	15	17	19	21		
C	Ledge cover	AR211-23120ABC	10	9	11	13	15	17	19	21		
D	Plate	21120A	20	18	22	26	30	34	38	42		
E	Stabilizer/Bottom rail	LA1254108	20									
E	Stabilizer/Bottom rail	LA1254112		18								
E	Stabilizer/Bottom rail	LA1254115			22							
E	Stabilizer/Bottom rail	LA1254118				26						
E	Stabilizer/Bottom rail	LA1254121					30					
E	Stabilizer/Bottom rail	LA1254124						34				
E	Stabilizer/Bottom rail	LA1254127							38			
E	Stabilizer/Bottom rail	LA1255330									42	
F	Steel bars	11823	2	2	2	2	2	2	2	2	2	2
G	Wall		1	1	1	1	1	1	1	1	1	1
H	Screw 12x3/4	V12x34	102	98	113	133	153	174	194	215		
*	Hardware bag/pool	SACV12X34-102	1									
*	Hardware bag/pool	SACV12X34-98		1								
*	Hardware bag/pool	SACV12X34-113			1							
*	Hardware bag/pool	SACV12X34-133				1						
*	Hardware bag/pool	SACV12X34-153					1					
*	Hardware bag/pool	SACV12X34-174						1				
*	Hardware bag/pool	SACV12X34-194							1			
*	Hardware bag/pool	SACV12X34-215								1		
**	Hardware bag/wall	1050000054	1	1	1	1	1	1	1	1	1	1
	Coping	10296	7	10	12	15	17	19	22	24		
	ThruSS phill 18-8 bolts 18-8 1/4-0x3/4	99-0023	31	31	31	31	31	31	31	31	31	31
	Flange nuts S/S 1/4-20 Serrated	2FGS422	31	31	31	31	31	31	31	31	31	31
	Instruction DVD	SACWBI36876	1	1	1	1	1	1	1	1	1	1

* In the hardware bag/pool you will find parts: #V12x34

** In the hardware bag/wall you will find parts: #99-0023 - 2FGS422

Section
1

GENERAL INSTRUCTIONS - ROUND POOLS
GROUND PREPARATION

PARTS LISTING - EXPLODED VIEW

Zenith STR
PZEN-54SSPSPSB10
Round

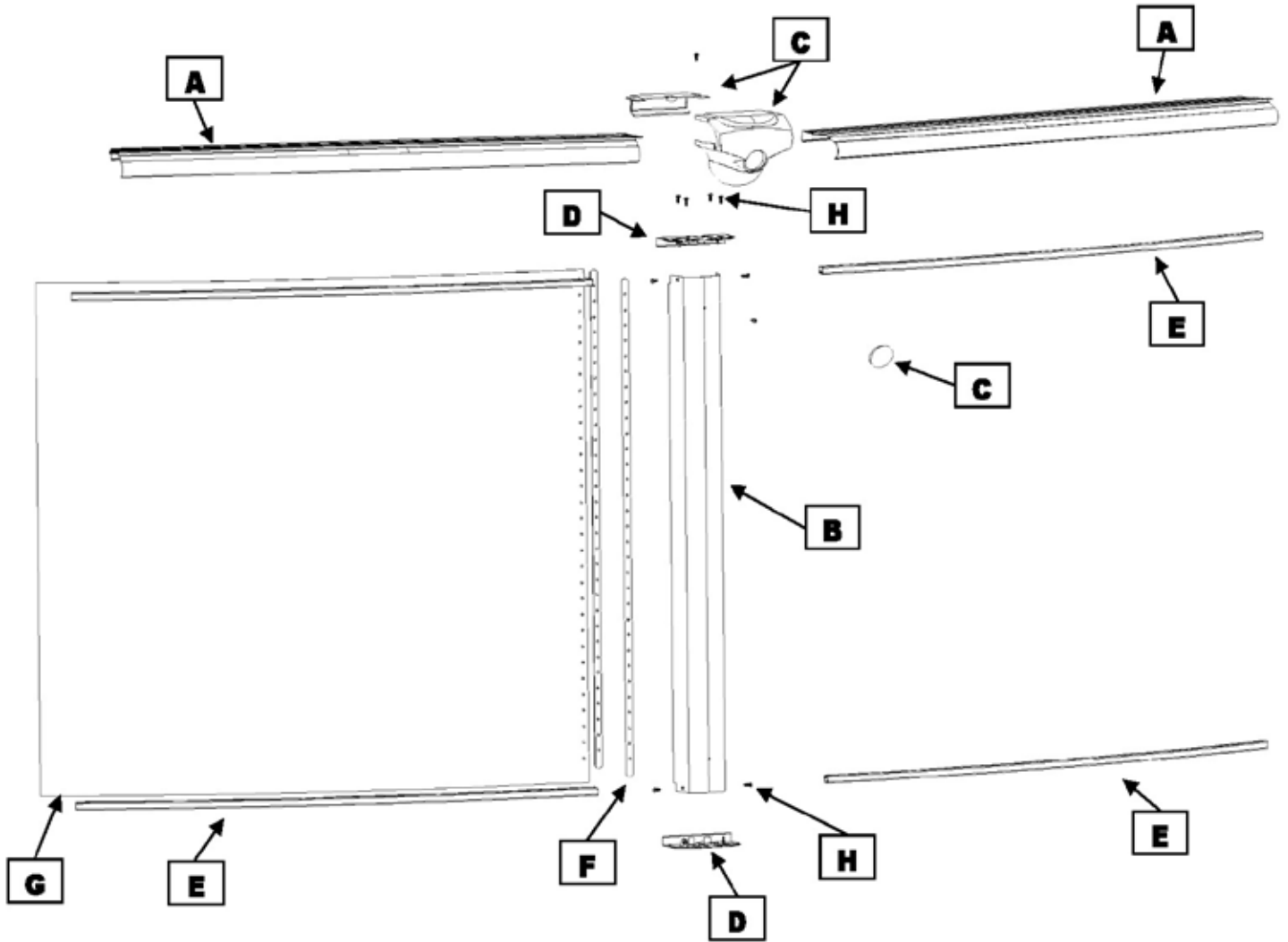

**Section
1**

**GENERAL INSTRUCTIONS - ROUND POOLS
GROUND PREPARATION**

PARTS LISTING - CONTENT

Product Description: Zenith Round			Revised Sept 2018										
Product Code : PZEN-54SSPSPSB10													
Index#	Description	Part #	Quantity required for installation (by pool size)										
			8	12	15	18	21	24	27	30	33		
A	Top ledge 30"	ART211-1295030	10										
A	Top ledge 50"	ART211-1295050		9									
A	Top ledge 52"	ART211-1295052			11	13							
A	Top ledge 53"	ART211-1295053					15	17	19	21	23		
B	Upright	ART811-R12954M	10	9	11	13	15	17	19	21	23		
C	Ledge cover	AR211-23120ABC	10	9	11	13	15	17	19	21	23		
D	Bottom/Top plate	21120A	20	18	22	26	30	34	38	42	46		
E	Stabilizer/Bottom Rail	LA1254108	20										
E	Stabilizer/Bottom Rail	LA1254112		18									
E	Stabilizer/Bottom Rail	LA1254115			22								
E	Stabilizer/Bottom Rail	LA1254118				26							
E	Stabilizer/Bottom Rail	LA1254121					30						
E	Stabilizer/Bottom Rail	LA1254124						34					
E	Stabilizer/Bottom Rail	LA1254127							38				
E	Stabilizer/Bottom Rail	LA1255330								42	46		
F	Steel bars	11823	2	2	2	2	2	2	2	2	2	2	2
G	Wall		1	1	1	1	1	1	1	1	1	1	1
H	Screw 12x3/4	V12x34	102	98	113	133	153	174	194	215	235		
*	Hardware bag/pool	SACV12X34-102	1										
*	Hardware bag/pool	SACV12X34-98		1									
*	Hardware bag/pool	SACV12X34-113			1								
*	Hardware bag/pool	SACV12X34-133				1							
*	Hardware bag/pool	SACV12X34-153					1						
*	Hardware bag/pool	SACV12X34-174						1					
*	Hardware bag/pool	SACV12X34-194							1				
*	Hardware bag/pool	SACV12X34-215								1			
*	Hardware bag/pool	SACV12X34-235										1	
**	Hardware bag/wall	1050000054	1	1	1	1	1	1	1	1	1	1	1
	Thrus phill 18-8 bolts 18-8 1/4-0x3/4	99-0023	31	31	31	31	31	31	31	31	31	31	31
	Flange nuts S/S 1/4-20 Serrated	2FGS422	31	31	31	31	31	31	31	31	31	31	31
	Instruction DVD	SACWBI36876	1	1	1	1	1	1	1	1	1	1	1

* In the hardware bag/pool you will find parts: #V12x34

** In the hardware bag/wall you will find parts: #99-0023 - #2FGS422

Section
1

GENERAL INSTRUCTIONS - ROUND POOLS
GROUND PREPARATION

PARTS LISTING - EXPLODED VIEW

Zenith DLX STR
PZEN-52SSPSPSB11
Round

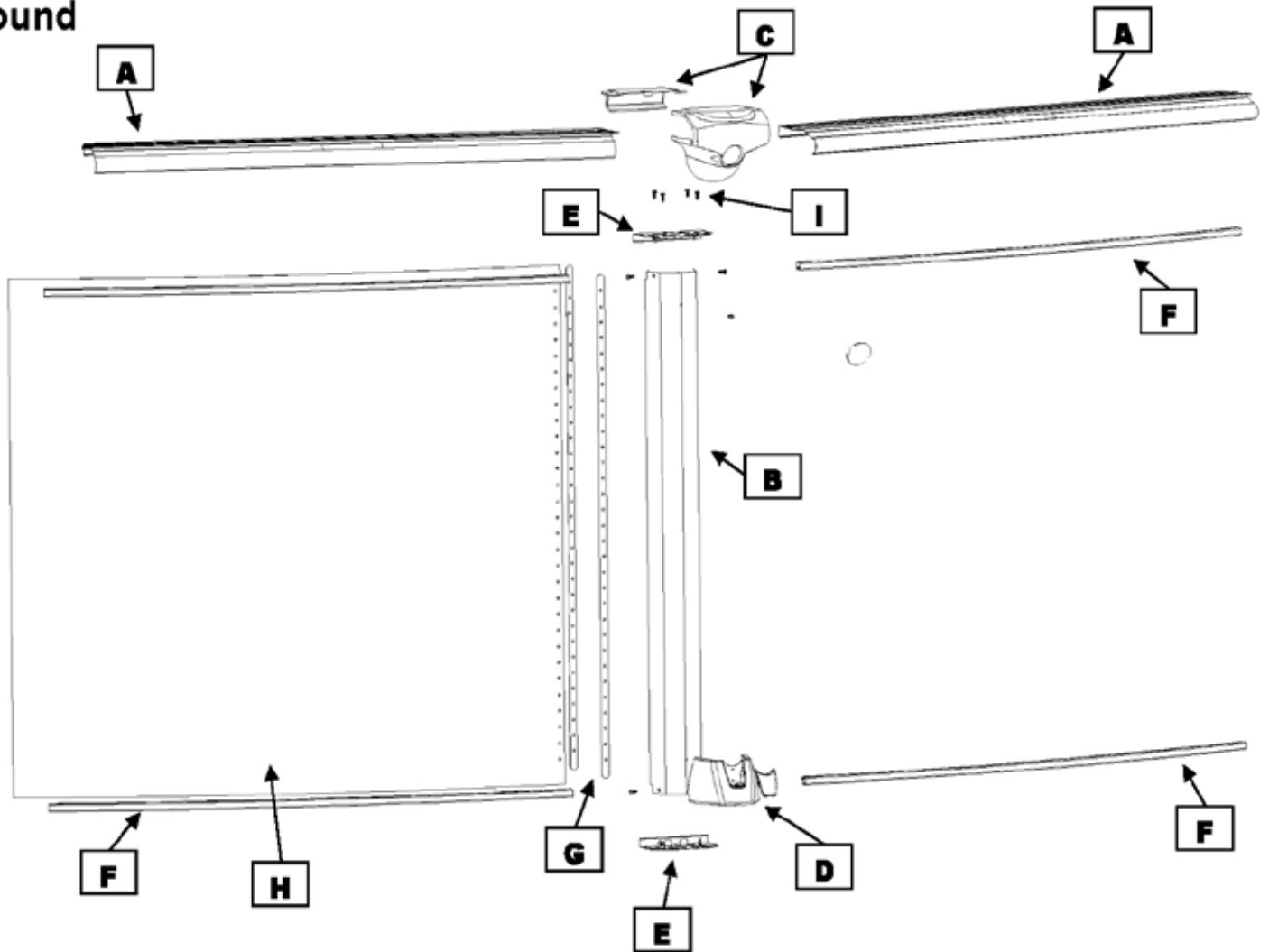

**Section
1**

**GENERAL INSTRUCTIONS - ROUND POOLS
GROUND PREPARATION**

PARTS LISTING - CONTENT

Product Description: Zenith DLX Round			Revised Sept 2018							
Product Code: PZEN-52SSPSPSB11			Quantity required for installation (by pool size)							
Index #	Description	Part #	8	12	15	18	21	24	27	30
A	Top ledge 30"	ART211-1295030	10							
A	Top ledge 50"	ART211-1295050		9						
A	Top ledge 52"	ART211-1295052			11	13				
A	Top ledge 53"	ART211-1295053					15	17	19	21
B	Upright	ART711-R12954M	10	9	11	13	15	17	19	21
C	Ledge cover	AR211-23120ABC	10	9	11	13	15	17	19	21
D	Foot Cover	AR711-23300AC	10	9	11	13	15	17	19	21
E	Top/Bottom Plate	21120A	20	18	22	26	30	34	38	42
F	Stabilizer/Bottom Rail	LA1254108	20							
F	Stabilizer/Bottom Rail	LA1254112		18						
F	Stabilizer/Bottom Rail	LA1254115			22					
F	Stabilizer/Bottom Rail	LA1254118				26				
F	Stabilizer/Bottom Rail	LA1254121					30			
F	Stabilizer/Bottom Rail	LA1254124						34		
F	Stabilizer/Bottom Rail	LA1254127							38	
F	Stabilizer/Bottom Rail	LA1255330								42
G	Steel bars	11823	2	2	2	2	2	2	2	2
H	Wall		1	1	1	1	1	1	1	1
I	Screw 12x3/4	V12x34	113	102	129	147	169	191	215	235
*	Hardware bag/pool	SACV12X34-113	1							
*	Hardware bag/pool	SACV12X34-129			1					
*	Hardware bag/pool	SACV12X34-102		1						
*	Hardware bag/pool	SACV12X34-147				1				
*	Hardware bag/pool	SACV12X34-169					1			
*	Hardware bag/pool	SACV12X34-191						1		
*	Hardware bag/pool	SACV12X34-215							1	
*	Hardware bag/pool	SACV12X34-235								1
**	Hardware bag/wall	1050000054	1	1	1	1	1	1	1	1
	ThruSS phill 18-8 bolts 18-8 1/4-0x3/4	99-0023	31	31	31	31	31	31	31	31
	Flange nuts S/S 1/4-20 Serrated	2FGS422	31	31	31	31	31	31	31	31
	Instruction DVD	SACWBI36876	1	1	1	1	1	1	1	1

* In the hardware bag/pool you will find parts: #V12x34

** In the hardware bag/wall you will find parts: #99-0023 - 2FGS422

Section
1

GENERAL INSTRUCTIONS - ROUND POOLS
GROUND PREPARATION

PARTS LISTING - EXPLODED VIEW

Zenith DLX STR
PZEN-54SSPSPSB11
Round

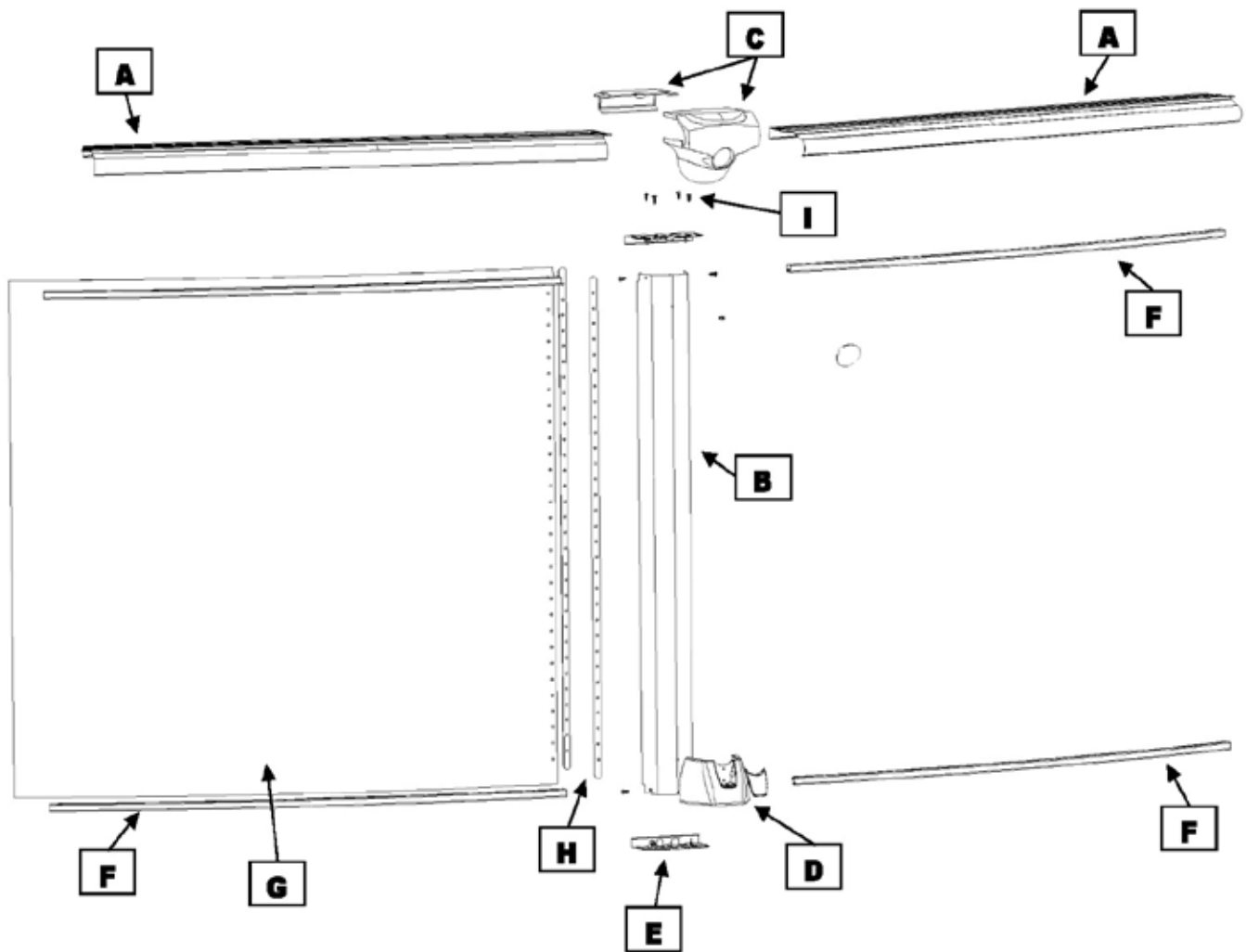

**Section
1**

**GENERAL INSTRUCTIONS - ROUND POOLS
GROUND PREPARATION**

PARTS LISTING - CONTENT

Product Description:			Zenith DLX Round						Revised Sept 2018
Product Code:			PZEN-54SSPSPB11						
			Quantity required for installation (by pool size)						
Index #	Description	Part #	12	15	18	21	24	27	
A	Top ledge 50"	ART211-1295050	9						
A	Top ledge 52"	ART211-1295052		11	13				
A	Top ledge 53"	ART211-1295053				15	17	19	
B	Upright	ART811-R12954M	9	11	13	15	17	19	
C	Ledge cover	AR211-23120ABC	9	11	13	15	17	19	
D	Foot Cover	AR711-23300AC	9	11	13	15	17	19	
E	Top / Bottom plate	21120A	18	22	26	30	34	38	
F	Stabilizer/ Bottom rail	LA1254112	18						
F	Stabilizer/ Bottom rail	LA1254115		22					
F	Stabilizer/ Bottom rail	LA1254118			26				
F	Stabilizer/ Bottom rail	LA1254121				30			
F	Stabilizer/ Bottom rail	LA1254124					34		
F	Stabilizer/ Bottom rail	LA1254127						38	
G	Wall		1	1	1	1	1	1	
H	Steel bars	11823	2	2	2	2	2	2	
I	Screw 12x3/4	V12x34	102	129	147	169	191	215	
*	Hardware bag/pool	SACV12X34-102	1						
*	Hardware bag/pool	SACV12X34-129		1					
*	Hardware bag/pool	SACV12X34-147			1				
*	Hardware bag/pool	SACV12X34-169				1			
*	Hardware bag/pool	SACV12X34-191					1		
*	Hardware bag/pool	SACV12X34-215						1	
**	Hardware bag/wall	1050000054	1	1	1	1	1	1	
	Thrusl phill 18-8 bolts 18-8 1/4-x3/4	99-0023	31	31	31	31	31	31	
	Flange nuts S/S 1/4-20 Serrated	2FGS422	31	31	31	31	31	31	
	Instruction DVD	SACWBI36876	1	1	1	1	1	1	

* In the hardware bag/pool you will find parts: V12x34

** In the hardware bag/wall you will find parts: #99-0023 - #2FGS422

Section
1

GENERAL INSTRUCTIONS - ROUND POOLS
GROUND PREPARATION

PARTS LISTING - EXPLODED VIEW

Zenith LX STR
PZENLX-52SSPSPSB20
Round

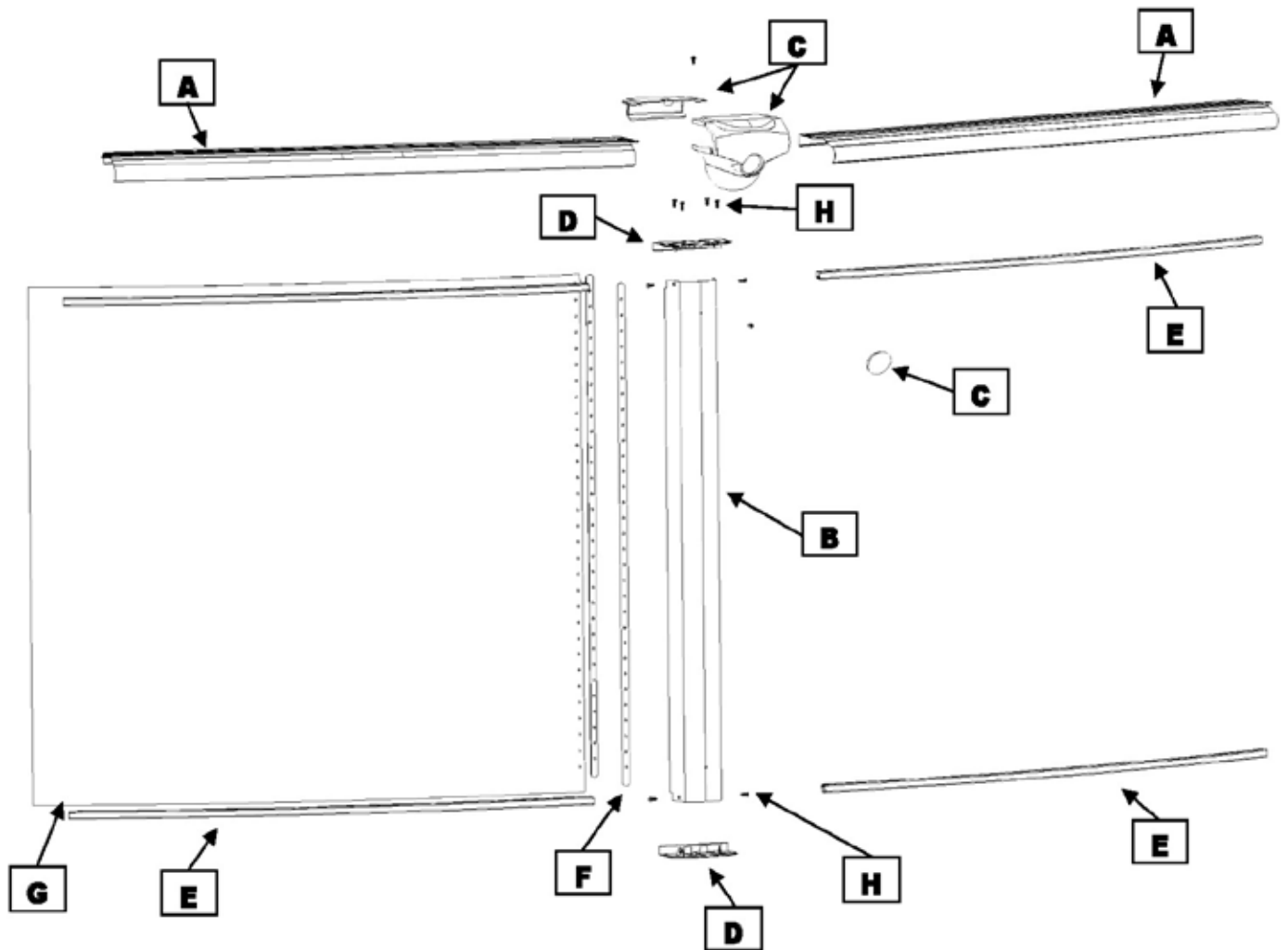

**Section
1**

**GENERAL INSTRUCTIONS - ROUND POOLS
GROUND PREPARATION**

PARTS LISTING - CONTENT

Product Description:		Zenith LX Round	Revised Sept 2018							
Product Code:		PZENLX-52SSPSPB20	Quantity required for installation (by pool size)							
Index #	Description	Part #	8	12	15	18	21	24	27	30
A	Top ledge 30"	ART211-1295030	10							
A	Top ledge 50"	ART211-1295050		9						
A	Top ledge 52"	ART211-1295052			11	13				
A	Top ledge 53"	ART211-1295053					15	17	19	21
B	Upright	ART711-R12954M	10	9	11	13	15	17	19	21
C	Ledge cover	CB211-23120ABC	10	9	11	13	15	17	19	21
D	Top/Bottom Plate	21120A	20	18	22	26	30	34	38	42
E	Stabilizer/Bottom Rail	LA1254108	20							
E	Stabilizer/Bottom Rail	LA1254112		18						
E	Stabilizer/Bottom Rail	LA1254115			22					
E	Stabilizer/Bottom Rail	LA1254118				26				
E	Stabilizer/Bottom Rail	LA1254121					30			
E	Stabilizer/Bottom Rail	LA1254124						34		
E	Stabilizer/Bottom Rail	LA1254127							38	
E	Stabilizer/Bottom Rail	LA1255330								42
F	Steel bars	11823	2	2	2	2	2	2	2	2
G	Wall		1	1	1	1	1	1	1	1
H	Screw 12x3/4	V12x34	102	98	113	133	153	174	194	215
*	Hardware bag/pool	SACV12X34-98		1						
*	Hardware bag/pool	SACV12X34-113			1					
*	Hardware bag/pool	SACV12X34-102	1							
*	Hardware bag/pool	SACV12X34-133				1				
*	Hardware bag/pool	SACV12X34-153					1			
*	Hardware bag/pool	SACV12X34-174						1		
*	Hardware bag/pool	SACV12X34-194							1	
*	Hardware bag/pool	SACV12X34-215								1
**	Hardware bag/wall	1050000054	1	1	1	1	1	1	1	1
	Thru ss phill 18-8 bolts 18-8 1/4-0x3/4	99-0023	31	31	31	31	31	31	31	31
	Flange nuts S/S 1/4-20 Serrated	2FGS422	31	31	31	31	31	31	31	31
	Instruction DVD	SACWBI36876	1	1	1	1	1	1	1	1

* In the hardware bag/pool you will find parts: #V12x34

** In the hardware bag/wall you will find parts: #99-0023 - #2FGS422

Section
1

GENERAL INSTRUCTIONS - ROUND POOLS
GROUND PREPARATION

PARTS LISTING - EXPLODED VIEW

Zenith LX STR
PZENLX-52SSPSPSB21
Round

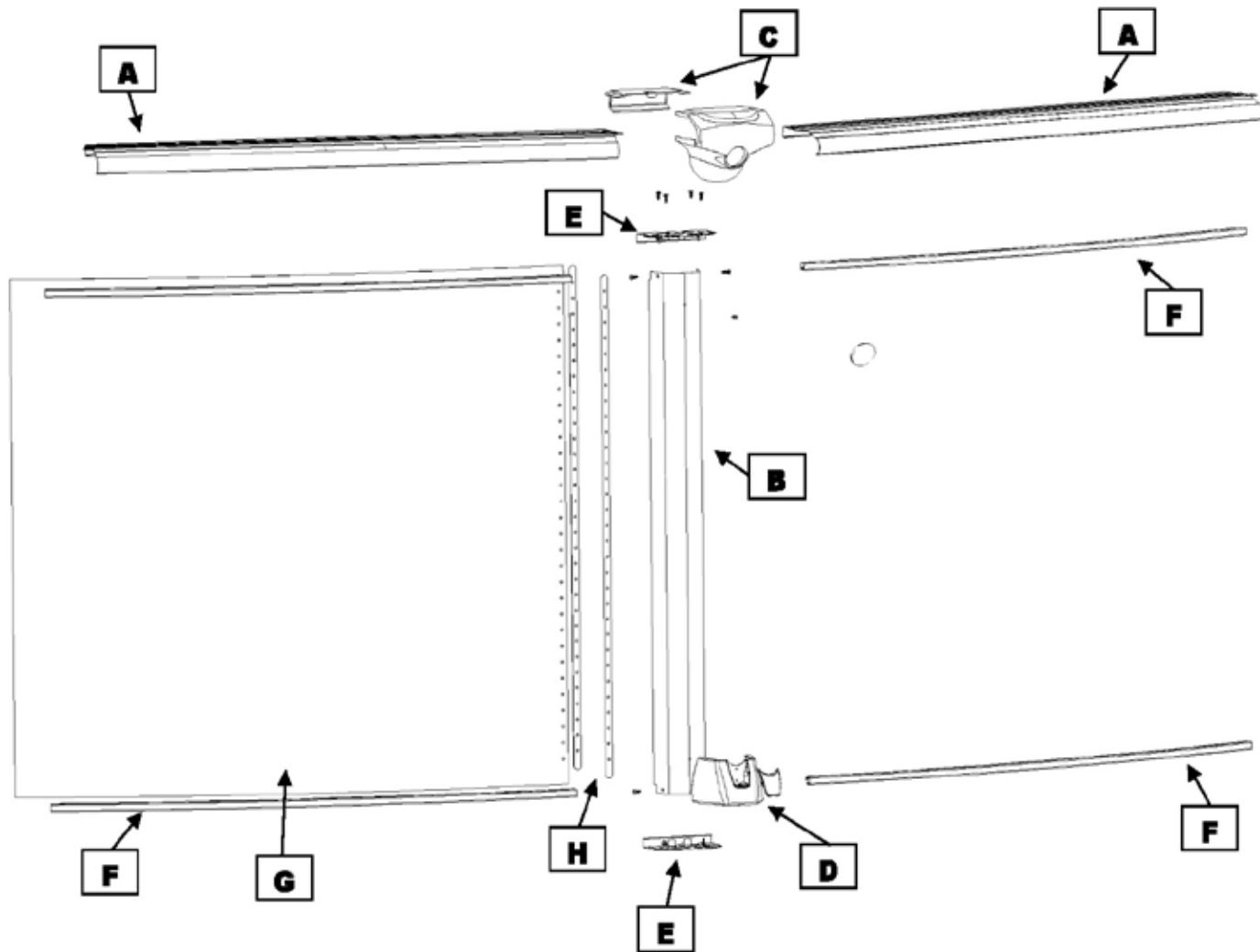

**Section
1**

**GENERAL INSTRUCTIONS - ROUND POOLS
GROUND PREPARATION**

PARTS LISTING - CONTENT

Product Description:		Zenith LX Round	Revised Sept 2018							
Product Code:		PZENLX-52SSPSPSB21								
Index#	Description	Part #	Quantity required for installation (by pool size)							
			8	12	15	18	21	24	27	30
A	Top ledge 30"	ART211-1295030	10							
A	Top ledge 50"	ART211-1295050		9						
A	Top ledge 52"	ART211-1295052			11	13				
A	Top ledge 53"	ART211-1295053					15	17	19	21
B	Upright	ART711-R12954M	10	9	11	13	15	17	19	21
C	Ledge cover	CB211-23120ABC	10	9	11	13	15	17	19	21
D	Foot Cover	CB711-23300AC	10	9	11	13	15	17	19	21
E	Top/Bottom Plate	21120A	20	18	22	26	30	34	38	42
F	Stabilizer/Bottom Rail	LA1254108	20							
F	Stabilizer/Bottom Rail	LA1254112		18						
F	Stabilizer/Bottom Rail	LA1254115			22					
F	Stabilizer/Bottom Rail	LA1254118				26				
F	Stabilizer/Bottom Rail	LA1254121					30			
F	Stabilizer/Bottom Rail	LA1254124						34		
F	Stabilizer/Bottom Rail	LA1254127							38	
F	Stabilizer/Bottom Rail	LA1255330								42
G	Wall		1	1	1	1	1	1	1	1
H	Steel bars	11823	2	2	2	2	2	2	2	2
I	Screw 12x3/4	V12x34	113	102	129	147	169	191	215	235
*	Hardware bag/pool	SACV12X34-98		1						
*	Hardware bag/pool	SACV12X34-113	1							
*	Hardware bag/pool	SACV12X34-129			1					
*	Hardware bag/pool	SACV12X34-102		1						
*	Hardware bag/pool	SACV12X34-147				1				
*	Hardware bag/pool	SACV12X34-169					1			
*	Hardware bag/pool	SACV12X34-191						1		
*	Hardware bag/pool	SACV12X34-215							1	
*	Hardware bag/pool	SACV12X34-235								1
**	Hardware bag/wall	1050000054	1	1	1	1	1	1	1	1
	Thrust phill 18-8 bolts 18-8 1/4-0x3/4	99-0023	31	31	31	31	31	31	31	31
	Flange nuts S/S 1/4-20 Serrated	2FGS422	31	31	31	31	31	31	31	31
	Instruction DVD	SACWBI36876	1	1	1	1	1	1	1	1

* In the hardware bag/pool you will find parts: #V12x34

** In the hardware bag/wall you will find parts: #99-0023 - #2FGS422

Section
1

GENERAL INSTRUCTIONS - ROUND POOLS
GROUND PREPARATION

PARTS LISTING - EXPLODED VIEW

Ohana STR
PZEN-52SSPSPSB11
Round

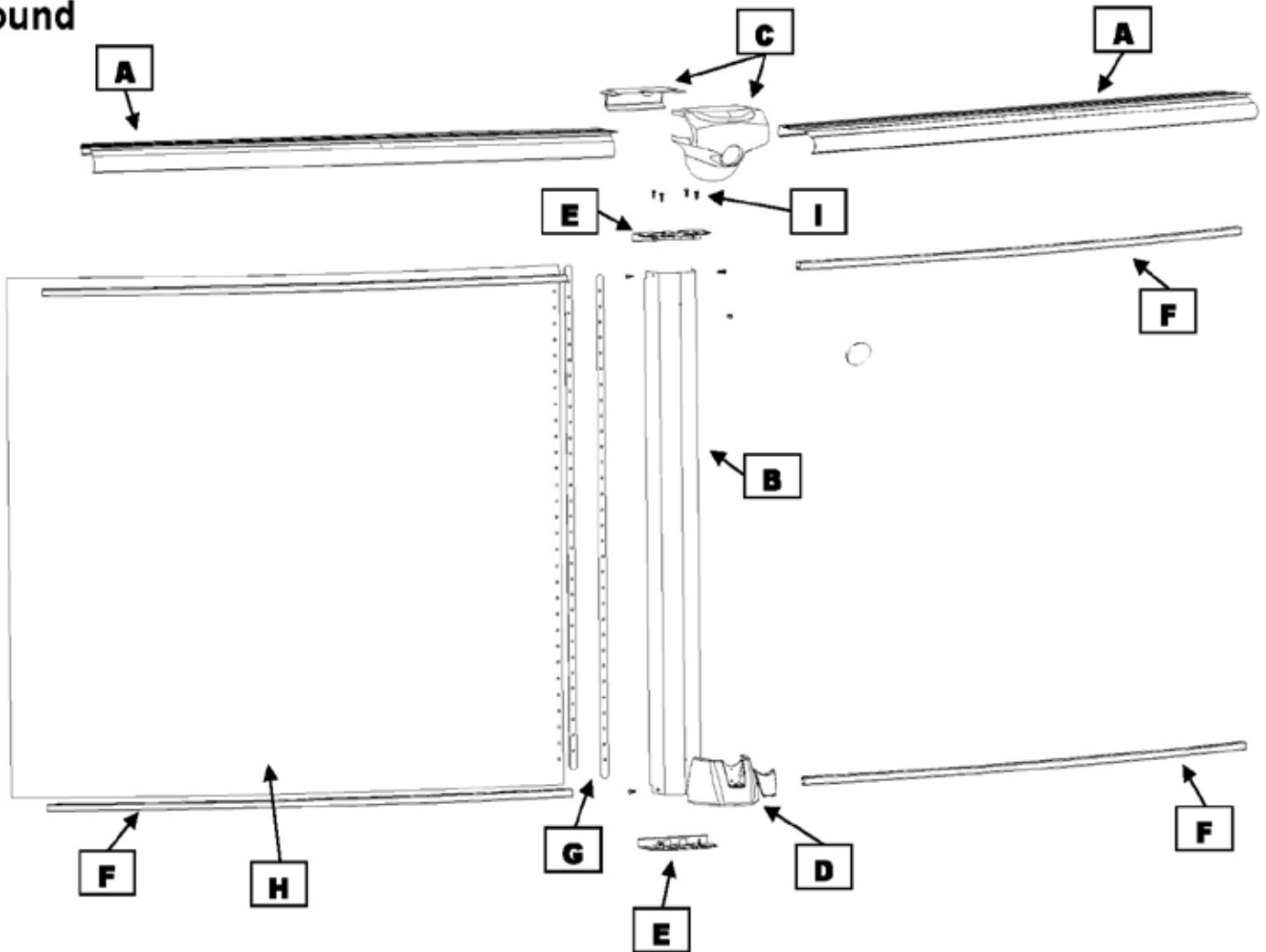

**Section
1**

**GENERAL INSTRUCTIONS - ROUND POOLS
GROUND PREPARATION**

PARTS LISTING - CONTENT

Product Description:			Ohana Round								Revised Sept 2018			
Product Code:			PZEN-52SSPSPB11											
Index #	Description	Part #	Quantity required for installation (by pool size)											
			8	12	15	18	21	24	27	30	33			
A	Top ledge 30"	ART211-1295030	10											
A	Top ledge 50"	ART211-1295050		9										
A	Top ledge 52"	ART211-1295052			11	13								
A	Top ledge 53"	ART211-1295053					15	17	19	21	23			
B	Upright	ART711-R12954M	10	9	11	13	15	17	19	21	23			
C	Ledge cover	AR211-23120ABC	10	9	11	13	15	17	19	21	23			
D	Foot Cover	AR711-23300AC	10	9	11	13	15	17	19	21	23			
E	Top/Bottom Plate	21120A	20	18	22	26	30	34	38	42	46			
F	Stabilizer/Bottom Rail	LA1254108	20											
F	Stabilizer/Bottom Rail	LA1254112		18										
F	Stabilizer/Bottom Rail	LA1254115			22									
F	Stabilizer/Bottom Rail	LA1254118				26								
F	Stabilizer/Bottom Rail	LA1254121					30							
F	Stabilizer/Bottom Rail	LA1254124						34						
F	Stabilizer/Bottom Rail	LA1254127							38					
F	Stabilizer/Bottom Rail	LA1255330								42	46			
G	Steel bars	11823	2	2	2	2	2	2	2	2	2			
H	Wall		1	1	1	1	1	1	1	1	1			
I	Screw 12x3/4	V12x34	113	102	129	147	169	191	215	235	266			
*	Hardware bag/pool	SACV12X34-113	1											
*	Hardware bag/pool	SACV12X34-129			1									
*	Hardware bag/pool	SACV12X34-102		1										
*	Hardware bag/pool	SACV12X34-147				1								
*	Hardware bag/pool	SACV12X34-169					1							
*	Hardware bag/pool	SACV12X34-191						1						
*	Hardware bag/pool	SACV12X34-215							1					
*	Hardware bag/pool	SACV12X34-235								1				
*	Hardware bag/pool	SACV12x34-266											1	
**	Hardware bag/wall	1050000054	1	1	1	1	1	1	1	1	1			
	Thrust phill 18-8 bolts 18-8 1/4-0x3/4	99-0023	31	31	31	31	31	31	31	31	31			
	Flange nuts S/S 1/4-20 Serrated	2FGS422	31	31	31	31	31	31	31	31	31			
	Instruction DVD	SACWBI36876	1	1	1	1	1	1	1	1	1			

* In the hardware bag/pool you will find parts: #V12x34

** In the hardware bag/wall you will find parts: #99-0023 - 2FGS422

Section
1

GENERAL INSTRUCTIONS - ROUND POOLS
GROUND PREPARATION

PARTS LISTING - EXPLODED VIEW

Zenith RTR
PZEN-52RSPSPSB10
Round

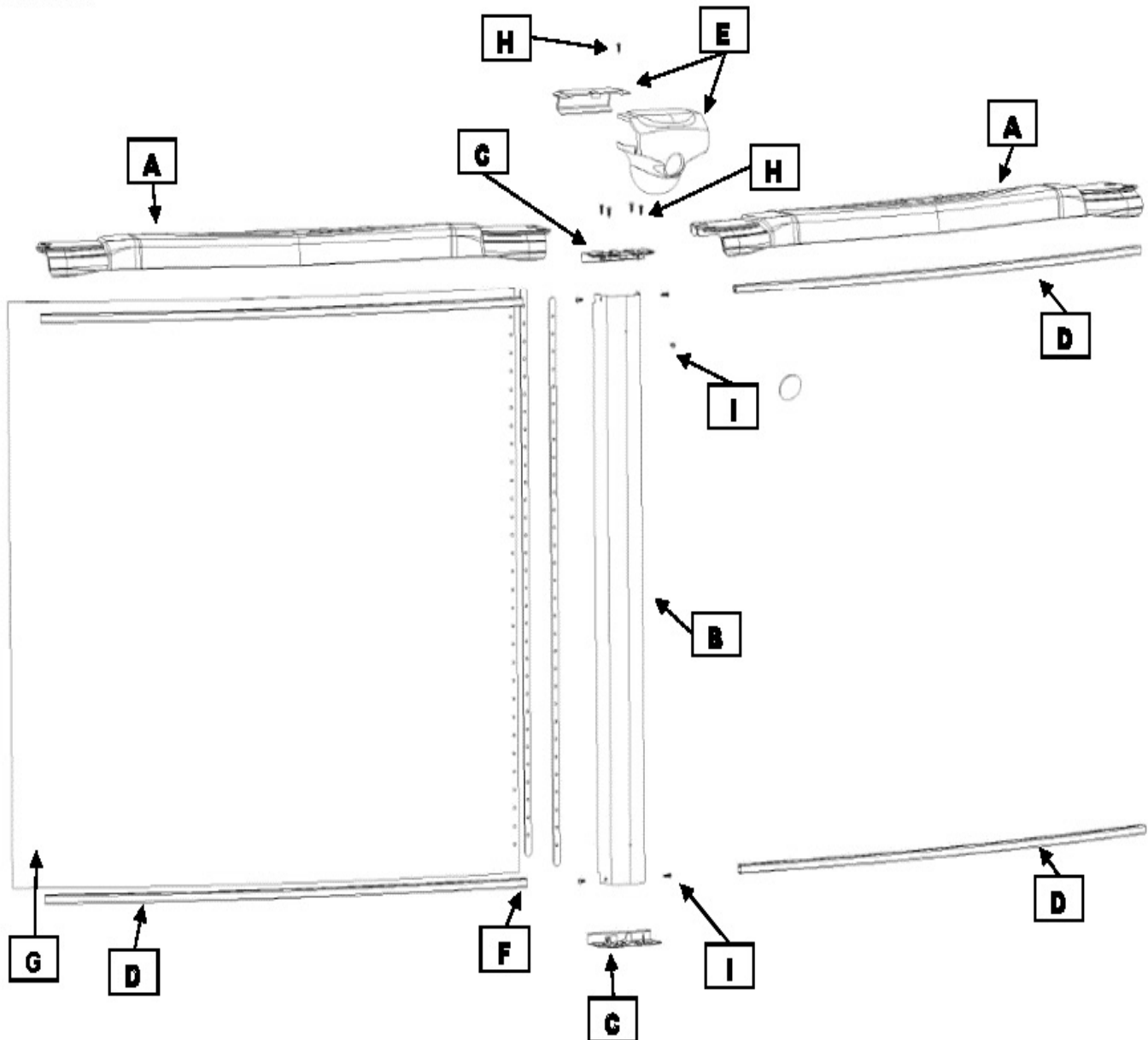

Section 1

GENERAL INSTRUCTIONS - ROUND POOLS GROUND PREPARATION

PARTS LISTING - CONTENT

Product Description :		Zenith Round	Revised Sept 2018							
Product Code:		PZEN-52RSPSPB10								
Index#	Description	Part #	Quantity required for installation (by pool size)							
			12	15	18	21	24	27	30	33
A	Top ledge	AR744-001-R	8	10	12	14	16	18	20	22
B	Upright	ART711-R12954M	8	10	12	14	16	18	20	22
C	Top / Bottom plate	21120A	16	20	24	28	32	36	40	44
D	Stabilizer/Bottom rail	LA1255612	16							
D	Stabilizer/Bottom rail	LA1255615		20						
D	Stabilizer/Bottom rail	LA1255618			24					
D	Stabilizer/Bottom rail	LA1255621				28				
D	Stabilizer/Bottom rail	LA1255624					32			
D	Stabilizer/Bottom rail	LA1255627						36		
D	Stabilizer/Bottom rail	LA1255630							40	44
E	Ledge cover	AR211-23120ABC	8	10	12	14	16	18	20	22
F	Steel bars	11823	2	2	2	2	2	2	2	2
G	Wall		1	1	1	1	1	1	1	1
H	Screw 12x1-1/4S	VHL12X114S	35	42	53	63	74	74	84	95
I	Screw 12x3/4	V12x34	58	66	74	86	98	113	129	147
*	Hardware bag/pool	SACV12X34-58	1							
*	Hardware bag/pool	SACV12X34-66		1						
*	Hardware bag/pool	SACV12X34-74			1					
*	Hardware bag/pool	SACV12X34-86				1				
*	Hardware bag/pool	SACV12X34-98					1			
*	Hardware bag/pool	SACV12X34-113						1		
*	Hardware bag/pool	SACV12X34-129							1	
*	Hardware bag/pool	SACV12X34-147								1
**	Hardware bag/wall	1050000054	1	1	1	1	1	1	1	1
***	Hardware bag/pool	SACVHL12114-35	1							
***	Hardware bag/pool	SACVHL12114-42		1						
***	Hardware bag/pool	SACVHL12114-53			1					
***	Hardware bag/pool	SACVHL12114-63				1				
***	Hardware bag/pool	SACVHL12114-74					1	1		
***	Hardware bag/pool	SACVHL12114-84							1	
***	Hardware bag/pool	SACVHL12114-95								1
	Thrus phill 18-8 bolts 18-8 1/4-0x3/4	99-0023	31	31	31	31	31	31	31	31
	Flange nuts S/S 1/4-20 Serrated	2FGS422	31	31	31	31	31	31	31	31
	Instruction DVD	SACWBI36876	1	1	1	1	1	1	1	1

* In the hardware bag/pool you will find parts: #V12x34

** In the hardware bag/ wall you will find parts: #99-0023 - 2FGS422

*** In the hardware bag/pool you will find parts: #VHL12114S

Section
1

GENERAL INSTRUCTIONS - ROUND POOLS
GROUND PREPARATION

PARTS LISTING - EXPLODED VIEW

Zenith RTR
PZEN-54RSPSPSB10
Round

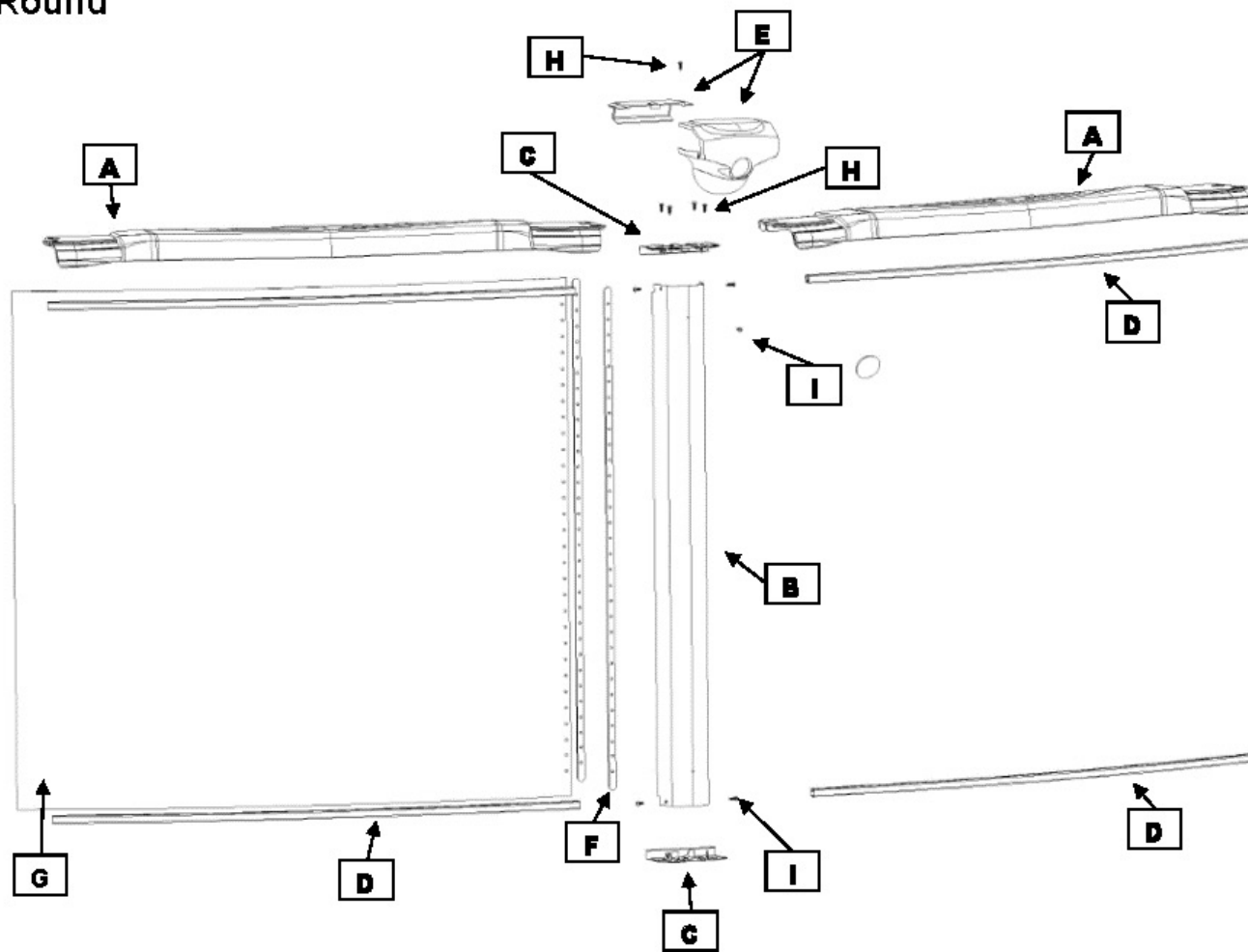

Section 1

GENERAL INSTRUCTIONS - ROUND POOLS GROUND PREPARATION

PARTS LISTING - CONTENT

Product Description :		Zenith Round		Revised Sept 2018								
Product Code:		PZEN-54RSPSPB10		Quantity required for installation (by pool size)								
Index#	Description	Part #	Length	12	15	18	21	24	27	30	33	
A	Top ledge	AR744-001-R		8	10	12	14	16	18	20	22	
B	Upright	ART811-R12954M	51,750"	8	10	12	14	16	18	20	22	
C	Top / Bottom plate	21120A		16	20	24	28	32	36	40	44	
D	Stabilizer/Bottom rail	LA1255612	55,750"	16								
D	Stabilizer/Bottom rail	LA1255615	55,875"		20							
D	Stabilizer/Bottom rail	LA1255618	55,875"			24						
D	Stabilizer/Bottom rail	LA1255621	55,750"				28					
D	Stabilizer/Bottom rail	LA1255624	56,125"					32				
D	Stabilizer/Bottom rail	LA1255627	55,690"						36			
D	Stabilizer/Bottom rail	LA1255630	56,000"							40	44	
E	Ledge cover	AR211-23120ABC		8	10	12	14	16	18	20	22	
F	Steel bars	11825	52,000"	2	2	2	2	2	2	2	2	
G	Wall			1	1	1	1	1	1	1	1	
H	Screw 12x1-1/4S	VHL12X114S		35	42	53	63	74	74	84	95	
I	Screw 12x3/4	V12x34		58	66	74	86	98	113	129	147	
*	Hardware bag/pool	SACV12X34-58		1								
*	Hardware bag/pool	SACV12X34-66			1							
*	Hardware bag/pool	SACV12X34-74				1						
*	Hardware bag/pool	SACV12X34-86					1					
*	Hardware bag/pool	SACV12X34-98						1				
*	Hardware bag/pool	SACV12X34-113							1			
*	Hardware bag/pool	SACV12X34-129								1		
*	Hardware bag/pool	SACV12X34-147									1	
**	Hardware bag/wall	1050000054		1	1	1	1	1	1	1	1	
***	Hardware bag/pool	SACVHL12114-35		1								
***	Hardware bag/pool	SACVHL12114-42			1							
***	Hardware bag/pool	SACVHL12114-53				1						
***	Hardware bag/pool	SACVHL12114-63					1					
***	Hardware bag/pool	SACVHL12114-74						1	1			
***	Hardware bag/pool	SACVHL12114-84								1		
***	Hardware bag/pool	SACVHL12114-95									1	
	Thrus phill 18-8 bolts 18-8 1/4-0x3/4	99-0023		31	31	31	31	31	31	31	31	
	Flange nuts S/S 1/4-20 Serrated	2FGS422		31	31	31	31	31	31	31	31	
	Instruction DVD	SACWBI36876		1	1	1	1	1	1	1	1	

* In the hardware bag/pool you will find parts: #V12x34

** In the hardware bag/ wall you will find parts: #99-0023 - 2FGS422

*** In the hardware bag/pool you will find parts: #VHL12114S

Section
1

GENERAL INSTRUCTIONS - ROUND POOLS
GROUND PREPARATION

PARTS LISTING - EXPLODED VIEW

Zenith RTR
PZEN-54RSRRRRB11
Round

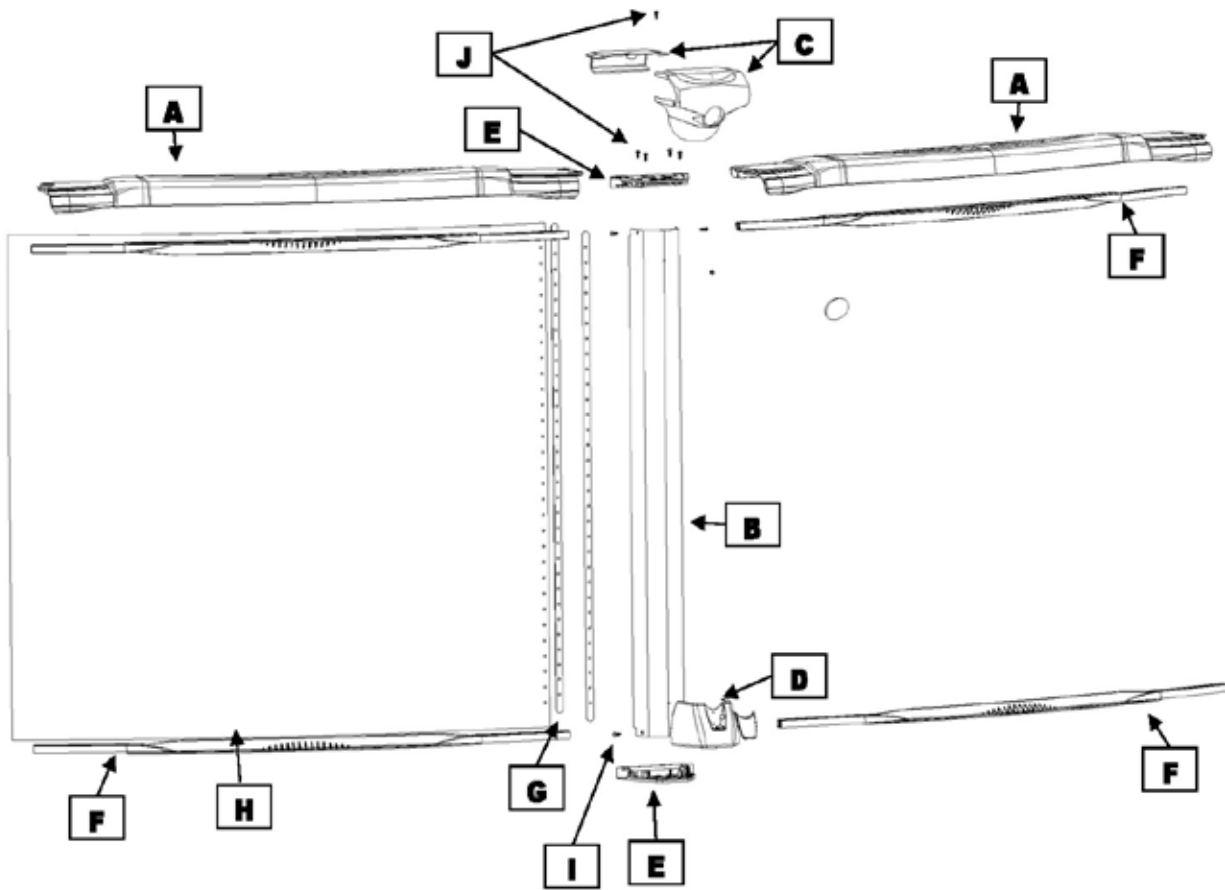

Section 1

GENERAL INSTRUCTIONS - ROUND POOLS GROUND PREPARATION

PARTS LISTING - CONTENT

Product Description :		Zenith Round		Revised Sept 2018						
Product Code :		PZEN-54RSRRRRB11								
Index #	Description	Part #	Quantity required for installation (by pool size)							
			12	15	18	21	24	27	30	33
A	Top ledge	AR744-001-R	8	10	12	14	16	18	20	22
B	Upright	ART811-R12954M	8	10	12	14	16	18	20	22
C	Ledge cover	AR211-23120ABC	8	10	12	14	16	18	20	22
D	Foot cover	AR711-23300AC	8	10	12	14	16	18	20	22
E	Top plate	CG21120A	8	10	12	14	16	18	20	22
E	Bottom plate	CG21120B	8	10	12	14	16	18	20	22
F	Stabilizer / Bottom rail 15D	1525515	16	20	24					
F	Stabilizer / Bottom rail 24D	1525524				28	32	36		
F	Stabilizer / Bottom rail 30D	1525530							40	44
G	Steel bars	11825	2	2	2	2	2	2	2	2
H	Wall		1	1	1	1	1	1	1	1
I	Screw 12x3/4	V12x34	49	66	86	98	102	113	129	133
J	Screw 12x1-1/4S	VHL12X114S	42	53	63	74	84	95	105	110
*	Hardware bag/pool	SACV12X34-49	1							
*	Hardware bag/pool	SACV12X34-66		1						
*	Hardware bag/pool	SACV12X34-86			1					
*	Hardware bag/pool	SACV12X34-98				1				
*	Hardware bag/pool	SACV12X34-102					1			
*	Hardware bag/pool	SACV12X34-113						1		
*	Hardware bag/pool	SACV12X34-129							1	
*	Hardware bag/pool	SACV12X34-133								1
**	Hardware bag/wall	1050000054	1	1	1	1	1	1	1	1
***	Hardware bag/pool	SACVHL12114-22								5
***	Hardware bag/pool	SACVHL12114-42	1							
***	Hardware bag/pool	SACVHL12114-53		1						
***	Hardware bag/pool	SACVHL12114-63			1					
***	Hardware bag/pool	SACVHL12114-74				1				
***	Hardware bag/pool	SACVHL12114-84					1			
***	Hardware bag/pool	SACVHL12114-95						1		
***	Hardware bag/pool	SACVHL12114-105							1	
	Thrus phill 18-8 bolts 18-8 1/4-0x3/4	99-0023	31	31	31	31	31	31	31	31
	Flange nuts S/S 1/4-20 Serrated	2FGS422	31	31	31	31	31	31	31	31
	Instruction DVD	SACWBI36876	1	1	1	1	1	1	1	1

* In the hardware bag/pool you will find parts: #V12x34

** In the hardware bag/wall you will find parts: #99-0023 - 2FGS422

*** In the hardware bag/pool you will find parts: #VHL12114S

Section
1

GENERAL INSTRUCTIONS - ROUND POOLS
GROUND PREPARATION

PARTS LISTING - EXPLODED VIEW

Simbio RTR
PZEN-52RSPSPSB10
Round

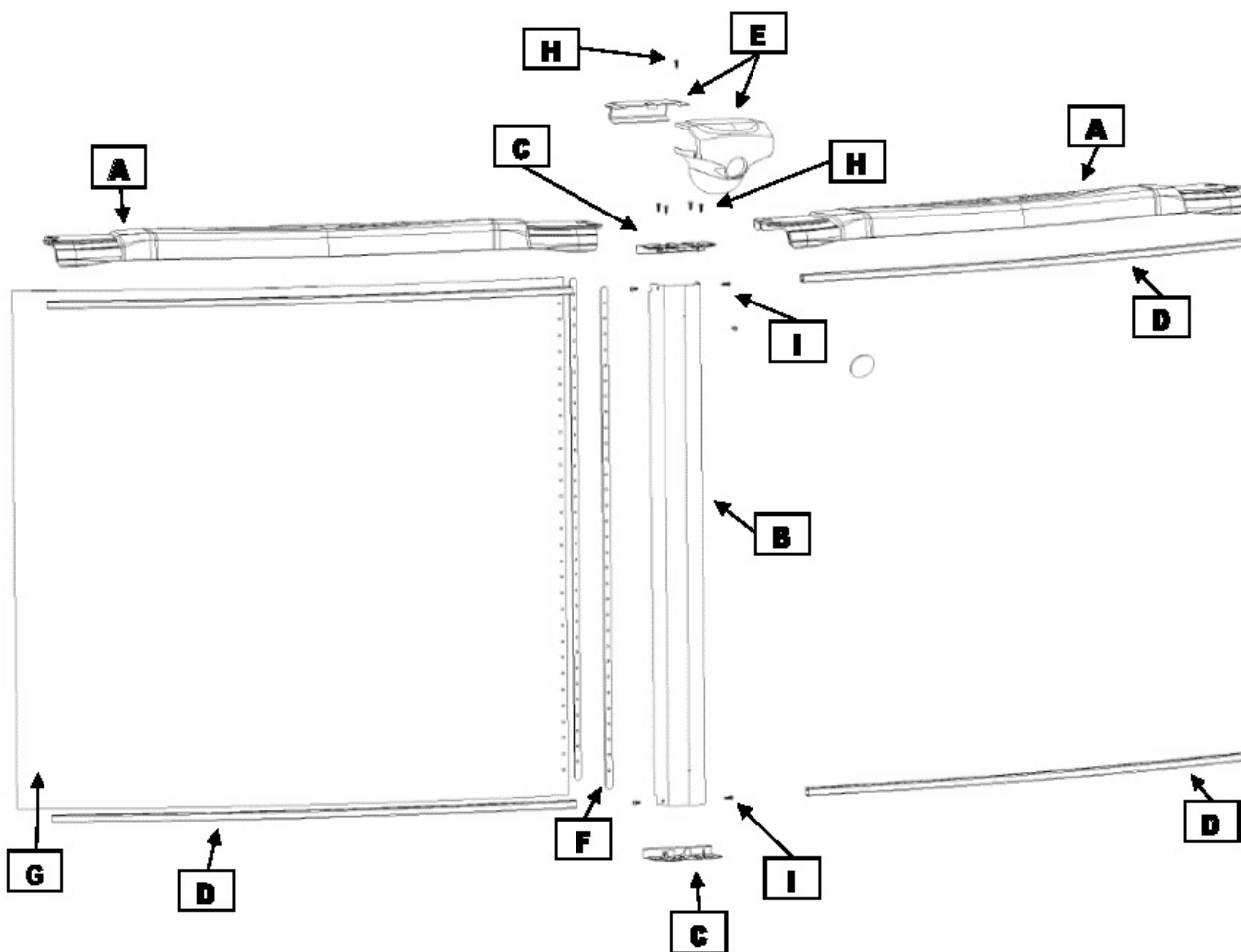

**Section
1**

**GENERAL INSTRUCTIONS - ROUND POOLS
GROUND PREPARATION**

PARTS LISTING - CONTENT

Product Description :			Simbio Round								Revised Sept 2018
Product Code:			PZEN-52RSPSPSB10								
			Quantity required for installation (by pool size)								
Index#	Description	Part #	12	15	18	21	24	27	30	33	
A	Top ledge	AR744-001-R	8	10	12	14	16	18	20	22	
B	Upright	ART711-R12954M	8	10	12	14	16	18	20	22	
C	Top / Bottom plate	21120A	16	20	24	28	32	36	40	44	
D	Stabilizer/Bottom rail	LA1255612	16								
D	Stabilizer/Bottom rail	LA1255615		20							
D	Stabilizer/Bottom rail	LA1255618			24						
D	Stabilizer/Bottom rail	LA1255621				28					
D	Stabilizer/Bottom rail	LA1255624					32				
D	Stabilizer/Bottom rail	LA1255627						36			
D	Stabilizer/Bottom rail	LA1255630							40	44	
E	Ledge cover	AR211-23120ABC	8	10	12	14	16	18	20	22	
F	Steel bars	11823	2	2	2	2	2	2	2	2	
G	Wall		1	1	1	1	1	1	1	1	
H	Screw 12x1-1/4S	VHL12X114S	35	42	53	63	74	74	84	95	
I	Screw 12x3/4	V12x34	58	66	74	86	98	113	129	147	
*	Hardware bag/pool	SACV12X34-58	1								
*	Hardware bag/pool	SACV12X34-66		1							
*	Hardware bag/pool	SACV12X34-74			1						
*	Hardware bag/pool	SACV12X34-86				1					
*	Hardware bag/pool	SACV12X34-98					1				
*	Hardware bag/pool	SACV12X34-113						1			
*	Hardware bag/pool	SACV12X34-129							1		
*	Hardware bag/pool	SACV12X34-147								1	
**	Hardware bag/wall	1050000054	1	1	1	1	1	1	1	1	
***	Hardware bag/pool	SACVHL12114-35	1								
***	Hardware bag/pool	SACVHL12114-42		1							
***	Hardware bag/pool	SACVHL12114-53			1						
***	Hardware bag/pool	SACVHL12114-63				1					
***	Hardware bag/pool	SACVHL12114-74					1	1			
***	Hardware bag/pool	SACVHL12114-84							1		
***	Hardware bag/pool	SACVHL12114-95								1	
	Thrus phill 18-8 bolts 18-8 1/4-0x3/4	99-0023	31	31	31	31	31	31	31	31	
	Flange nuts S/S 1/4-20 Serrated	2FGS422	31	31	31	31	31	31	31	31	
	Instruction DVD	SACWBI36876	1	1	1	1	1	1	1	1	

* In the hardware bag/pool you will find parts: #V12x34

** In the hardware bag/ wall you will find parts: #99-0023 - 2FGS422

*** In the hardware bag/pool you will find parts: #VHL12114S

Section
1

GENERAL INSTRUCTIONS - ROUND POOLS
GROUND PREPARATION

PARTS LISTING - EXPLODED VIEW

Simbio DLX RTR
PZEN-52RSRRRRB11
Round

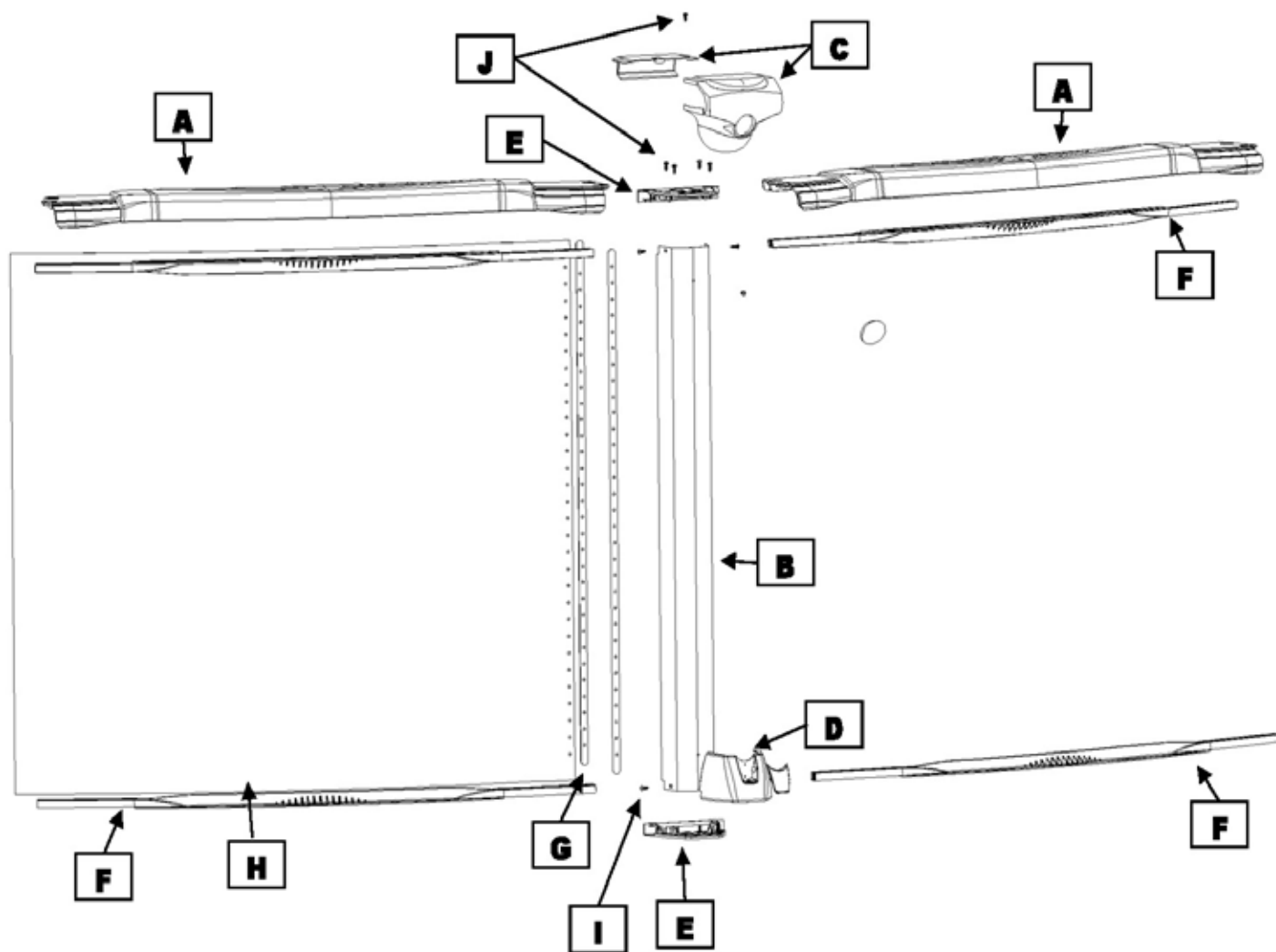

Section 1

GENERAL INSTRUCTIONS - ROUND POOLS GROUND PREPARATION

PARTS LISTING - CONTENT

Product Description :			Simbio DLX Round							Revised Sept 2018
Product Code :			PZEN-52RSRRRB11							
Index #	Description	Part #	Quantity required for installation (by pool size)							
			12	15	18	21	24	27	30	
A	Top ledge	AR744-001-R	8	10	12	14	16	18	20	
B	Upright	ART711-R12954M	8	10	12	14	16	18	20	
C	Ledge cover	AR211-23120ABC	8	10	12	14	16	18	20	
D	Foot cover	AR711-23300AC	8	10	12	14	16	18	20	
E	Top plate	CG21120A	8	10	12	14	16	18	20	
E	Bottom plate	CG21120B	8	10	12	14	16	18	20	
F	Stabilizer / Bottom rail 15D	1525515	16	20	24					
F	Stabilizer / Bottom rail 24D	1525524				28	32	36		
F	Stabilizer / Bottom rail 30D	1525530							40	
G	Steel bars	11823	2	2	2	2	2	2	2	
H	Wall		1	1	1	1	1	1	1	
I	Screw 12x3/4	V12x34	49	66	86	98	102	113	129	
J	Screw 12x1-1/4S	VHL12X114S	42	53	63	74	84	95	105	
*	Hardware bag/pool	SACV12X34-49	1							
*	Hardware bag/pool	SACV12X34-66		1						
*	Hardware bag/pool	SACV12X34-86			1					
*	Hardware bag/pool	SACV12X34-98				1				
*	Hardware bag/pool	SACV12X34-102					1			
*	Hardware bag/pool	SACV12X34-113						1		
*	Hardware bag/pool	SACV12X34-129							1	
**	Hardware bag/wall	1050000054	1	1	1	1	1	1	1	
***	Hardware bag/pool	SACVHL12114-42	1							
***	Hardware bag/pool	SACVHL12114-53		1						
***	Hardware bag/pool	SACVHL12114-63			1					
***	Hardware bag/pool	SACVHL12114-74				1				
***	Hardware bag/pool	SACVHL12114-84					1			
***	Hardware bag/pool	SACVHL12114-95						1		
***	Hardware bag/pool	SACVHL12114-105							1	
	Thrus phill 18-8 bolts 18-8 1/4-0x3/4	99-0023	31	31	31	31	31	31	31	
	Flange nuts S/S 1/4-20 Serrated	2FGS422	31	31	31	31	31	31	31	
	Instruction DVD	SACWBI36876	1	1	1	1	1	1	1	

* In the hardware bag/pool you will find parts: #V12x34

** In the hardware bag/wall you will find parts: #99-0023 - 2FGS422

*** In the hardware bag/pool you will find parts: #VHL12114S

Section
1

GENERAL INSTRUCTIONS - ROUND POOLS
GROUND PREPARATION

PARTS LISTING - EXPLODED VIEW

Simbio LX RTR
PZENLX-52RSRRRB21
Round

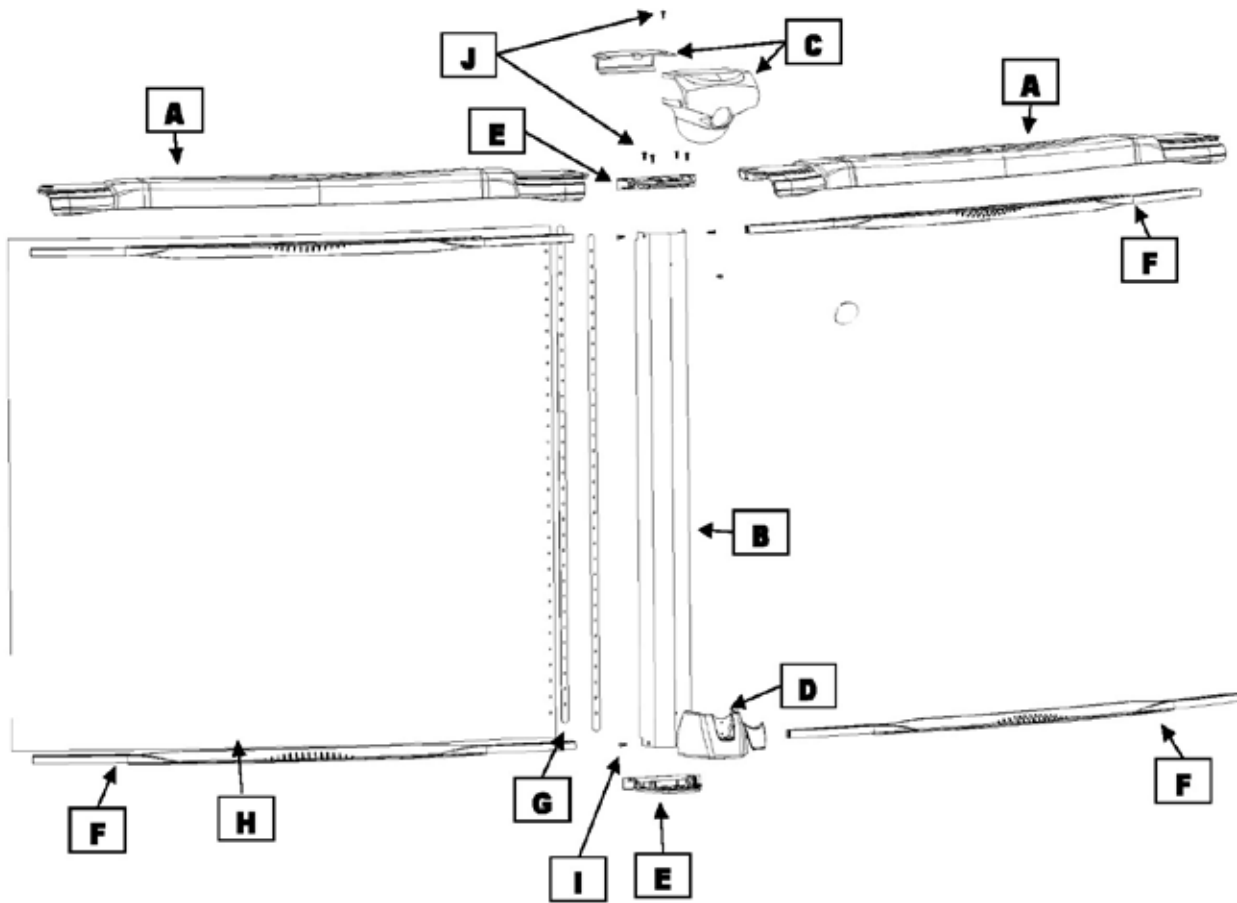

Section 1

GENERAL INSTRUCTIONS - ROUND POOLS GROUND PREPARATION

PARTS LISTING - CONTENT

Product Description :		Simbio LX Round	Revised Sept 2018						
Product Code :		PZENLX-52RSRRRRB21	Quantity required for installation (by pool size)						
Index #	Description	Part #	12	15	18	21	24	27	30
A	Top ledge	AR744-001-R	8	10	12	14	16	18	20
B	Upright	ART711-R12954M	8	10	12	14	16	18	20
C	Ledge cover	CB211-23120ABC	8	10	12	14	16	18	20
D	Foot cover	CB711-23300AC	8	10	12	14	16	18	20
E	Top plate	CG21120A	8	10	12	14	16	18	20
E	Bottom plate	CG21120B	8	10	12	14	16	18	20
F	Stabilizer / Bottom rail 15D	1525515	16	20	24				
F	Stabilizer / Bottom rail 24D	1525524				28	32	36	
F	Stabilizer / Bottom rail 30D	1525530							40
G	Steel bars	11823	2	2	2	2	2	2	2
H	Wall		1	1	1	1	1	1	1
I	Screw 12x3/4	V12x34	58	66	86	98	102	113	129
J	Screw 12x1-1/4S	VHL12X114S	42	53	63	74	84	95	105
*	Hardware bag/pool	SACV12X34-58	1						
*	Hardware bag/pool	SACV12X34-66		1					
*	Hardware bag/pool	SACV12X34-86			1				
*	Hardware bag/pool	SACV12X34-98				1			
*	Hardware bag/pool	SACV12X34-102					1		
*	Hardware bag/pool	SACV12X34-113						1	
*	Hardware bag/pool	SACV12X34-129							1
**	Hardware bag/wall	1050000054	1	1	1	1	1	1	1
***	Hardware bag	SACVHL12114-42	1						
***	Hardware bag	SACVHL12114-53		1					
***	Hardware bag	SACVHL12114-63			1				
***	Hardware bag	SACVHL12114-74				1			
***	Hardware bag	SACVHL12114-84					1		
***	Hardware bag	SACVHL12114-95						1	
***	Hardware bag	SACVHL12114-105							1
	Thrus phill 18-8 bolts 18-8 1/4-0x3/4	99-0023	31	31	31	31	31	31	31
	Flange nuts S/S 1/4-20 Serrated	2FGS422	31	31	31	31	31	31	31
	Instruction DVD	SACWBI36876	1	1	1	1	1	1	1

* In the hardware bag/pool you will find parts: #V12x34

** In the hardware bag/wall you will find parts: #99-0023 - #2FGS422

*** In the hardware bag/pool you will find parts: #VHL12114S

Section
1

GENERAL INSTRUCTIONS - ROUND POOLS
GROUND PREPARATION

PARTS LISTING - EXPLODED VIEW

Simbio RTR
PZEN-54RSPSPSB10
Round

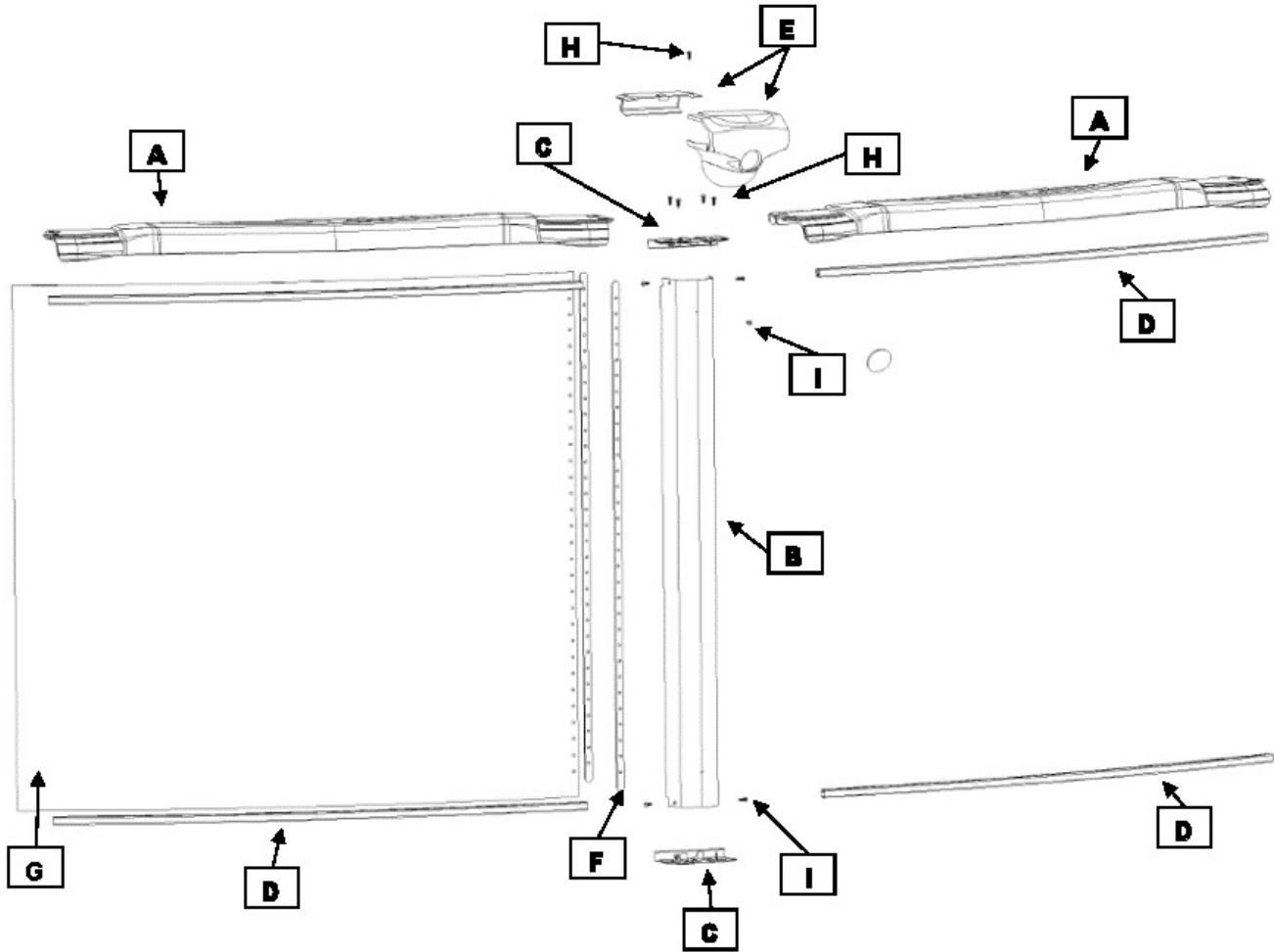

**Section
1**

**GENERAL INSTRUCTIONS - ROUND POOLS
GROUND PREPARATION**

PARTS LISTING - CONTENT

Product Description :		Simbio Round		Revised Sept 2018						
Product Code:		PZEN-54RSPSPSB10								
Index#	Description	Part #	Quantity required for installation (by pool size)							
			12	15	18	21	24	27	30	33
A	Top ledge	AR744-001-R	8	10	12	14	16	18	20	22
B	Upright	ART811-R12954M	8	10	12	14	16	18	20	22
C	Top / Bottom plate	21120A	16	20	24	28	32	36	40	44
D	Stabilizer/Bottom rail	LA1255612	16							
D	Stabilizer/Bottom rail	LA1255615		20						
D	Stabilizer/Bottom rail	LA1255618			24					
D	Stabilizer/Bottom rail	LA1255621				28				
D	Stabilizer/Bottom rail	LA1255624					32			
D	Stabilizer/Bottom rail	LA1255627						36		
D	Stabilizer/Bottom rail	LA1255630							40	44
E	Ledge cover	AR211-23120ABC	8	10	12	14	16	18	20	22
F	Steel bars	11825	2	2	2	2	2	2	2	2
G	Wall		1	1	1	1	1	1	1	1
H	Screw 12x1-1/4S	VHL12X114S	35	42	53	63	74	74	84	95
I	Screw 12x3/4	V12x34	58	66	74	86	98	113	129	147
*	Hardware bag/pool	SACV12X34-58	1							
*	Hardware bag/pool	SACV12X34-66		1						
*	Hardware bag/pool	SACV12X34-74			1					
*	Hardware bag/pool	SACV12X34-86				1				
*	Hardware bag/pool	SACV12X34-98					1			
*	Hardware bag/pool	SACV12X34-113						1		
*	Hardware bag/pool	SACV12X34-129							1	
*	Hardware bag/pool	SACV12X34-147								1
**	Hardware bag/wall	1050000054	1	1	1	1	1	1	1	1
***	Hardware bag/pool	SACVHL12114-35	1							
***	Hardware bag/pool	SACVHL12114-42		1						
***	Hardware bag/pool	SACVHL12114-53			1					
***	Hardware bag/pool	SACVHL12114-63				1				
***	Hardware bag/pool	SACVHL12114-74					1	1		
***	Hardware bag/pool	SACVHL12114-84							1	
***	Hardware bag/pool	SACVHL12114-95								1
	Thrus phill 18-8 bolts 18-8 1/4-0x3/4	99-0023	31	31	31	31	31	31	31	31
	Flange nuts S/S 1/4-20 Serrated	2FGS422	31	31	31	31	31	31	31	31
	Instruction DVD	SACWBI36876	1	1	1	1	1	1	1	1

* In the hardware bag/pool you will find parts: #V12x34

** In the hardware bag/ wall youo will find parts: #99-0023 - 2FGS422

*** In the hardware bag/pool you will find parts: #VHL12114S

Section
1

GENERAL INSTRUCTIONS - ROUND POOLS
GROUND PREPARATION

PARTS LISTING - EXPLODED VIEW

Simbio RTR
PZEN-54RSRARSB11
Round

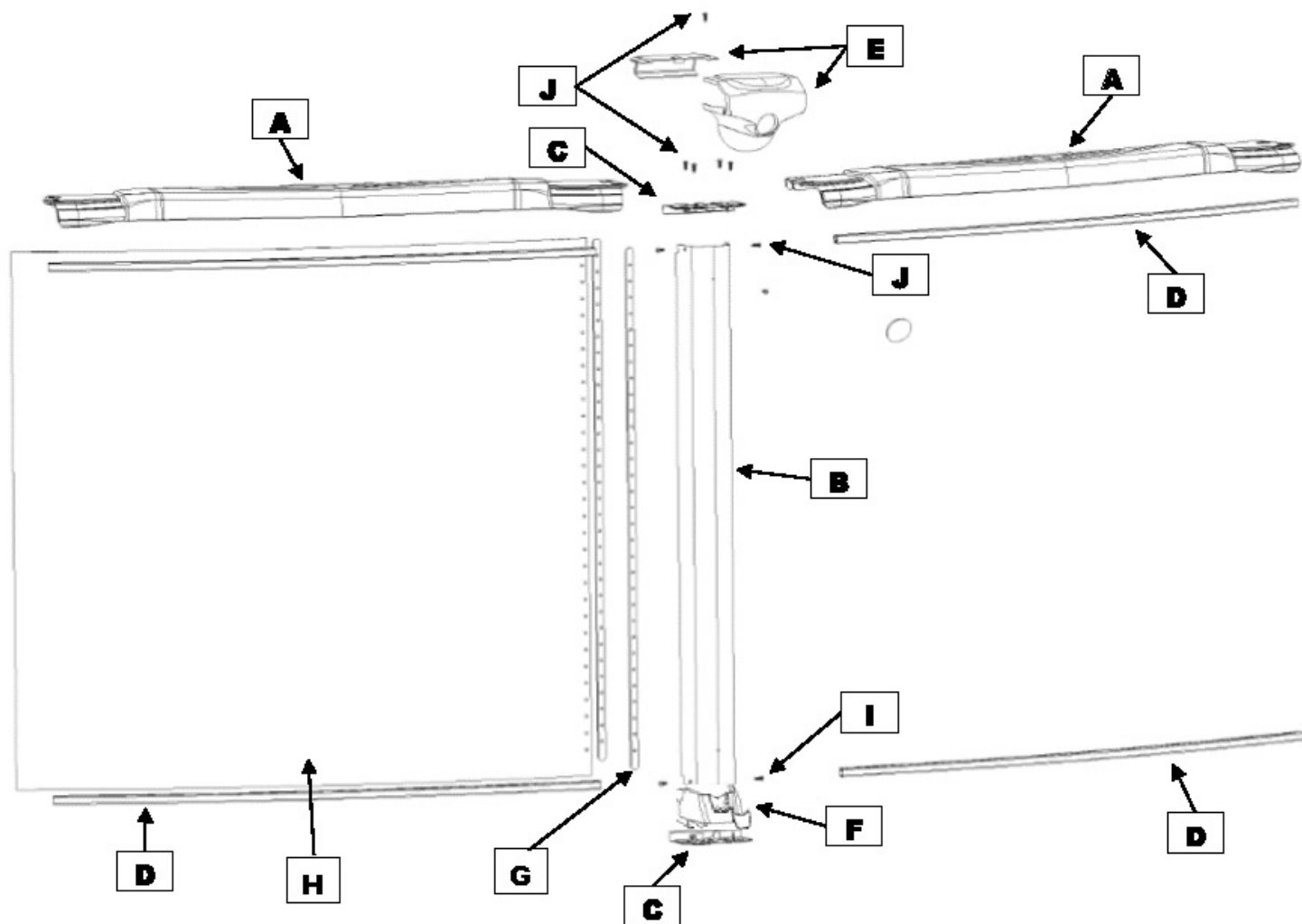

**Section
1**

**GENERAL INSTRUCTIONS - ROUND POOLS
GROUND PREPARATION**

PARTS LISTING - CONTENT

Product Description :		Simbio Round		Revised Sept 2018							
Product Code :		PZEN-54RSRARSB11		Quantity required for installation (by pool size)							
Index#	Description	Part #	12	15	18	21	24	27	30	33	
A	Top ledge	AR744-001-R	8	10	12	14	16	18	20	22	
B	Upright	ART811-R12954M	8	10	12	14	16	18	20	22	
C	Top plate	21120A	8	10	12	14	16	18	20	22	
C	Bottom plate	CG21120B	8	10	12	14	16	18	20	22	
D	Stabilizer	ALU1255612	8								
D	Stabilizer	ALU1255615		10							
D	Stabilizer	ALU1255618			12						
D	Stabilizer	ALU1255621				14					
D	Stabilizer	ALU1255624					16				
D	Stabilizer	ALU1255627						18			
D	Stabilizer	ALU1255630							20	22	
D	Bottom rail	1525515	8	10							
D	Bottom rail	1525524			12	14	16	18			
D	Bottom rail	1525530							20	22	
E	Ledge cover	AR211-23120ABC	8	10	12	14	16	18	20	22	
F	Foot cover	AR711-23300AC	8	10	12	14	16	18	20	22	
G	Steel bars	11825	2	2	2	2	2	2	2	2	
H	Wall		1	1	1	1	1	1	1	1	
I	Screw 12x3/4	V12x34	58	74	86	102	124	129	147	164	
J	Screw 12x1-1/4S	VHL12X1145	35	42	53	63	74	74	84	95	
*	Hardware bag/pool	SACV12X34-58	1								
*	Hardware bag/pool	SACV12X34-74		1							
*	Hardware bag/pool	SACV12X34-86			1						
*	Hardware bag/pool	SACV12X34-102				1					
*	Hardware bag/pool	SACV12X34-124					1				
*	Hardware bag/pool	SACV12X34-129						1			
*	Hardware bag/pool	SACV12X34-147							1		
*	Hardware bag/pool	SACV12X34-164								1	
**	Hardware bag/wall	1050000054	1	1	1	1	1	1	1	1	
***	Hardware bag/pool	SACVHL12114-35	1								
***	Hardware bag/pool	SACVHL12114-42		1							
***	Hardware bag/pool	SACVHL12114-53			1						
***	Hardware bag/pool	SACVHL12114-63				1					
***	Hardware bag/pool	SACVHL12114-74					1	1			
***	Hardware bag/pool	SACVHL12114-84							1		
***	Hardware bag/pool	SACVHL12114-95								1	
	Thrus phill 18-8 bolts 18-8 1/4-0x3/4	99-0023	31	31	31	31	31	31	31	31	
	Flange nuts S/S 1/4-20 Serrated	2FGS422	31	31	31	31	31	31	31	31	
	Instruction DVD	SACWBI36876	1	1	1	1	1	1	1	1	

* In the hardware bag/pool you will find parts: #V12x34

** In the hardware bag/wall you will find parts: #99-0023 - #2FGS422

*** In the hardware bag/pool you will find parts: #VHL121145

Section
1

GENERAL INSTRUCTIONS - ROUND POOLS
GROUND PREPARATION

PARTS LISTING - EXPLODED VIEW

Simbio RTR
PZEN-54RSRSRB11
Round

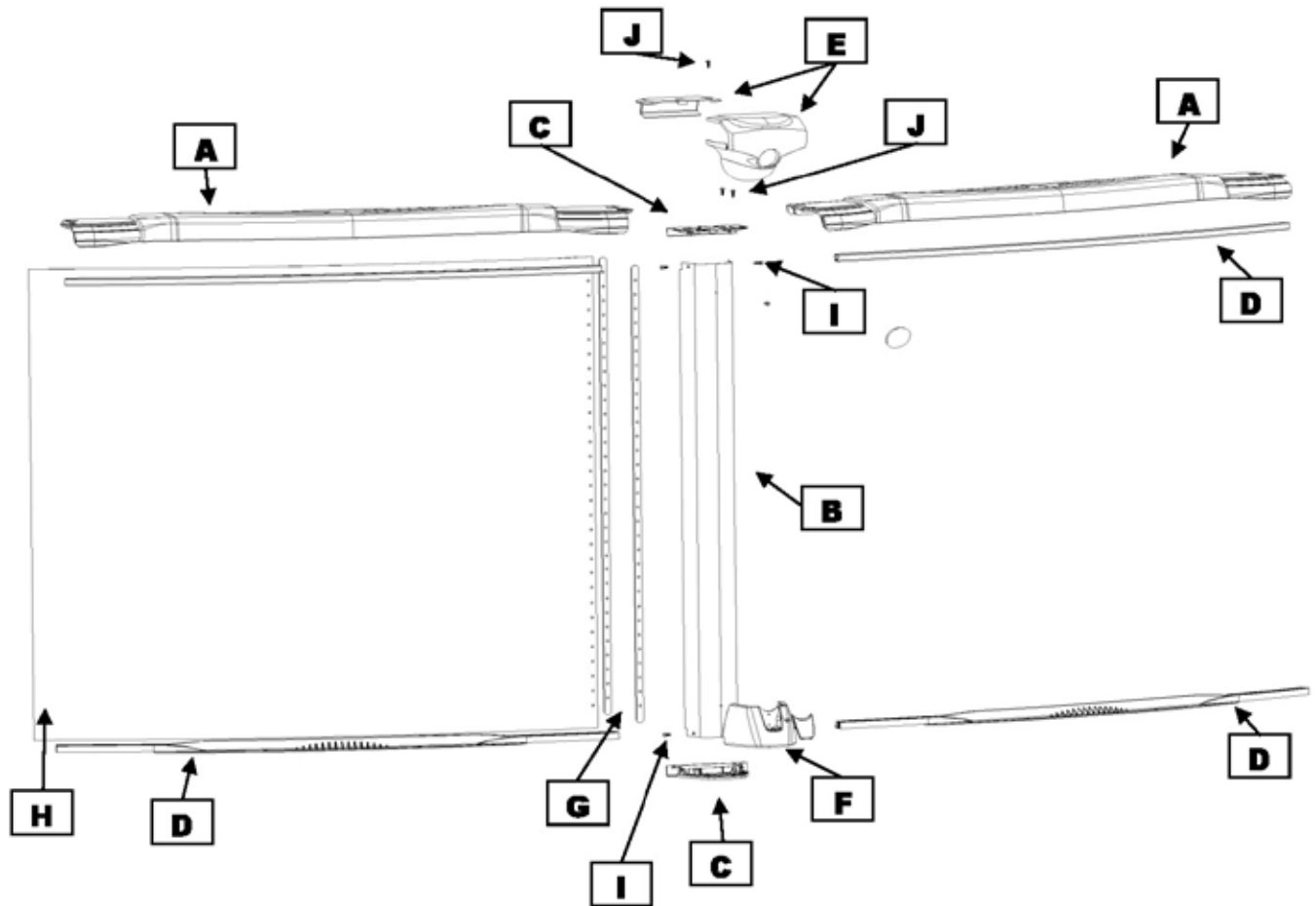

**Section
1**

**GENERAL INSTRUCTIONS - ROUND POOLS
GROUND PREPARATION**

PARTS LISTING - CONTENT

Product Description :		Simbio Round		Revised Sept 2018							
Product Code :		PZEN-54RSRSRB11									
Index#	Description	Part #	Quantity required for installation (by pool size)								
			12	15	18	21	24	27	30	33	
A	Top ledge	AR744-001-R	8	10	12	14	16	18	20	22	
B	Upright	ART811-R12954M	8	10	12	14	16	18	20	22	
C	Top plate	21120A	8	10	12	14	16	18	20	22	
C	Bottom plate	CG21120B	8	10	12	14	16	18	20	22	
D	Stabilizer	LA1255612	8								
D	Stabilizer	LA1255615		10							
D	Stabilizer	LA1255618			12						
D	Stabilizer	LA1255621				14					
D	Stabilizer	LA1255624					16				
D	Stabilizer	LA1255627						18			
D	Stabilizer	LA1255630							20	22	
D	Bottom rail	1525515	8	10	12						
D	Bottom rail	1525524				14	16	18			
D	Bottom rail	1525530							20	22	
E	Ledge cover	AR211-23120ABC	8	10	12	14	16	18	20	22	
F	Foot cover	AR711-23300AC	8	10	12	14	16	18	20	22	
G	Steel bars	11825	2	2	2	2	2	2	2	2	
H	Wall		1	1	1	1	1	1	1	1	
I	Screw 12x3/4	V12x34	58	74	86	98	113	129	140	156	
J	Screw 12x1-1/4S	VHL12X114S	35	42	53	63	70	74	84	88	
*	Hardware bag/pool	SACV12X34-58	1							1	
*	Hardware bag/pool	SACV12X34-66							1		
*	Hardware bag/pool	SACV12X34-74		1					1		
*	Hardware bag/pool	SACV12X34-86			1						
*	Hardware bag/pool	SACV12X34-98				1				1	
*	Hardware bag/pool	SACV12X34-113					1				
*	Hardware bag/pool	SACV12X34-129						1			
**	Hardware bag/wall	1050000054	1	1	1	1	1	1	1	1	
***	Hardware bag/pool	SACVHL12114-35	1				2			1	
***	Hardware bag/pool	SACVHL12114-42		1							
***	Hardware bag/pool	SACVHL12114-53			1					1	
***	Hardware bag/pool	SACVHL12114-63				1					
***	Hardware bag/pool	SACVHL12114-74						1			
***	Hardware bag/pool	SACVHL12114-84							1		
	Thrus phill 18-8 bolts 18-8 1/4-0x3/4	99-0023	31	31	31	31	31	31	31	31	
	Flange nuts S/S 1/4-20 Serrated	2FGS422	31	31	31	31	31	31	31	31	
	Instruction DVD	SACWBI36876	1	1	1	1	1	1	1	1	

* In the hardware bag/pool you will find parts: #V12x34

** In the hardware bag/wall you will find parts: #99-0023 - #2FGS422

*** In the hardware bag/pool you will find parts: #VHL12114S

Section
1

GENERAL INSTRUCTIONS - ROUND POOLS
GROUND PREPARATION

PARTS LISTING - EXPLODED VIEW

Vectra RTR
PZEN-52RSPSPSB10
Round

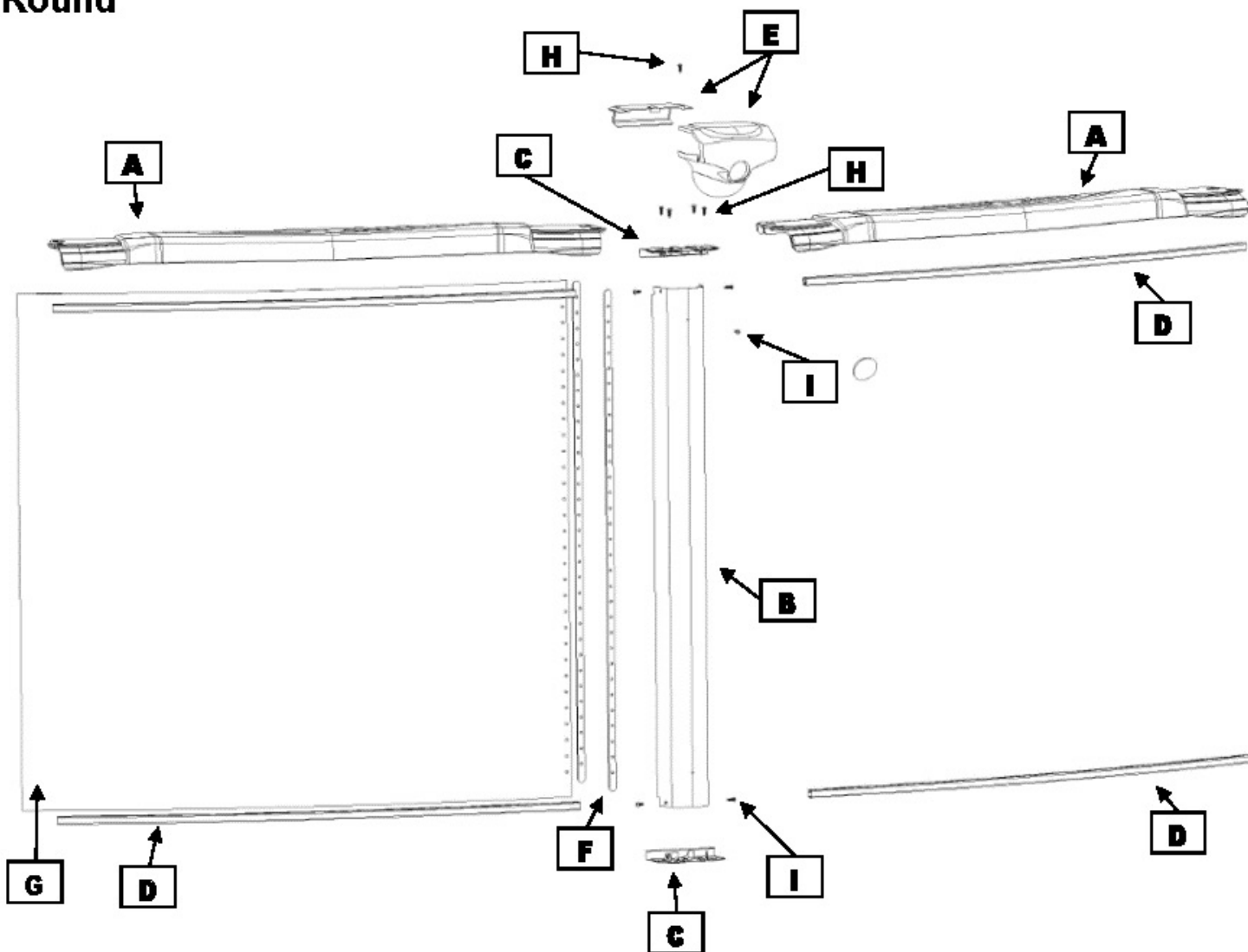

Section 1

GENERAL INSTRUCTIONS - ROUND POOLS GROUND PREPARATION

PARTS LISTING - CONTENT

Product Description :		Vectra Round		Revised Sept 2018							
Product Code:		PZEN-52RSPSPSB10									
Index#	Description	Part #	Quantity required for installation (by pool size)								
			12	15	18	21	24	27	30	33	
A	Top ledge	AR744-001-R	8	10	12	14	16	18	20	22	
B	Upright	ART711-R12954M	8	10	12	14	16	18	20	22	
C	Top / Bottom plate	21120A	16	20	24	28	32	36	40	44	
D	Stabilizer/Bottom rail	LA1255612	16								
D	Stabilizer/Bottom rail	LA1255615		20							
D	Stabilizer/Bottom rail	LA1255618			24						
D	Stabilizer/Bottom rail	LA1255621				28					
D	Stabilizer/Bottom rail	LA1255624					32				
D	Stabilizer/Bottom rail	LA1255627						36			
D	Stabilizer/Bottom rail	LA1255630							40	44	
E	Ledge cover	AR211-23120ABC	8	10	12	14	16	18	20	22	
F	Steel bars	11823	2	2	2	2	2	2	2	2	
G	Wall		1	1	1	1	1	1	1	1	
H	Screw 12x1-1/4S	VHL12X114S	35	42	53	63	74	74	84	95	
I	Screw 12x3/4	V12x34	58	66	74	86	98	113	129	147	
*	Hardware bag/pool	SACV12X34-58	1								
*	Hardware bag/pool	SACV12X34-66		1							
*	Hardware bag/pool	SACV12X34-74			1						
*	Hardware bag/pool	SACV12X34-86				1					
*	Hardware bag/pool	SACV12X34-98					1				
*	Hardware bag/pool	SACV12X34-113						1			
*	Hardware bag/pool	SACV12X34-129							1		
*	Hardware bag/pool	SACV12X34-147								1	
**	Hardware bag/wall	1050000054	1	1	1	1	1	1	1	1	
***	Hardware bag/pool	SACVHL12114-35	1								
***	Hardware bag/pool	SACVHL12114-42		1							
***	Hardware bag/pool	SACVHL12114-53			1						
***	Hardware bag/pool	SACVHL12114-63				1					
***	Hardware bag/pool	SACVHL12114-74					1	1			
***	Hardware bag/pool	SACVHL12114-84							1		
***	Hardware bag/pool	SACVHL12114-95								1	
	Thru phill 18-8 bolts 18-8 1/4-0x3/4	99-0023	31	31	31	31	31	31	31	31	
	Flange nuts S/S 1/4-20 Serrated	2FGS422	31	31	31	31	31	31	31	31	
	Instruction DVD	SACWBI36876	1	1	1	1	1	1	1	1	

* In the hardware bag/pool you will find parts: #V12x34

** In the hardware bag/ wall you will find parts: #99-0023 - 2FGS422

*** In the hardware bag/pool you will find parts: #VHL12114S

Section
1

GENERAL INSTRUCTIONS - ROUND POOLS
GROUND PREPARATION

PARTS LISTING - EXPLODED VIEW

Vectra RTR
PZEN-54RSPSPSB10
Round

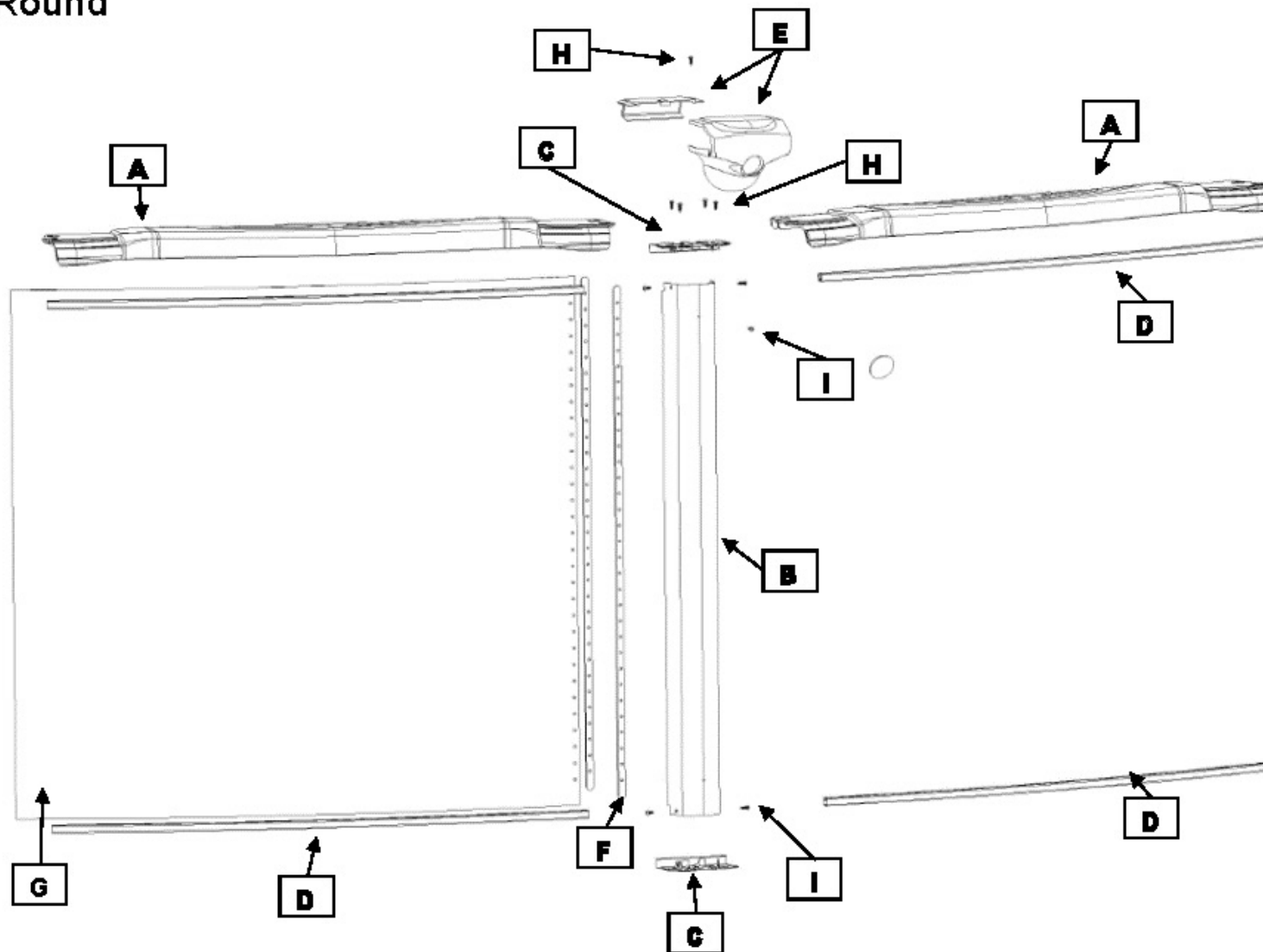

Section 1

GENERAL INSTRUCTIONS - ROUND POOLS GROUND PREPARATION

PARTS LISTING - CONTENT

Product Description :			Vectra Round								Revised Sept 2018
Product Code:			PZEN-54RSPSPSB10								
Index#	Description	Part #	Quantity required for installation (by pool size)								
			12	15	18	21	24	27	30	33	
A	Top ledge	AR744-001-R	8	10	12	14	16	18	20	22	
B	Upright	ART811-R12954M	8	10	12	14	16	18	20	22	
C	Top / Bottom plate	21120A	16	20	24	28	32	36	40	44	
D	Stabilizer/Bottom rail	LA1255612	16								
D	Stabilizer/Bottom rail	LA1255615		20							
D	Stabilizer/Bottom rail	LA1255618			24						
D	Stabilizer/Bottom rail	LA1255621				28					
D	Stabilizer/Bottom rail	LA1255624					32				
D	Stabilizer/Bottom rail	LA1255627						36			
D	Stabilizer/Bottom rail	LA1255630							40	44	
E	Ledge cover	AR211-23120ABC	8	10	12	14	16	18	20	22	
F	Steel bars	11825	2	2	2	2	2	2	2	2	
G	Wall		1	1	1	1	1	1	1	1	
H	Screw 12x1-1/4S	VHL12X114S	35	42	53	63	74	74	84	95	
I	Screw 12x3/4	V12x34	58	66	74	86	98	113	129	147	
*	Hardware bag/pool	SACV12X34-58	1								
*	Hardware bag/pool	SACV12X34-66		1							
*	Hardware bag/pool	SACV12X34-74			1						
*	Hardware bag/pool	SACV12X34-86				1					
*	Hardware bag/pool	SACV12X34-98					1				
*	Hardware bag/pool	SACV12X34-113						1			
*	Hardware bag/pool	SACV12X34-129							1		
*	Hardware bag/pool	SACV12X34-147								1	
**	Hardware bag/wall	1050000054	1	1	1	1	1	1	1	1	
***	Hardware bag/pool	SACVHL12114-35	1								
***	Hardware bag/pool	SACVHL12114-42		1							
***	Hardware bag/pool	SACVHL12114-53			1						
***	Hardware bag/pool	SACVHL12114-63				1					
***	Hardware bag/pool	SACVHL12114-74					1	1			
***	Hardware bag/pool	SACVHL12114-84							1		
***	Hardware bag/pool	SACVHL12114-95								1	
	Thrus phill 18-8 bolts 18-8 1/4-0x3/4	99-0023	31	31	31	31	31	31	31	31	
	Flange nuts S/S 1/4-20 Serrated	2FGS422	31	31	31	31	31	31	31	31	
	Instruction DVD	SACWBI36876	1	1	1	1	1	1	1	1	

* In the hardware bag/pool you will find parts: #V12x34

** In the hardware bag/ wall you will find parts: #99-0023 - 2FGS422

*** In the hardware bag/pool you will find parts: #VHL12114S

Section
1

GENERAL INSTRUCTIONS - ROUND POOLS
GROUND PREPARATION

PARTS LISTING - EXPLODED VIEW

Sovana RTR
PSOV-52RSRRRRB41
Round

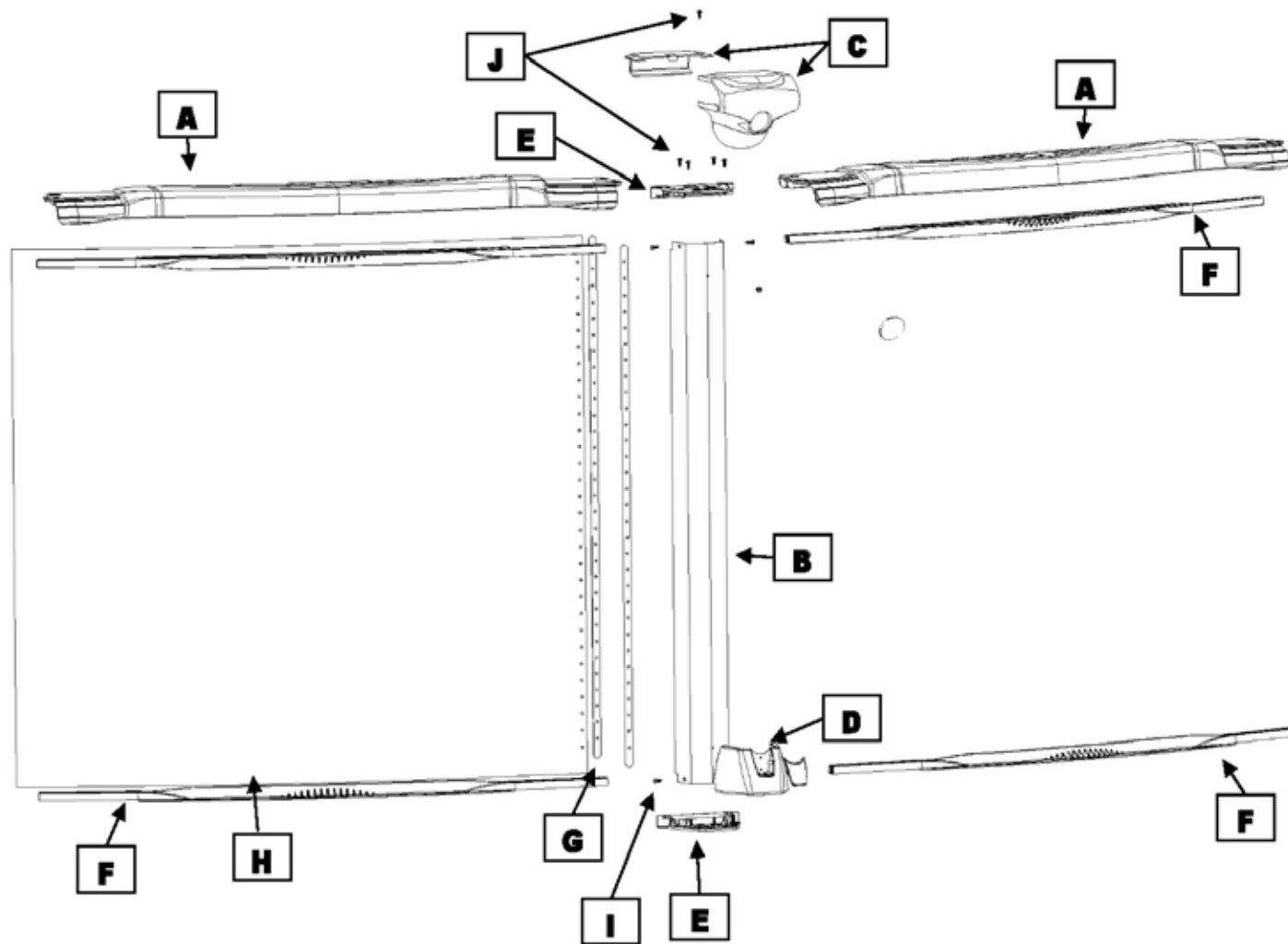

**Section
1**

**GENERAL INSTRUCTIONS - ROUND POOLS
GROUND PREPARATION**

PARTS LISTING - CONTENT

Product Description :		Sovana Round		Revised Sept 2018					
Product Code :		PSOV-52RSRRRB11							
			Quantity required for installation (by pool size)						
Index #	Description	Part #	12	15	18	21	24	27	30
A	Top ledge	AR744-001-R	8	10	12	14	16	18	20
B	Upright	MOT735-R12954M	8	10	12	14	16	18	20
C	Ledge cover	CB211-23120ABC	8	10	12	14	16	18	20
D	Foot cover	CB711-23300AC	8	10	12	14	16	18	20
E	Top plate	CG21120A	8	10	12	14	16	18	20
E	Bottom plate	CG21120B	8	10	12	14	16	18	20
F	Stabilizer / Bottom rail 15D	1525515	16	20	24				
F	Stabilizer / Bottom rail 24D	1525524				28	32	36	
F	Stabilizer / Bottom rail 30D	1525530							40
G	Steel bars	11823	2	2	2	2	2	2	2
H	Wall		1	1	1	1	1	1	1
I	Screw 12x3/4	V12x34	58	66	86	98	102	113	129
J	Screw 12x1-1/4S	VHL12X114S	42	53	63	74	84	95	105
*	Hardware bag/pool	SACV12X34-58	1						
*	Hardware bag/pool	SACV12X34-66		1					
*	Hardware bag/pool	SACV12X34-86			1				
*	Hardware bag/pool	SACV12X34-98				1			
*	Hardware bag/pool	SACV12X34-102					1		
*	Hardware bag/pool	SACV12X34-113						1	
*	Hardware bag/pool	SACV12X34-129							1
**	Hardware bag/wall	1050000054	1	1	1	1	1	1	1
***	Hardware bag/pool	SACVHL12114-42	1						
***	Hardware bag/pool	SACVHL12114-53		1					
***	Hardware bag/pool	SACVHL12114-63			1				
***	Hardware bag/pool	SACVHL12114-74				1			
***	Hardware bag/pool	SACVHL12114-84					1		
***	Hardware bag/pool	SACVHL12114-95						1	
***	Hardware bag/pool	SACVHL12114-105							1
	Thrussh phill 18-8 bolts 18-8 1/4-0x3/4	99-0023	31	31	31	31	31	31	31
	Flange nuts S/S 1/4-20 Serrated	2FGS422	31	31	31	31	31	31	31
	Instruction DVD	SACWBI36876	1	1	1	1	1	1	1

* In the hardware bag/pool you will find parts: #V12x34

** In the hardware bag/wall you will find parts: #99-0023 - 2FGS422

*** In the hardware bag/pool you will find parts: #VHL12114S

Section
1

GENERAL INSTRUCTIONS - ROUND POOLS
GROUND PREPARATION

PARTS LISTING - EXPLODED VIEW

Sovana STR
PSOV-52SSPSPSB40

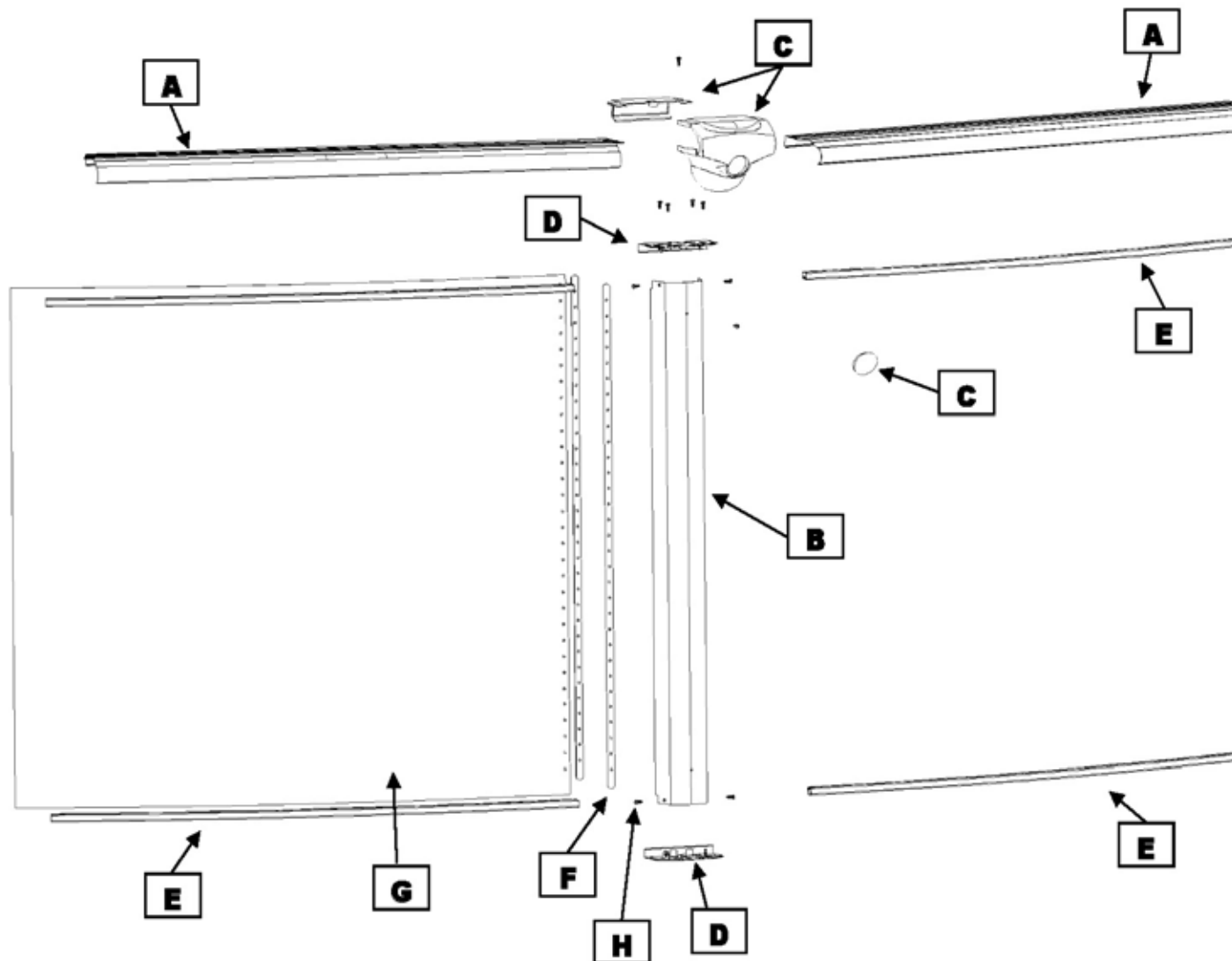

Section 1

GENERAL INSTRUCTIONS - ROUND POOLS GROUND PREPARATION

PARTS LISTING - CONTENT

Product Description:		Sovana Round	Revised Sept 2018									
Product Code :		PSOV-52SSPSPSB40										
Index #	Description	Part #	Quantity required for installation (by pool size)									
			8	12	15	18	21	24	27	30		
A	Top ledge 30"	ART211-1295030	10									
A	Top ledge 50"	ART211-1295050		9								
A	Top ledge 52"	ART211-1295052			11	13						
A	Top ledge 53"	ART211-1295053						15	17	19	21	
B	Upright (52)	MOT735-R12954M	10	9	11	13	15	17	19	21		
C	Ledge cover	CB211-23120ABC	10	9	11	13	15	17	19	21		
D	Bottom/Top plate	21120A	20	18	22	26	30	34	38	42		
E	Stabilizer/Bottom Rail	LA1254108	20									
E	Stabilizer/Bottom Rail	LA1254112		18								
E	Stabilizer/Bottom Rail	LA1254115			22							
E	Stabilizer/Bottom Rail	LA1254118				26						
E	Stabilizer/Bottom Rail	LA1254121					30					
E	Stabilizer/Bottom Rail	LA1254124						34				
E	Stabilizer/Bottom Rail	LA1254127								38		
E	Stabilizer/Bottom Rail	LA1255330										42
F	Steel bars	11823	2	2	2	2	2	2	2	2	2	2
G	Wall		1	1	1	1	1	1	1	1	1	1
H	Screw 12x3/4	V12x34	113	113	113	133	153	174	194	214		
*	Hardware bag/pool	SACV12X34-113	1	1	1							
*	Hardware bag/pool	SACV12X34-133				1						
*	Hardware bag/pool	SACV12X34-153					1					
*	Hardware bag/pool	SACV12X34-174						1				
*	Hardware bag/pool	SACV12X34-194							1			
*	Hardware bag/pool	SACV12X34-214									1	
**	Hardware bag/wall	1050000054	1	1	1	1	1	1	1	1	1	1
	Thru phill 18-8 bolts 18-8 1/4-0x3/4	99-0023	31	31	31	31	31	31	31	31	31	31
	Flange nuts S/S 1/4-20 Serrated	2FGS422	31	31	31	31	31	31	31	31	31	31
	Instruction DVD	SACWBI36876	1	1	1	1	1	1	1	1	1	1

* In the hardware bag/pool you will find parts: #V12x34

** In the hardware bag/wall you will find parts: #99-0023 - 2FGS422

Section
1

GENERAL INSTRUCTIONS - ROUND POOLS
GROUND PREPARATION

PARTS LISTING - EXPLODED VIEW

Murano RTR
PMUR-52RSRRRRB31
Round

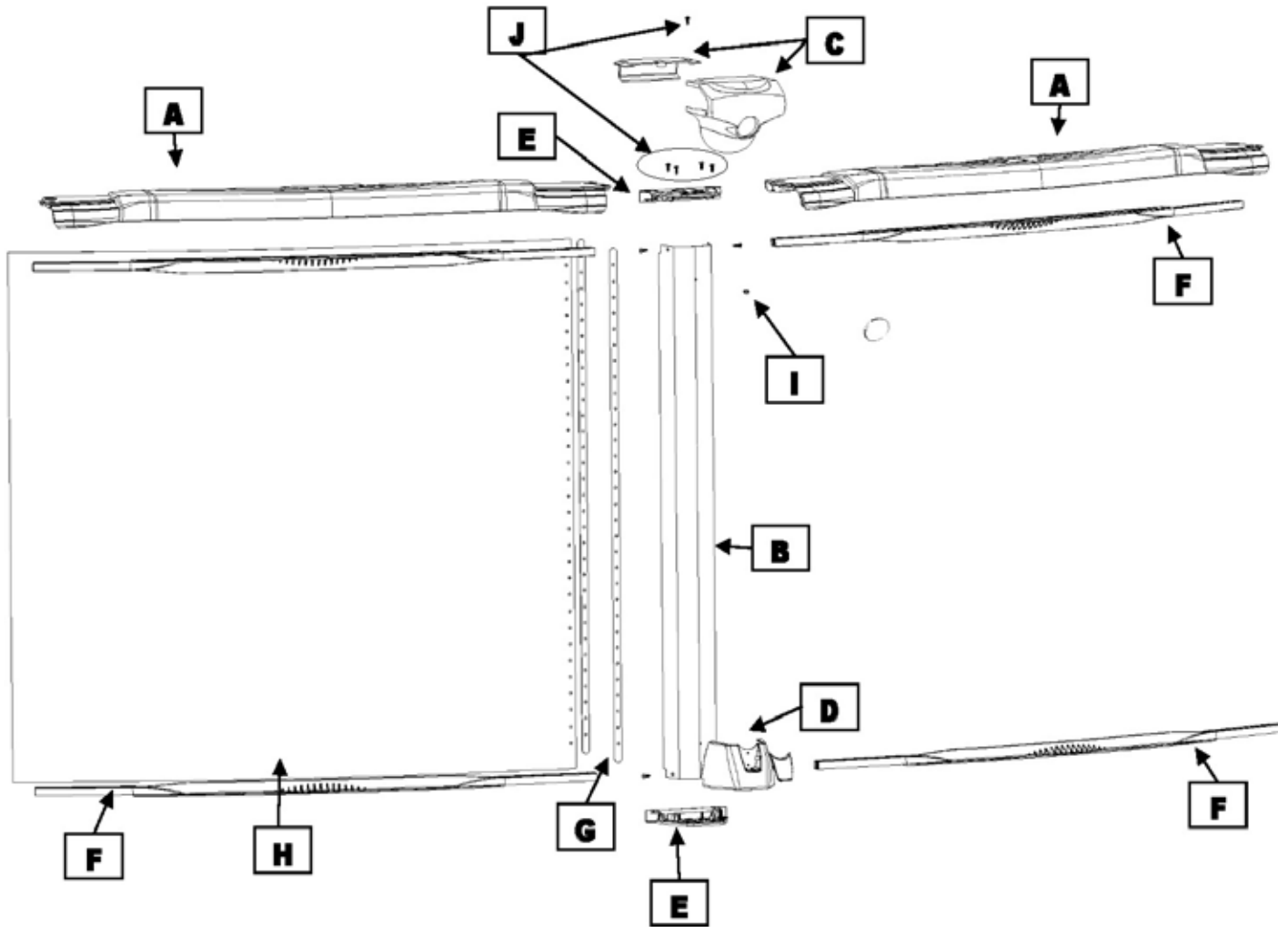

Section 1

GENERAL INSTRUCTIONS - ROUND POOLS GROUND PREPARATION

PARTS LISTING - CONTENT

Product Description :		Murano Round		Revised Sept 2018							
Product Code :		PMUR-52RSRRRB31									
Index #	Description	Part #	Quantity required for installation (by pool size)								
			12	15	18	21	24	27	30	33	
A	Top ledge	PP744-001-R	8	10	12	14	16	18	20	22	
B	Upright	MOT735-R12954M	8	10	12	14	16	18	20	22	
C	Ledge cover	CB211-23120ABC	8	10	12	14	16	18	20	22	
D	Foot cover	CB711-23300AC	8	10	12	14	16	18	20	22	
E	Top plate	CG21120A	8	10	12	14	16	18	20	22	
E	Bottom plate	CG21120B	8	10	12	14	16	18	20	22	
F	Stabilizer / Bottom rail 15D	1525515	16	20	24						
F	Stabilizer / Bottom rail 24D	1525524				28	32	36			
F	Stabilizer / Bottom rail 30D	1525530							40	44	
G	Steel bars	11823	2	2	2	2	2	2	2	2	
H	Wall		1	1	1	1	1	1	1	1	
I	Screw 12x3/4	V12x34	49	62	74	86	98	111	120	133	
J	Screw 12x1-1/4S	VHL12X114S	42	53	63	74	84	90	100	110	
*	Hardware bag/pool	SACV12X34-20							1		
*	Hardware bag/pool	SACV12X34-25						1			
*	Hardware bag/pool	SACV12X34-49	1								
*	Hardware bag/pool	SACV12X34-62		1							
*	Hardware bag/pool	SACV12X34-74			1						
*	Hardware bag/pool	SACV12X34-86				1		1			
*	Hardware bag/pool	SACV12X34-98					1				
*	Hardware bag/pool	SACV12X34-100							1		
*	Hardware bag/pool	SACV12X34-133								1	
**	Hardware bag/wall	1050000054	1	1	1	1	1	1	1	1	
***	Hardware bag/pool	SACVHL12114-16						1			
***	Hardware bag/pool	SACVHL12114-20							5		
***	Hardware bag/pool	SACVHL12114-22								5	
***	Hardware bag/pool	SACVHL12114-42	1								
***	Hardware bag/pool	SACVHL12114-53		1							
***	Hardware bag/pool	SACVHL12114-63			1						
***	Hardware bag/pool	SACVHL12114-74				1		1			
***	Hardware bag/pool	SACVHL12114-84					1				
***	Hardware bag/pool	SACVHL12114-95									
***	Hardware bag/pool	SACVHL12114-105									
	Thru phill 18-8 bolts 18-8 1/4-0x3/4	99-0023	31	31	31	31	31	31	31	31	
	Flange nuts S/S 1/4-20 Serrated	2FGS422	31	31	31	31	31	31	31	31	
	Instruction DVD	SACWBI36876	1	1	1	1	1	1	1	1	

* In the hardware bag/pool you will find parts: #V12x34

** In the hardware bag/wall you will find parts: #99-0023 - 2FGS422

*** In the hardware bag/pool you will find parts: #VHL12114S

Section
1

GENERAL INSTRUCTIONS - ROUND POOLS
GROUND PREPARATION

PARTS LISTING - EXPLODED VIEW

Murano RTR
PMUR-54RSRRRRB31
Round

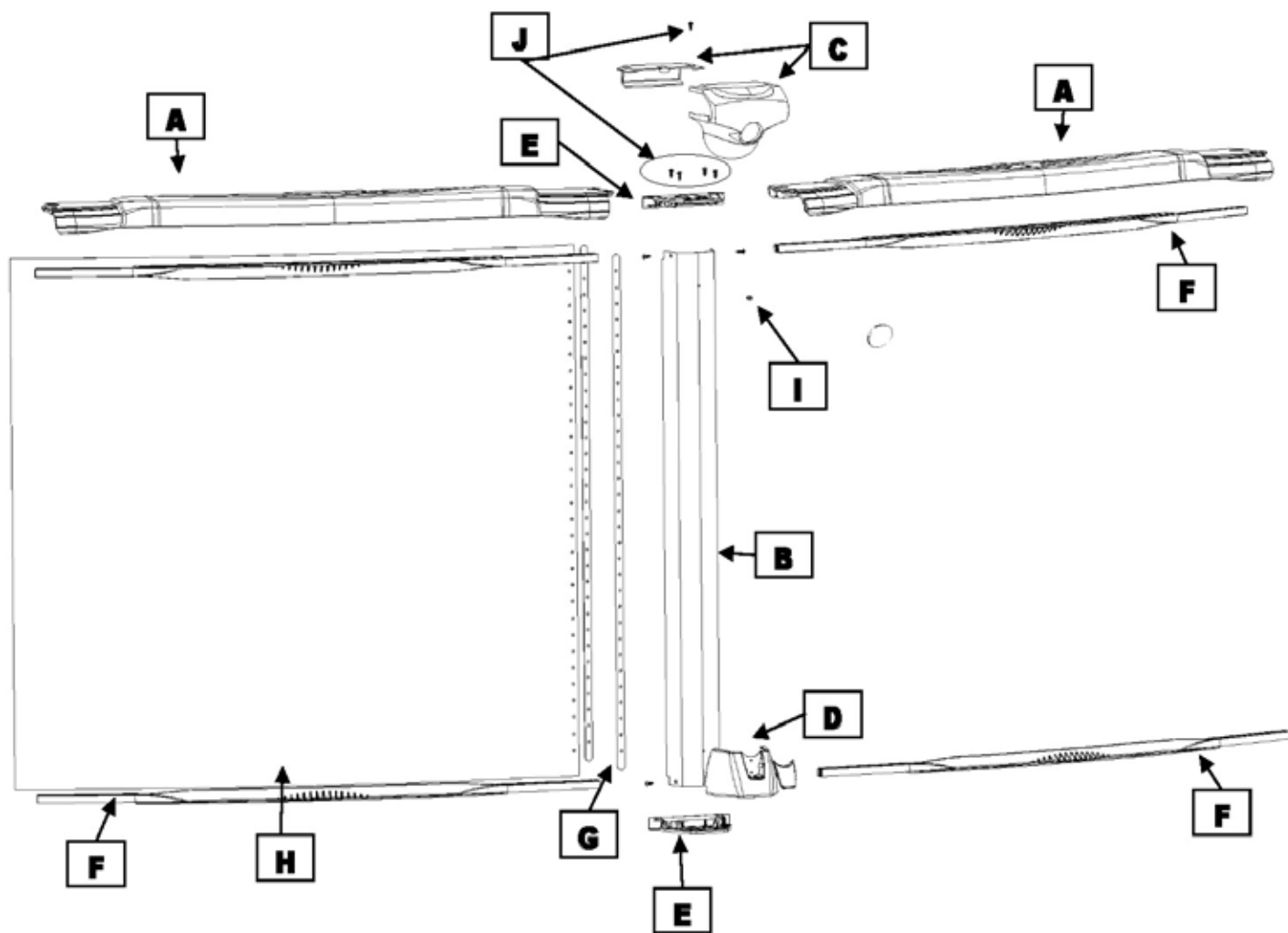

**Section
1**

**GENERAL INSTRUCTIONS - ROUND POOLS
GROUND PREPARATION**

PARTS LISTING - CONTENT

Product Description :		Murano Round	Revised Sept 2018							
Product Code :		PMUR-54RSRRRRB31								
Index #	Description	Part #	Quantity required for installation (by pool size)							
			12	15	18	21	24	27	30	33
A	Top ledge	PP744-001-R	8	10	12	14	16	18	20	22
B	Upright	MOT811-R12954M	8	10	12	14	16	18	20	22
C	Ledge cover	CB211-23120ABC	8	10	12	14	16	18	20	22
D	Foot cover	CB711-23300AC	8	10	12	14	16	18	20	22
E	Top plate	CG21120A	8	10	12	14	16	18	20	22
E	Bottom plate	CG21120B	8	10	12	14	16	18	20	22
F	Stabilizer / Bottom rail 15D	1525515	16	20	24					
F	Stabilizer / Bottom rail 24D	1525524				28	32	36		
F	Stabilizer / Bottom rail 30D	1525530							40	44
G	Steel bars	11825	2	2	2	2	2	2	2	2
H	Wall		1	1	1	1	1	1	1	1
I	Screw 12x3/4	V12x34	49	62	74	86	98	111	120	133
J	Screw 12x1-1/4S	VHL12X114S	42	53	63	74	84	90	100	110
*	Hardware bag/pool	SACV12X34-20							1	
*	Hardware bag/pool	SACV12X34-25						1		
*	Hardware bag/pool	SACV12X34-49	1							
*	Hardware bag/pool	SACV12X34-62		1						
*	Hardware bag/pool	SACV12X34-74			1					
*	Hardware bag/pool	SACV12X34-86				1		1		
*	Hardware bag/pool	SACV12X34-98					1			
*	Hardware bag/pool	SACV12X34-100							1	
*	Hardware bag/pool	SACV12X34-133								1
**	Hardware bag/wall	1050000054	1	1	1	1	1	1	1	1
***	Hardware bag/pool	SACVHL12114-16						1		
***	Hardware bag/pool	SACVHL12114-20							5	
***	Hardware bag/pool	SACVHL12114-22								5
***	Hardware bag/pool	SACVHL12114-42	1							
***	Hardware bag/pool	SACVHL12114-53		1						
***	Hardware bag/pool	SACVHL12114-63			1					
***	Hardware bag/pool	SACVHL12114-74				1		1		
***	Hardware bag/pool	SACVHL12114-84					1			
***	Hardware bag/pool	SACVHL12114-95								
***	Hardware bag/pool	SACVHL12114-105								
	Thrust phill 18-8 bolts 18-8 1/4-0x3/4	99-0023	31	31	31	31	31	31	31	31
	Flange nuts S/S 1/4-20 Serrated	2FGS422	31	31	31	31	31	31	31	31
	Instruction DVD	SACWBI36876	1	1	1	1	1	1	1	1

* In the hardware bag/pool you will find parts: #V12x34

** In the hardware bag/wall you will find parts: #99-0023 - 2FGS422

*** In the hardware bag/pool you will find parts: #VHL12114S

Section
1

GENERAL INSTRUCTIONS - ROUND POOLS
GROUND PREPARATION

PARTS LISTING - EXPLODED VIEW

Magnus RTR
PMAG-54RSRRSB10
Round

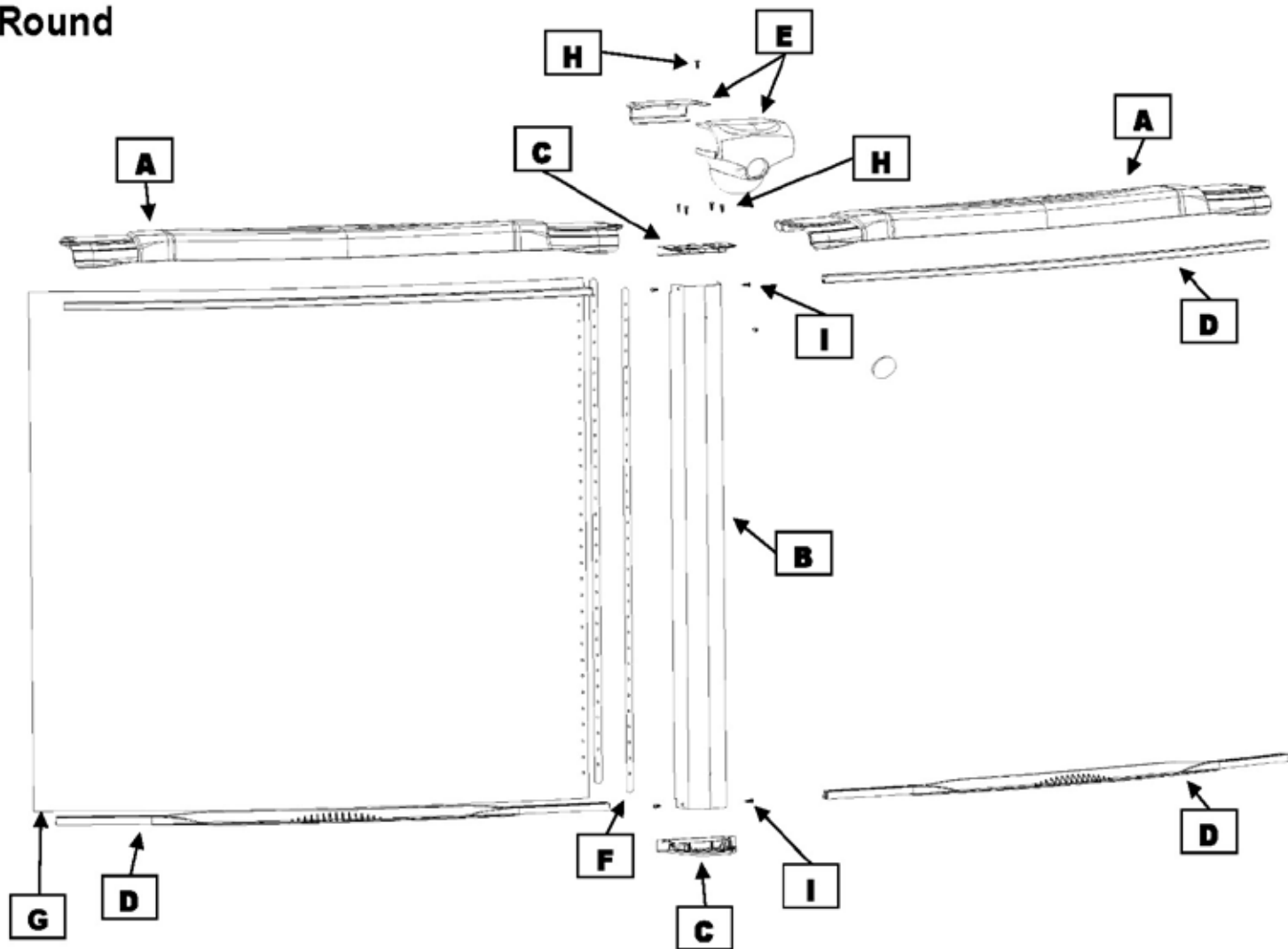

Section 1

GENERAL INSTRUCTIONS - ROUND POOLS GROUND PREPARATION

PARTS LISTING - CONTENT

Product Description :		Magnus Round	Revised Sept 2018							
Product Code :		PMAG-54RSRSRSB10								
Index#	Description	Parts #	Quantity required for installation (by pool size)							
			12	15	18	21	24	27	30	33
A	Top ledge	AR744-001-R	8	10	12	14	16	18	20	22
B	Upright	ART811-R12954M	8	10	12	14	16	18	20	22
C	Top plate	21120A	8	10	12	14	16	18	20	22
C	Bottom plate	CG21120B	8	10	12	14	16	18	20	22
D	Stabilizer	LA1255612	8							
D	Stabilizer	LA1255615		10						
D	Stabilizer	LA1255618			12					
D	Stabilizer	LA1255621				14				
D	Stabilizer	LA1255624					16			
D	Stabilizer	LA1255627						18		
D	Stabilizer	LA1255630							20	22
D	Bottom rail	1525515	8	10						
D	Bottom rail	1525524			12	14	16	18		
D	Bottom rail	1525530							20	22
E	Ledge cover	AR211-23120ABC	8	10	12	14	16	18	20	22
F	Steel bars	11825	2	2	2	2	2	2	2	2
G	Wall		1	1	1	1	1	1	1	1
H	Screw 12x1-1/4S	VHL12x114S	35	42	53	63	74	74	84	95
I	Screw 12x3/4	V12x34	58	66	74	86	98	113	129	147
*	Hardware bag/pool	SACV12X34-58	1							
*	Hardware bag/pool	SACV12X34-66		1						
*	Hardware bag/pool	SACV12X34-74			1					
*	Hardware bag/pool	SACV12X34-86				1				
*	Hardware bag/pool	SACV12X34-98					1			
*	Hardware bag/pool	SACV12X34-113						1		
*	Hardware bag/pool	SACV12X34-129							1	
*	Hardware bag/pool	SACV12X34-147								1
**	Hardware bag/wall	1050000054	1	1	1	1	1	1	1	1
***	Hardware bag/pool	SACVHL12114-35	1							
***	Hardware bag/pool	SACVHL12114-42		1						
***	Hardware bag/pool	SACVHL12114-53			1					
***	Hardware bag/pool	SACVHL12114-63				1				
***	Hardware bag/pool	SACVHL12114-74					1	1		
***	Hardware bag/pool	SACVHL12114-84							1	
***	Hardware bag/pool	SACVHL12114-95								1
	Thrus phill 18-8 bolts 18-8 1/4-0x3/4	99-0023	31	31	31	31	31	31	31	31
	Flange nuts 1/4-20 Serrated	2FGS422	31	31	31	31	31	31	31	31
	Instruction DVD	SACWBI36876	1	1	1	1	1	1	1	1

* In the hardware bag/pool you will find parts: #V12x34

** In the hardware bag/wall you will find parts: #99-0023 - 2FGS422

*** In the hardware bag/pool you will find parts: #VHL12114S

Section
1

GENERAL INSTRUCTIONS - ROUND POOLS
GROUND PREPARATION

PARTS LISTING - EXPLODED VIEW

Magnus RTR
PZEN-54RSRSRSB11
Round

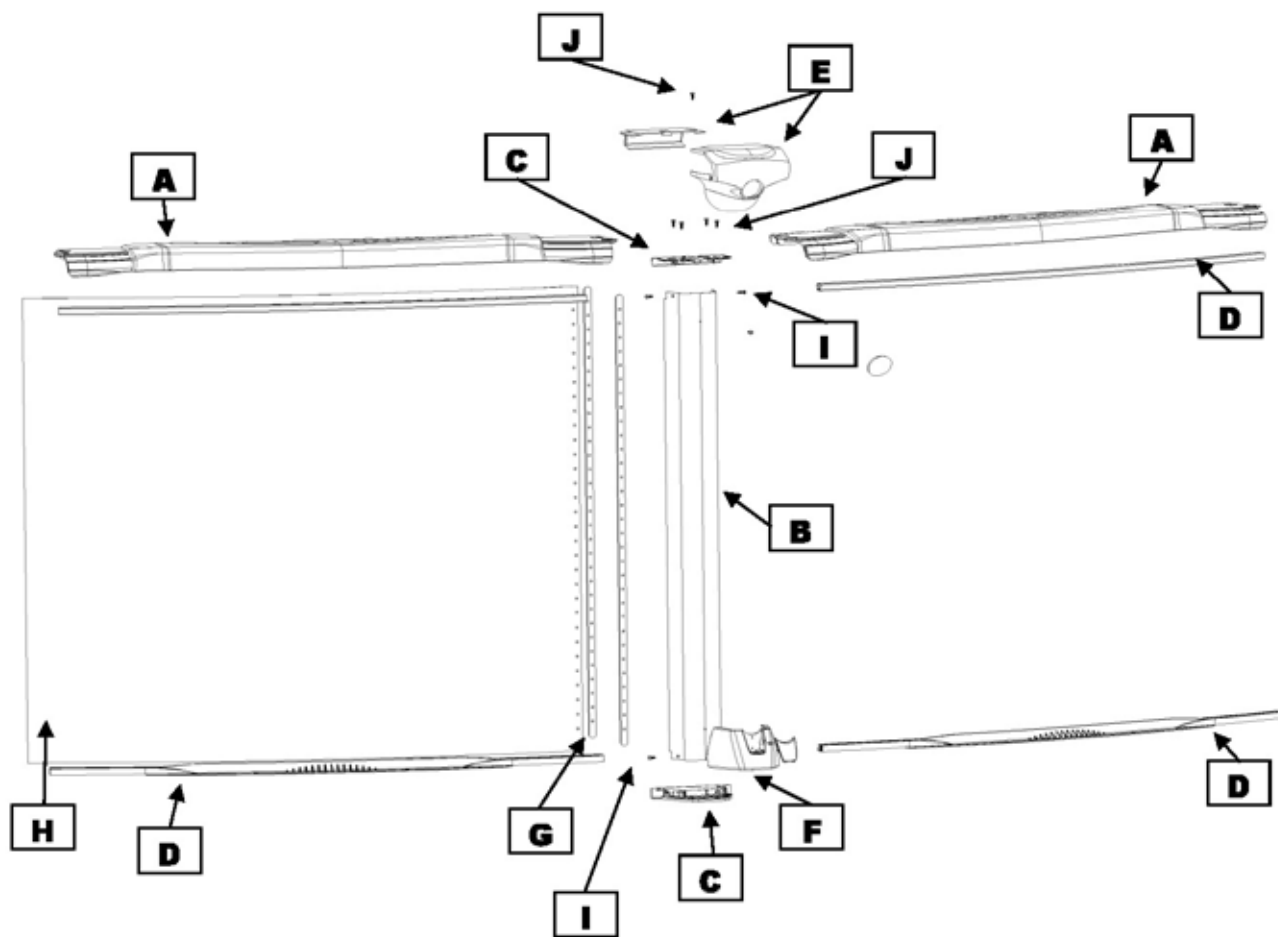

**Section
1**

**GENERAL INSTRUCTIONS - ROUND POOLS
GROUND PREPARATION**

PARTS LISTING - CONTENT

Product Description :		Magnus Round	Revised Sept 2018							
Product Code :		PZEN-54RSRSRB11								
Index#	Description	Part #	Quantity required for installation (by pool size)							
			12	15	18	21	24	27	30	33
A	Top ledge	AR744-001-R	8	10	12	14	16	18	20	22
B	Upright	ART811-R12954M	8	10	12	14	16	18	20	22
C	Top plate	21120A	8	10	12	14	16	18	20	22
C	Bottom plate	CG21120B	8	10	12	14	16	18	20	22
D	Stabilizer	LA1255612	8							
D	Stabilizer	LA1255615		10						
D	Stabilizer	LA1255618			12					
D	Stabilizer	LA1255621				14				
D	Stabilizer	LA1255624					16			
D	Stabilizer	LA1255627						18		
D	Stabilizer	LA1255630							20	22
D	Bottom rail	1525515	8	10	12					
D	Bottom rail	1525524				14	16	18		
D	Bottom rail	1525530							20	22
E	Ledge cover	AR211-23120ABC	8	10	12	14	16	18	20	22
F	Foot cover	AR711-23300AC	8	10	12	14	16	18	20	22
G	Steel bars	11825	2	2	2	2	2	2	2	2
H	Wall		1	1	1	1	1	1	1	1
I	Screw 12x3/4	V12x34	58	74	86	98	113	129	140	156
J	Screw 12x1-1/4S	VHL12X114S	35	42	53	63	70	74	84	88
*	Hardware bag/pool	SACV12X34-58	1							1
*	Hardware bag/pool	SACV12X34-66							1	
*	Hardware bag/pool	SACV12X34-74		1					1	
*	Hardware bag/pool	SACV12X34-86			1					
*	Hardware bag/pool	SACV12X34-98				1				1
*	Hardware bag/pool	SACV12X34-113					1			
*	Hardware bag/pool	SACV12X34-129						1		
**	Hardware bag/wall	1050000054	1	1	1	1	1	1	1	1
***	Hardware bag/pool	SACVHL12114-35	1				2			1
***	Hardware bag/pool	SACVHL12114-42		1						
***	Hardware bag/pool	SACVHL12114-53			1					1
***	Hardware bag/pool	SACVHL12114-63				1				
***	Hardware bag/pool	SACVHL12114-74						1		
***	Hardware bag/pool	SACVHL12114-84							1	
	Thrus phill 18-8 bolts 18-8 1/4-0x3/4	99-0023	31	31	31	31	31	31	31	31
	Flange nuts S/S 1/4-20 Serrated	2FGS422	31	31	31	31	31	31	31	31
	Instruction DVD	SACWBI36876	1	1	1	1	1	1	1	1

* In the hardware bag/pool you will find parts: #V12x34

** In the hardware bag/wall you will find parts: #99-0023 - #2FGS422

*** In the hardware bag/pool you will find parts: #VHL12114S

Section 1

GENERAL INSTRUCTIONS - ROUND POOLS GROUND PREPARATION

READ ALL INSTRUCTIONS CAREFULLY

The approximate time it takes for installation, excluding earthworks and filling is about 1/2 day. You will need at least 3 people to help with installation.

A. DETERMINE THE LOCATION OF YOUR POOL

1. The Terrain

Pay special attention to choosing the right location for your pool:

- Choose a large area, as flat and level as possible and well drained. *(Image 1)*

- Choose a spot on dry, firm earth (stabilizer or other)—do not install the pool on asphalt, tar or oil based surfaces, gravel, peat moss, wood or chemically treated soil.

- Check with your pool dealer to see if Nut Grass grows in your area. This type of grass may grow up through your pool liner. Your dealer will be able to advise how best to treat the site.

- Sloped areas will need to be made level by digging away high spots, not by filling low spots—be prepared to hire earth-moving equipment if necessary.

(Images 2a & 2b)

- Ensure the earth is well compacted and a wall is placed to prevent the earth from seeping out.

(Image 2a)

- If you need to install partly in the ground, you must contact your dealer to see if this is an option for you and that you meet law requirements in your jurisdiction. *(Image 2c)*

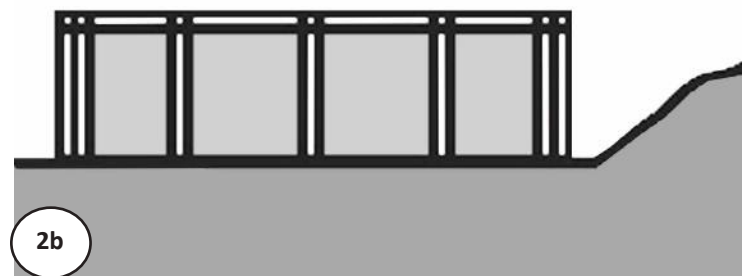
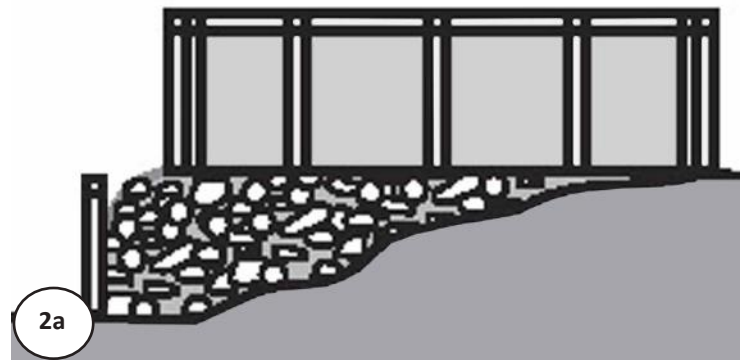
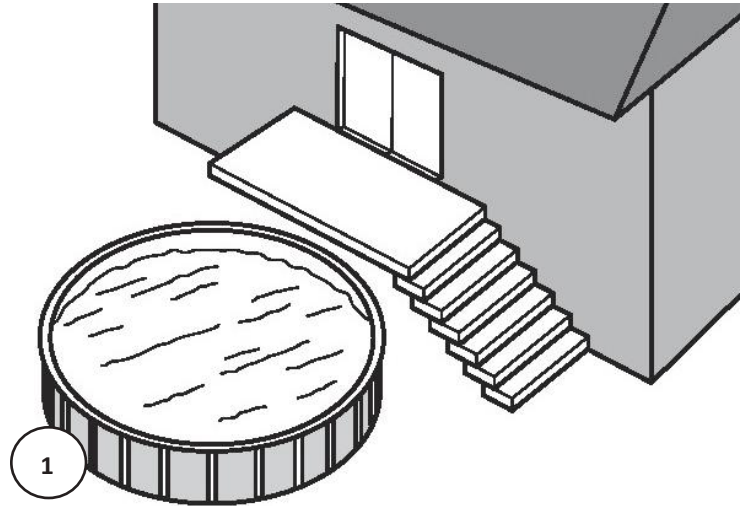

Important Note:

Ground preparation is one of the most important steps in the installation process. A proper foundation will ensure the rest of the pool assembly goes smoothly and that no problems will occur when the pool is filled with water.

Section 1

GENERAL INSTRUCTIONS - ROUND POOLS GROUND PREPARATION

A. CONT. DETERMINE THE LOCATION OF YOUR POOL

2. Things to Avoid

Do not locate your pool near or on any of the following (*Images 3a to 3c*):

- Overhanging tree branches.
- Overhead wires and clotheslines.
- Buried pipes and wires. Contact your gas, electric and telephone utilities to find buried pipes and wires before you dig.
- Areas with poor drainage.
- Grass, stones and roots. Grass will rot underneath the pool liner, and stones and roots will damage the pool liner.
- Areas recently treated with oil-based weed killers, chemicals or fertilizers.

3. Plan Ahead

- Will you be adding an adjacent deck later? Be sure to leave room.
- Will you be using pool accessories or other appliances that need electricity or gas? Locate your pool near these services or plan to have them installed later by a licensed contractor.

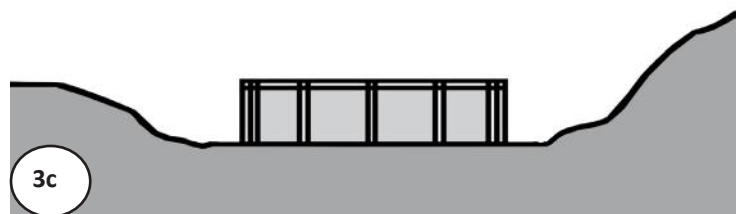
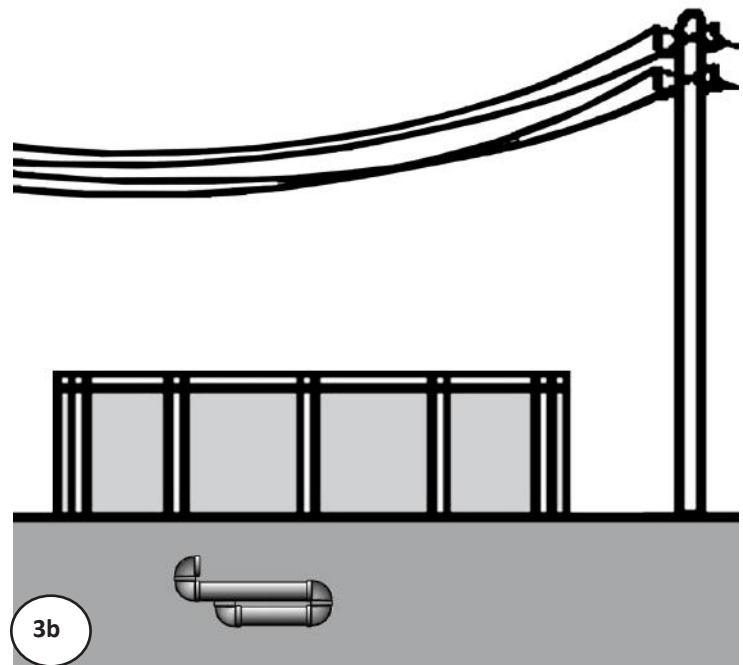
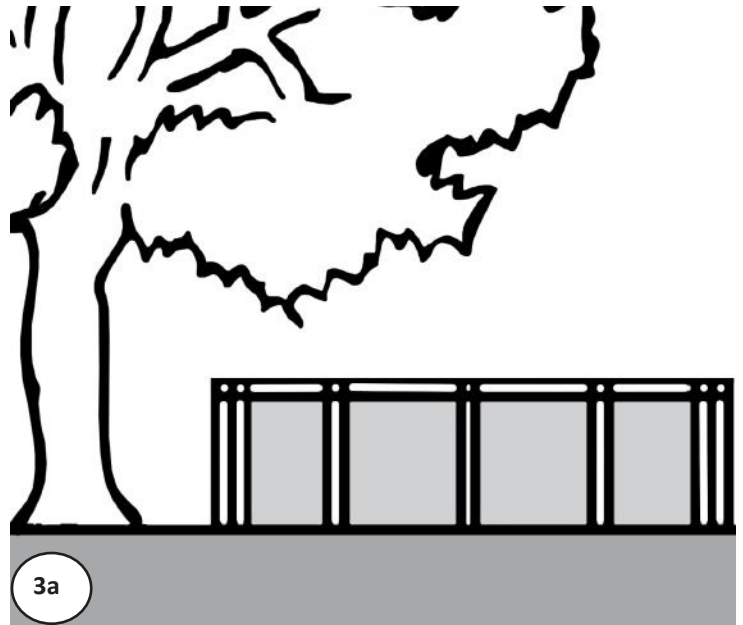

Important Note:
 When locating the centre of the pool, be sure to take into consideration any structures (deck, patio, house) or relevant items (change rooms, gazebo, etc.) that the pool may need to line up with and ensure that the pool is in the most visual pleasing location for your property.

Section 1

GENERAL INSTRUCTIONS - ROUND POOLS GROUND PREPARATION

A. CONT. DETERMINE THE LOCATION OF YOUR POOL

4. Tools Needed

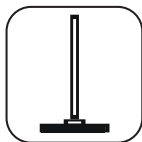

Compactor



Hammer



Water hose



Level



File



Vacuum cleaner



Pliers

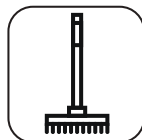

Rake



Lawn roller



Metal snips



Screwdriver



Wheelbarrow



Shovel



Spraypaint



Mallet



Measuring tape



Duct tape



Trowel



Wrench



Gloves

List of required materials

- Straight wood plank
- Material that provides a permanent base (ex. Crushed stone)
- Fine sand (void of debris)
- Cement blocks (5cm x 20cm x 40cm / 2"x 8"x16") (optional)
- 2x Plywood (60cm x 120cm / 2ft x 4ft)
- Wood board (30cm x 20cm / 1ft x 1ft)
- Vinyl covered hooks (to hold wall steady)
- String and stakes & wooden pegs
- Prefabricated cove sections (optional)
- Pool carpeting (optional)
- Rope
- Polyethylene Plastic Sheetting



- Optical Level
Can be useful for precise measurements

Section 1

GENERAL INSTRUCTIONS - ROUND POOLS GROUND PREPARATION

B. PREPARE THE FOUNDATION OF YOUR POOL

1. Mark out the Area

- Drive a peg into the ground at the centre of the area where you want your pool. *(Image 1)*
- Use a length of string tied between the peg and a can of spray paint, and mark a circle on the ground (a tape measure can also be used). The circle will be 12" (30 cm) bigger all round than the pool. *(Image 2)*

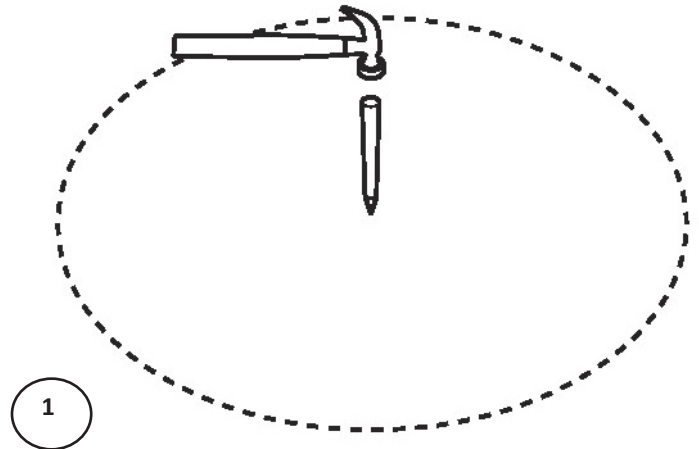

2. Remove the sod

- Remove all sod and plants from the circle. *(Image 3)*
- Remove any sticks, stones and roots from the circle using a rake.
- To make sure your pool is stable, compact the ground well, use the compactor, before adding the sand.

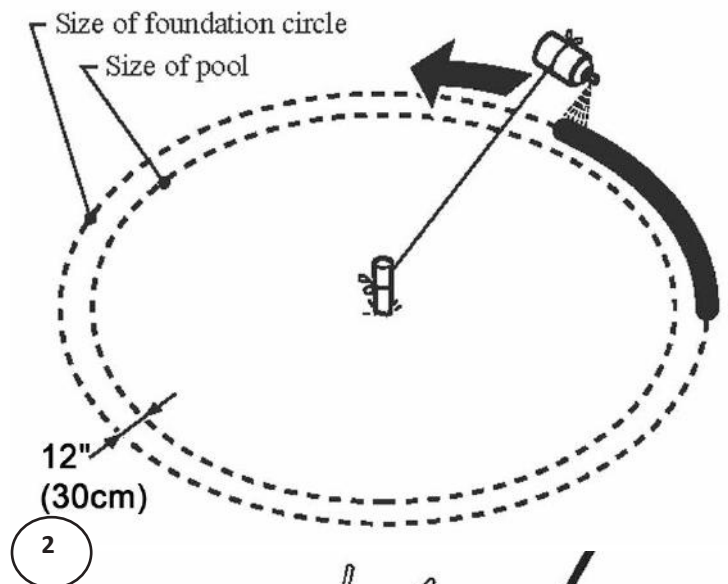

⚠ Important Note:
Your pool must be perfectly level. Take the time you need to be sure your foundation is perfectly level.

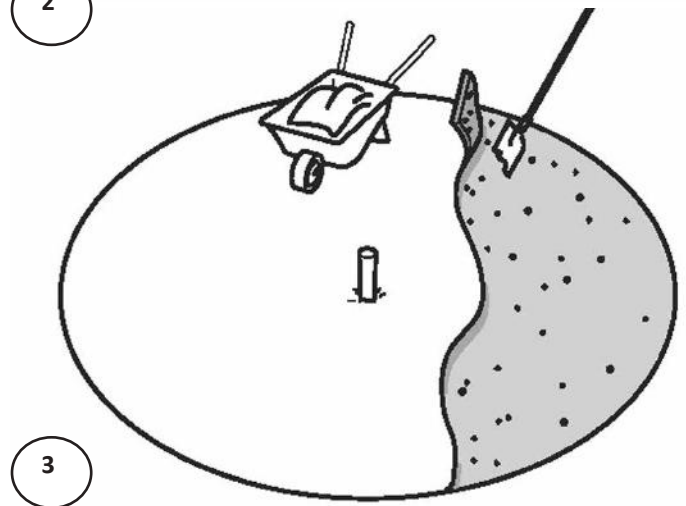

Section 1

GENERAL INSTRUCTIONS - ROUND POOLS GROUND PREPARATION

B. CONT. PREPARE THE FOUNDATION OF YOUR POOL

3. Make the are flat and level

- a. Replace the centre peg with a flat-topped stake, at least 1" (25 mm) square and 6" (15 cm) long. Drive it down flush with the ground surface.
- b. Nail one end of a straight 2-by-4 (5cm x 10cm) wood plank to the top of the stake. Use a nail long enough to hold the end of the 2-by-4 (5cm x 10cm) wood plank to the stake while you rotate it in a circle. *(Image 4)*
- c. Put a carpenter's level on the wood plank and swing the board in a circle to find the high and low spots. *(Image 5)*
- d. Remove all the high spots with a shovel, hoe or rake. *(Image 6)*

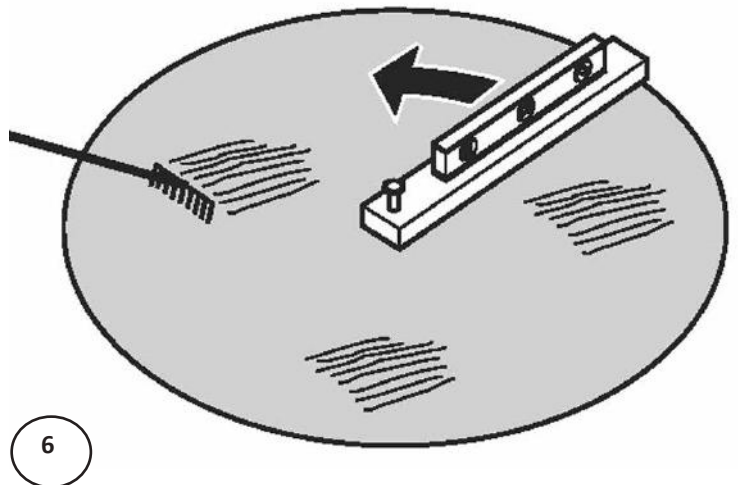
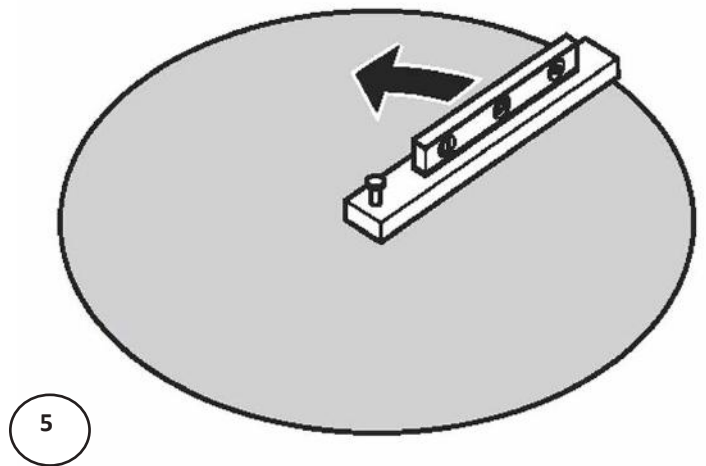
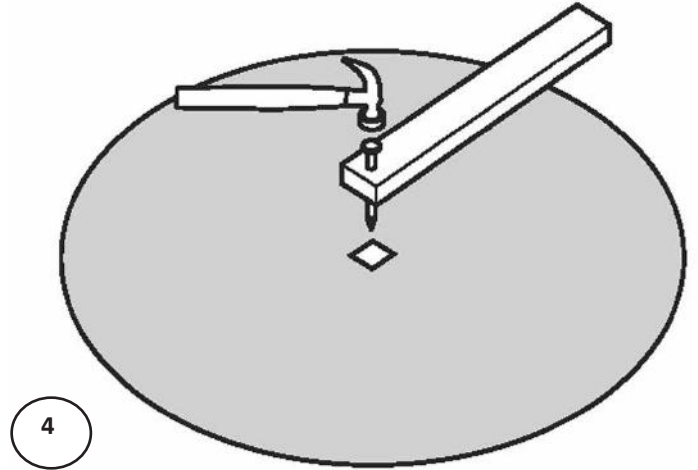

Important Note:

Use the optical level to ensure that the ground is perfectly flat and level.

Section 1

GENERAL INSTRUCTIONS - ROUND POOLS GROUND PREPARATION

B. CONT. PREPARE THE FOUNDATION OF YOUR POOL

- e. Be prepared to hire earth moving equipment if you need to level a large area. Remember, your pool must be level across the diameter of the pool. *(Image 7)*

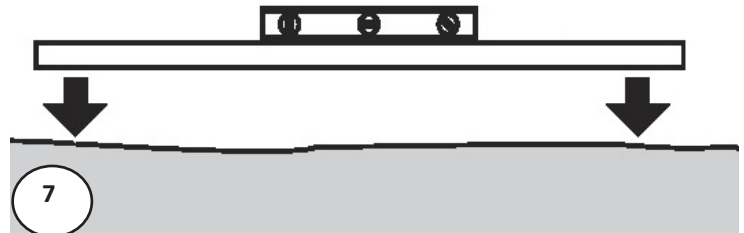

- f. Small dips and hollows may be filled in, but the soil must be hard-packed and well compacted with a **tamping tool**.

- g. Take material such as rock dust or fine mortar that can conform a solid, permanent base and deposit this material around the rim of the basin. The material used should be spread around the perimeter of the pool to a width of 24" (60cm) and a thickness of 2" (5cm). *(Image 8)*

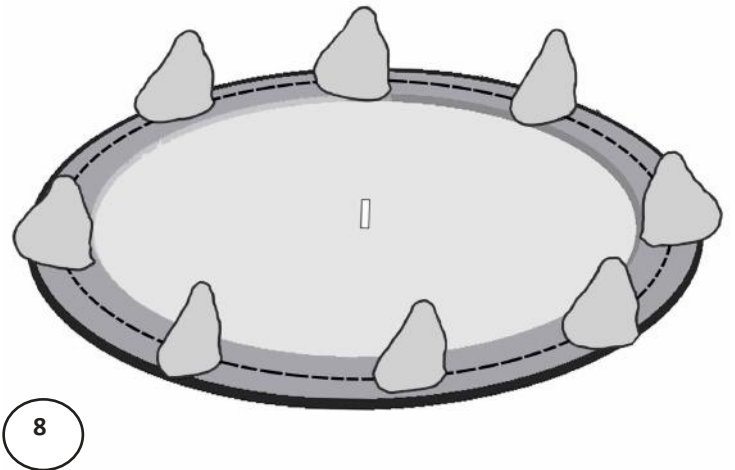

Note: Bottom rails will be placed in the center of the perimeter of the pool see the dashed line. *(Image 8)*

- h. Recheck the outer perimeter of the circle, where the pool wall will be. Compact the ground and make sure there are no high or low spots. The bottom edge of the pool wall must rest flat on the ground and have no gaps under it. *(Image 9)*

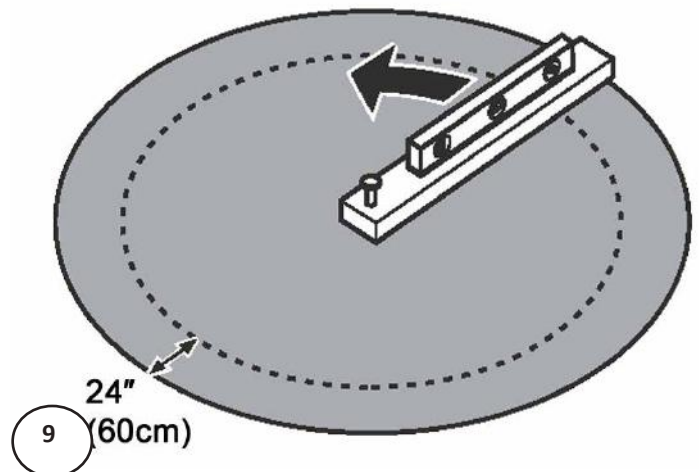

Important Note:

The outer 24" (60cm) of the circle must be perfectly flat. The bottom edge of the pool must rest flat on the ground and have no gaps under it. Take the time you need to be sure this area is perfectly flat and level.

Section 1

GENERAL INSTRUCTIONS - ROUND POOLS GROUND PREPARATION

B. CONT. PREPARE THE FOUNDATION OF YOUR POOL

- i. Go over the entire perimeter of the pool to ensure that at every 3" the surface is completely level.
- j. Lay out the bottom rails and bottom plates around the circle.
- k. Check the roundness of your circle, by measuring the diameter across in several locations. Since the bottom rails do not automatically form a true circle, **DO NOT SKIP THIS STEP!** Otherwise you might end up with a slightly oval shape, which can cause problems later on. *(Image 10)*
- l. Verify the height of each bottom plate with an optical level. They have to be at the same height. Adjust height if necessary.

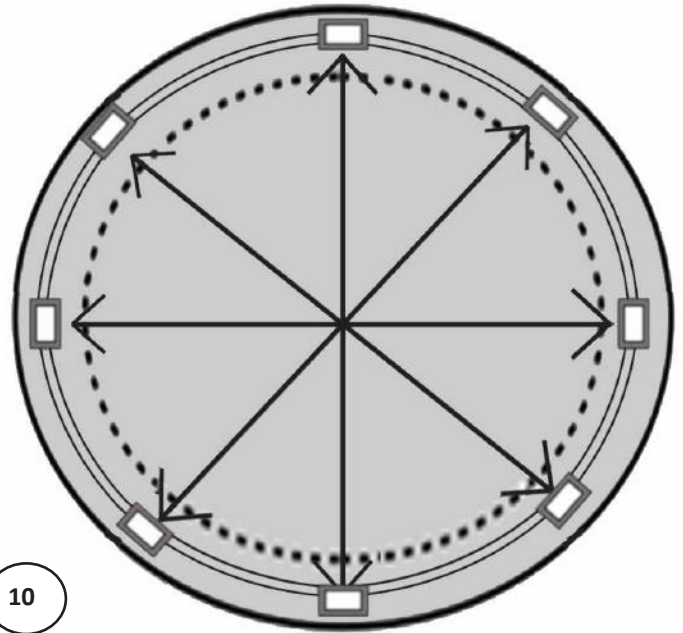

Section 1

GENERAL INSTRUCTIONS - ROUND POOLS GROUND PREPARATION

B. CONT. PREPARE THE FOUNDATION OF YOUR POOL

4. Patio Stones (Recommended)

- Concrete patio stones may be placed at the base of each upright of your pool.
- Each bottom plate will show the location for a patio stone. Make a mark in the ground at each base plate. *(Image 12)*
- Remove the bottom rails and bottom plates and lay out the patio stones around the circle where the bottom plates were. *(Image 13)*
- The patio stones **must** be sunk into the ground so the tops are flush with the soil around them. Use the carpenter's level to make sure the patio stones are perfectly level and flush with the ground. Use either the carpenter's level and a 2-by-4 (5cm x 10cm) wood plank, or the optical level between patio stones to make sure the stones are level with each other. *(Image 14)*
- Do not install blocks or rails on loose sifted soil or sand. There must be no space between the ground and the bottom of the rails. All patio blocks **must be flush with the ground**, solid and level with each other in all directions.

NOTE: Installing patio blocks is recommended. Patio blocks may shift due to temperature changes.

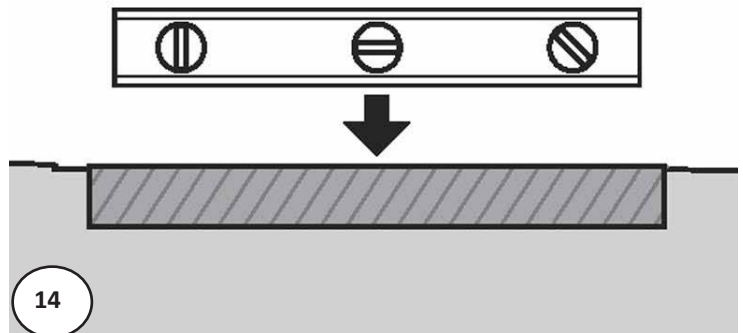
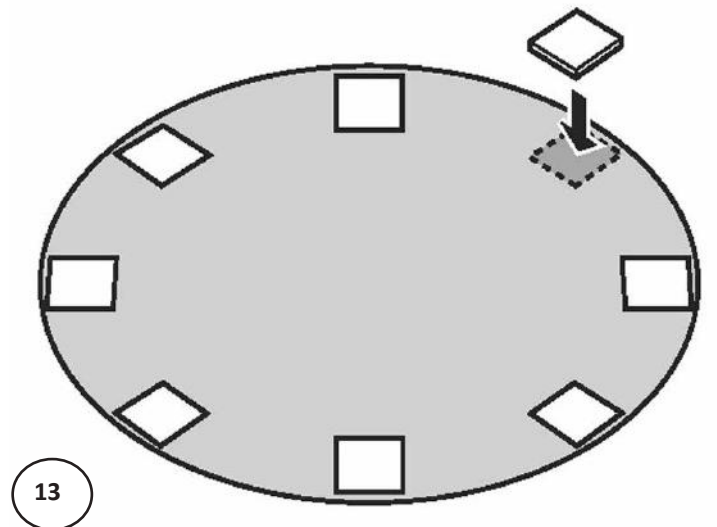
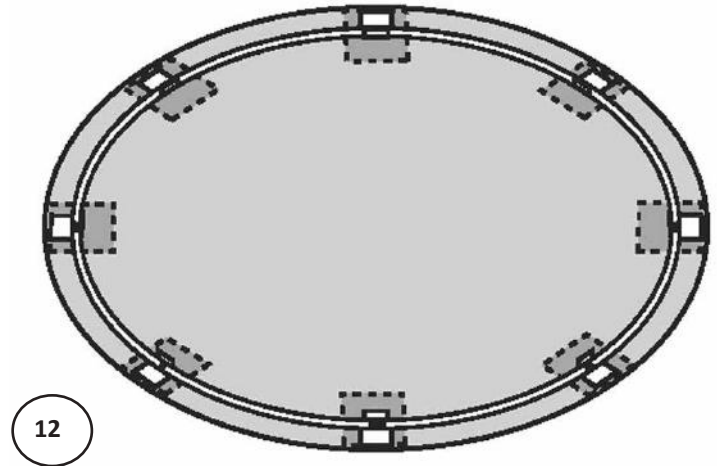

Important Note:
Make sure the patio stones are perfectly level and flush with the ground. All patio blocks must be flush with the ground, solid and level with each other in all directions.

5. Proceed to Section 2 - Assembling the Pool Base

Section 1

GENERAL INSTRUCTIONS - ROUND POOLS GROUND PREPARATION

ROUND FOOTPRINT - For - PZEN-52/54 SSPSPSB10/11/19

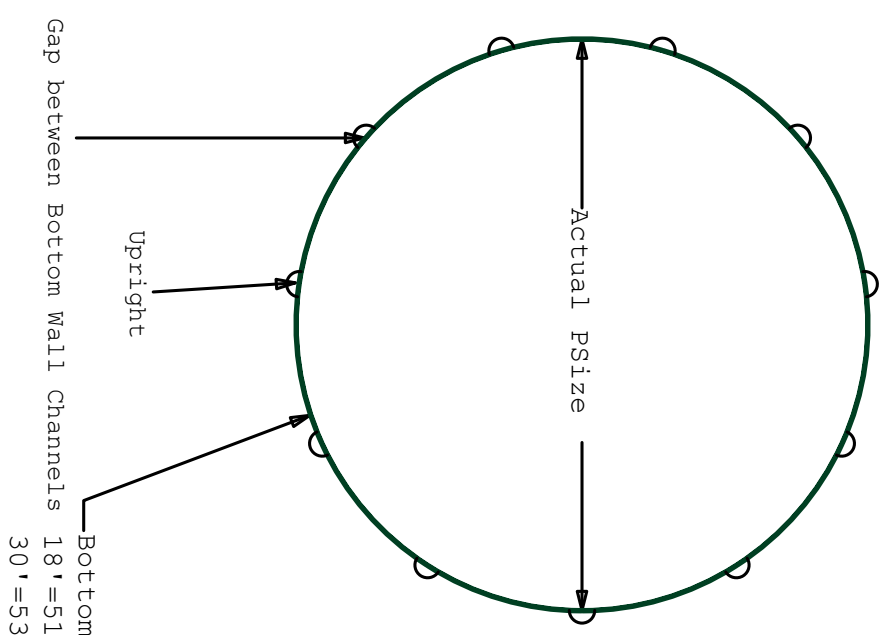

- Notes:
1. All dimensions are in inches unless otherwise specified.
 2. All dimensions are referenced from the wall location.
 3. Manufacturers tolerances and field condition may result in dimensional variations.

ZENITH ROUND STEEL POOL CHART										
Pool Name	8'	12'	15'	18'	21'	24'	27'	30'	33'	
Uprights	10	9	11	13	15	17	19	21	23	
Radius of Rails	4'	6'	7.5'	9'	10.5'	12'	13.5'	15'	15'	
Gap between Rails	3/16"	11/16"	3/8"	1/2"	9/16"	9/16"	9/16"	1/2"	3/4"	
Wall Perimeter	302	454	565	679	792	905	1018	1131	1244	
Wall Length	303	455	566	680	793	906	1019	1132	1245	

Section 1

GENERAL INSTRUCTIONS - ROUND POOLS GROUND PREPARATION

ROUND FOOTPRINT - For - PZEN-52/54RSPSPSB10

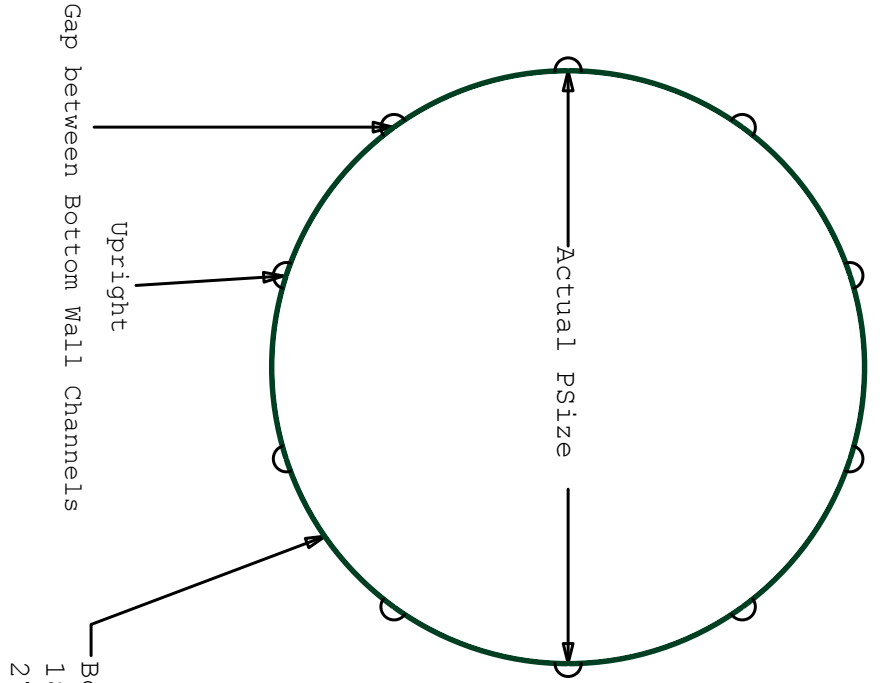

- Notes:
1. All dimensions are in inches unless otherwise specified.
 2. All dimensions are referenced from the wall location.
 3. Manufacturers tolerances and field condition may result in dimensional variations.

SIMBIO ROUND STEEL POOL CHART									
Pool Name	12'	15'	18'	21'	24'	27'	30'	33'	
Uprights	8	10	12	14	16	18	20	22	
Radius of Rails	6'	7.5'	9'	10.5'	12'	13.5'	15'	15'	
Gap between Rails	1"	5/8"	11/16"	13/16"	7/16"	7/8"	9/16"	9/16"	
Wall Perimeters	454	565	679	792	905	1018	1131	1244	
Wall Lengths	455	566	680	793	906	1019	1132	1245	

Bottom tracks length: 12'=55.75", 15'= 55.875", 18'=55.875", 21'=55.75", 24'=56.125", 27'=55.688", 30'=56"

Section 1

GENERAL INSTRUCTIONS - ROUND POOLS GROUND PREPARATION

ROUND FOOTPRINT - For - PZEN-52RSRARSB11

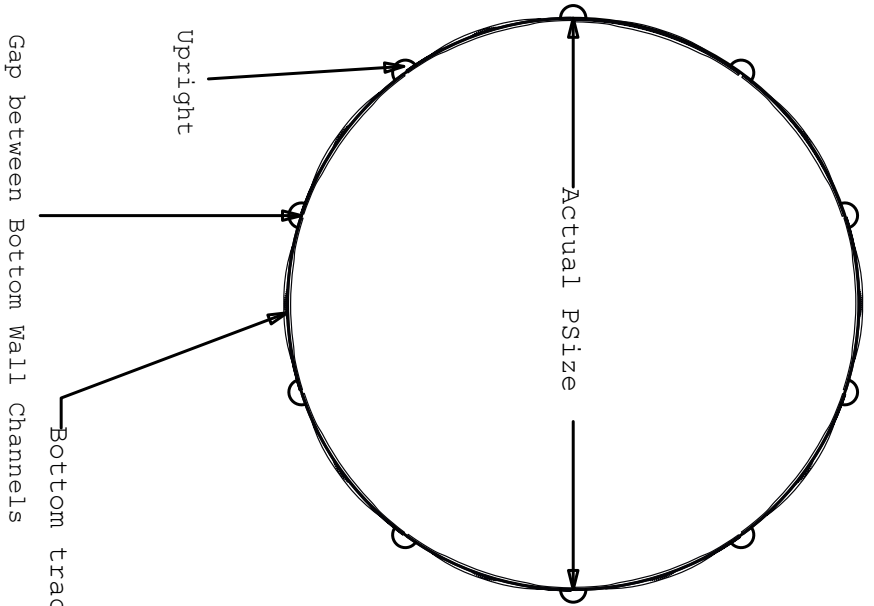

- Notes:
1. All dimensions are in inches unless otherwise specified.
 2. All dimensions are referenced from the wall location.
 3. Manufacturers tolerances and field condition may result in dimensional variations.

Bottom tracks length: 15' = 55.187", 24' = 55.312", 30' = 55.25"

ROUND RESIN POOL CHART									
Pool Name	12'	15'	18'	21'	24'	27'	30'	33'	
Uprights	8	10	12	14	16	18	20	22	
Radius of Rails	7.5'	7.5'	12'	12'	12'	12'	15'	15'	
Gap between Rails	1-9/16"	1-5/16"	1-1/4"	1-1/4"	1-1/4"	1-1/4"	1-5/16"	1-5/16"	
Wall Perimeter	454	565	679	792	905	1018	1131	1244	
Wall Length	455	566	680	793	906	1019	1132	1245	
Gap between Rails Exceptions		1-5/8"	Impact Atrium Discov						
Wall Perimeter Exceptions		568							
Wall Length Exceptions		569							

Section 2

GENERAL INSTRUCTIONS - ROUND POOLS ASSEMBLING THE POOL BASE

A. LAY OUT THE BOTTOM PLATES AND BOTTOM RAILS

1. Lay out bottom plates

- Place the bottom plates equally spaced around the perimeter of your foundation. If you are using the optional patio stones, depending on your model place one bottom plate on each stone. *(Image 1)*

2. Assemble bottom plates and bottom rails

NOTE: Depending on your pool model you may have steel or resin bottom plates.

- Insert the end of each bottom rail into a bottom plate. Leave a gap between the ends of the bottom rails.

Steel: *Image 2*

Resin: *Image 3*

See Diagram:

Please refer to your pool's footprint (Section 1) for gap measurement,

- Measure the diameter of your pool all around the circle and make sure it is correct. Note: this measurement should be taken from centre to centre of the bottom plate. When the circumference is perfectly round, hammer nails into the ground to keep the bottom rails into place.

These nails are to be removed only at the last step when filling up the pool.

Important Note:

Use a soft measuring tape to measure around the perimeter of the pool. Measure from the inside of the bottom rail, the measurement should equal the wall length.

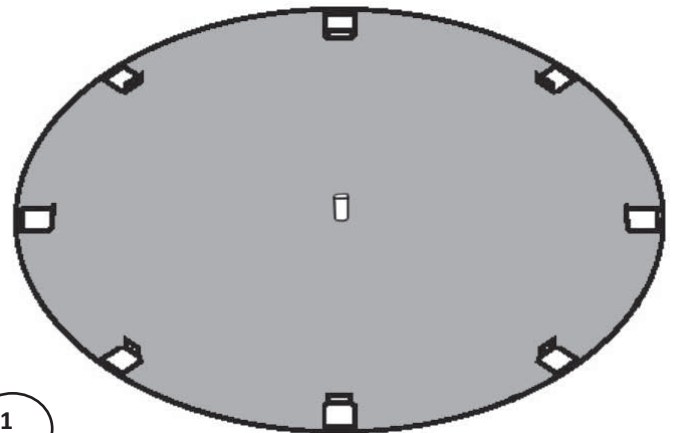

1

STEEL

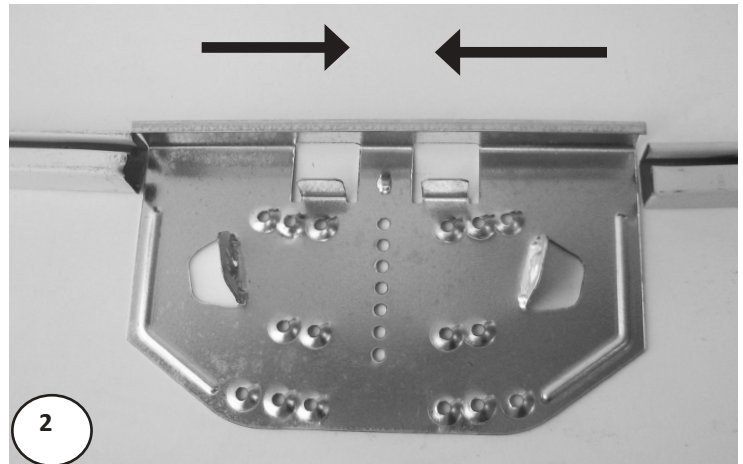

2

RESIN

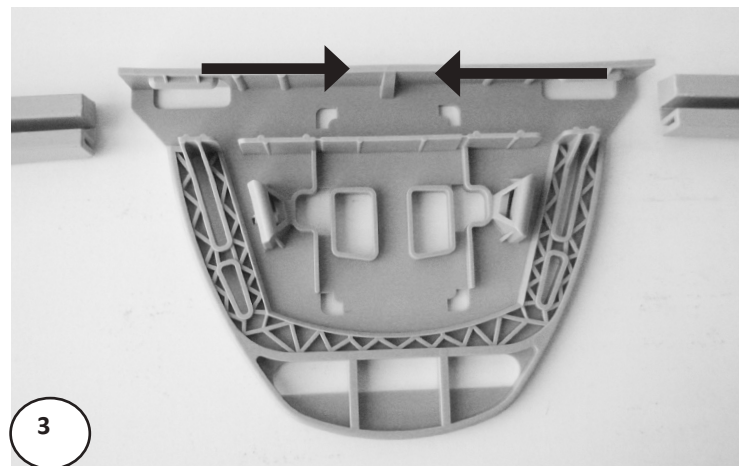

3

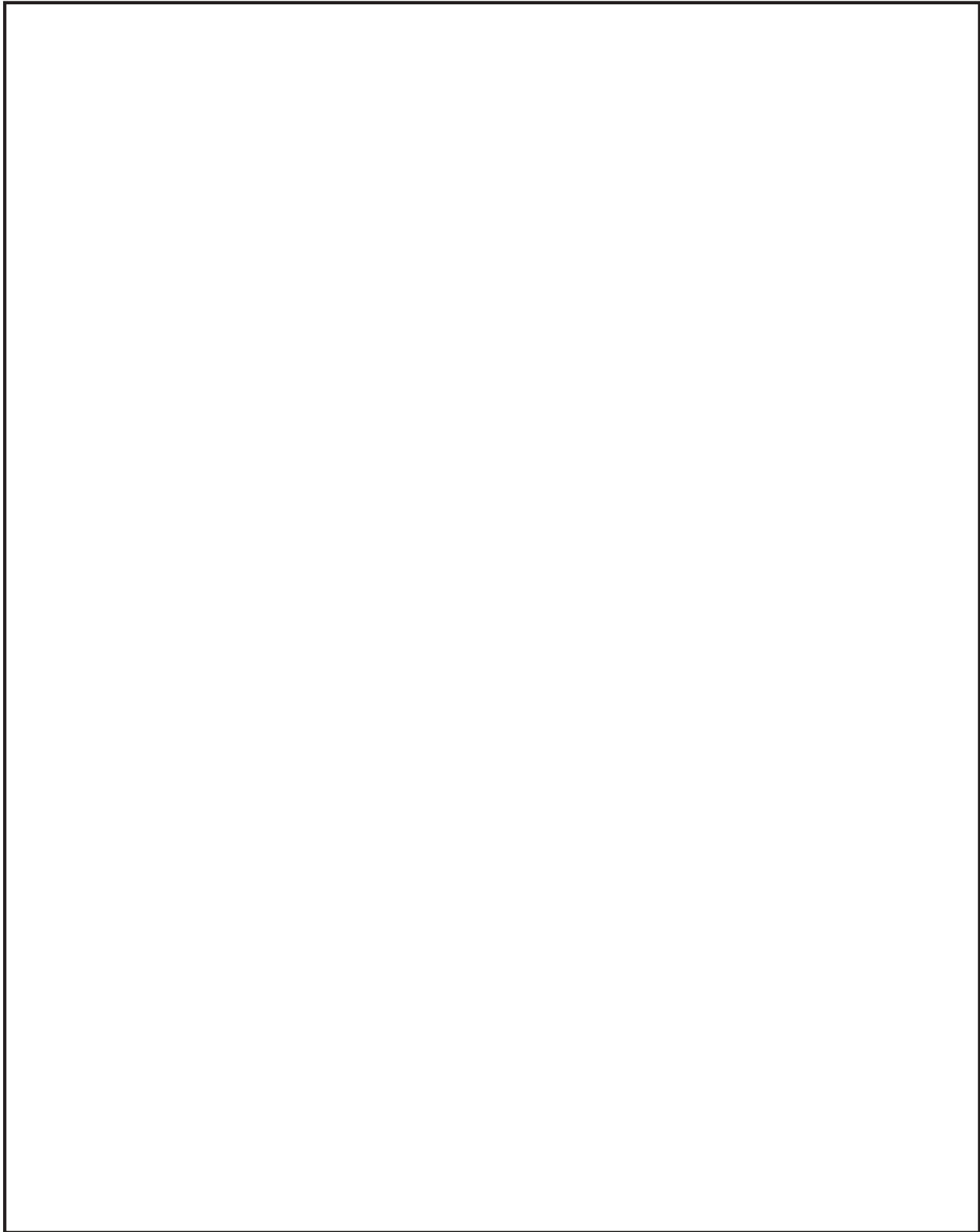

Section 3

GENERAL INSTRUCTIONS - ROUND POOLS ASSEMBLING THE POOL WALL

A. SETTING UP THE POOL WALL

Do not attempt to install the pool wall in the wind, wait for a calm day.
It takes at least 3 people to install the pool wall.

1. Preparing for the wall installation

- Bring the following items into the middle of the pool foundation before you start uncoiling the pool wall: plywood, some extra sand or fine dirt to make the cove and a ladder to climb out after the wall is assembled.
- Make sure the skimmer and water return holes are located where you need them to be. The skimmer and water return holes are positioned towards the end of the wall, **(the section before where the wall started)**.

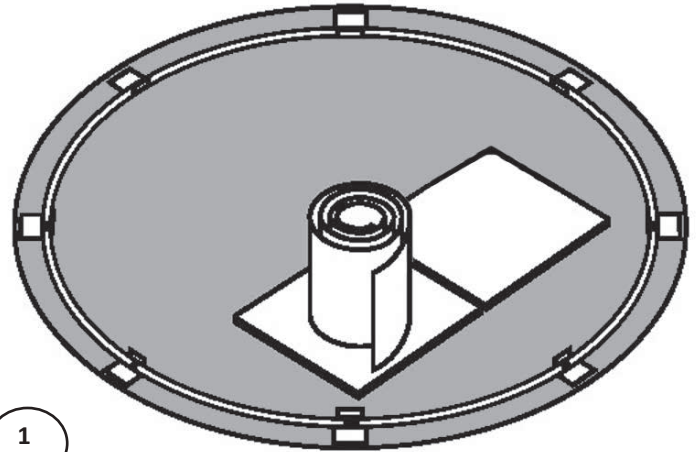

2. Set the pool wall in place

- Unpackage the coiled pool wall and stand it on the plywood at the place close to where you need to install the skimmer. **(Image 1)**
(Remember the skimmer and water return holes will be placed at the section just before where you started the wall installation).
- Start uncoiling the wall, guiding the bottom edge into the curved bottom rail. The starting end of the wall must be positioned in the centre of a bottom plate, and the skimmer and return holes should be positioned where the pump and filter will be. **(Image 2)**
- Set lengths of stabilizer onto the top edge of the wall as you uncoil it. **(Image 2)**

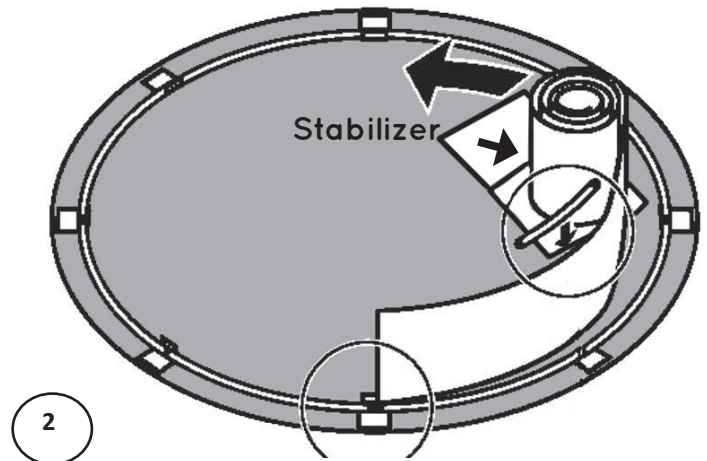

Important Note:

It is preferable to use very fine sand that is easily compacted. Be careful not to spill sand on the bottom rails.

Section 3

GENERAL INSTRUCTIONS - ROUND POOLS ASSEMBLING THE POOL WALL

A. SETTING UP THE POOL WALL

- d. We also suggest installing vinyl-covered hooks and rope to hold the wall steady. Ideally the help of several people should be solicited to hold the wall in place. Work around the foundation until the entire pool wall is uncoiled into the bottom rails. **(Image 3)**

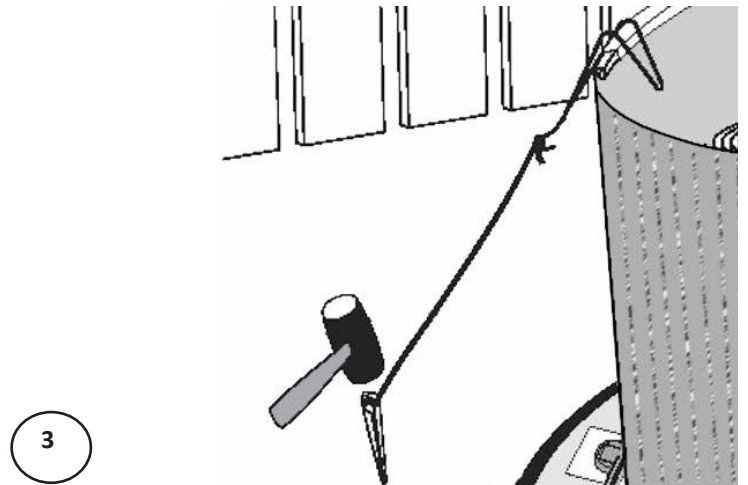

- e. When uncoiling the wall, the skimmer and return holes are positioned toward the end of the wall. **(Image 4)**

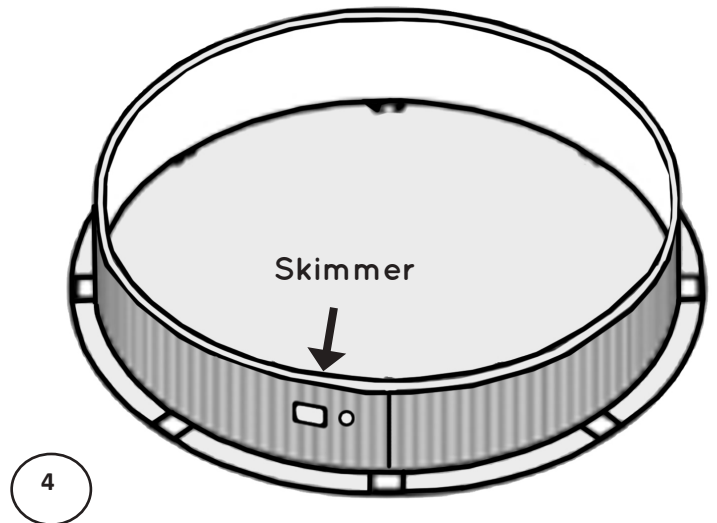

Important Note:

Do not attempt to install the pool wall in the wind. Wait for a calm day.

Section 3

GENERAL INSTRUCTIONS - ROUND POOLS ASSEMBLING THE POOL WALL

A. CONT. SETTING UP THE POOL WALL

3. Join the ends of the pool wall

a. Line up the holes in the two ends of the pool wall.
(Image 5)

b. Now that you have installed the wall you can be faced with three scenarios.

1) The wall joints align perfectly, if so, move on to the next step (c).

2) Your wall appears to be too short. **It is not.** However the space between the bottom rails must be decreased by lightly tapping the bottom plates towards the inside of the pool. You can also tap the wall lightly with both hands in the desired direction.
(Image 6)

You **MUST** recheck the gaps at each and every one of the bottom rails so that they are all equal in gap size.

3) Your wall appears too long. **It is not.** However the space between the bottom rails must be increased by tapping the bottom plates lightly towards the outside of the pool or by tapping the wall with both hands in the desired direction.
(Image 7)

You **MUST** recheck the gaps at each and every one of the bottom rails so that they are all equal in gap size.

⚠ Important Note:
Bottom rails must always be held in place in the bottom plate.

⚠ Important Note:
You **MUST** recheck the gaps at each and every one of the bottom rails so that they are all equal in gap size.

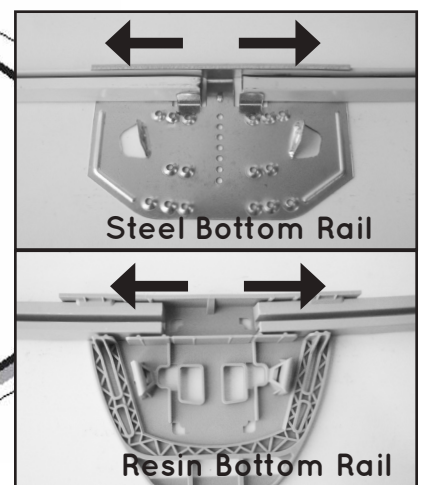
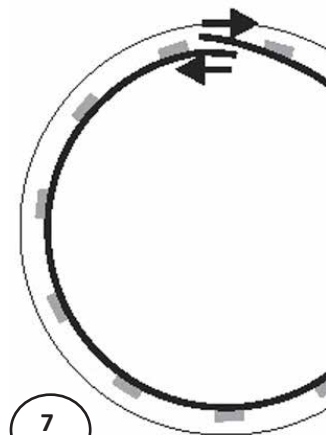
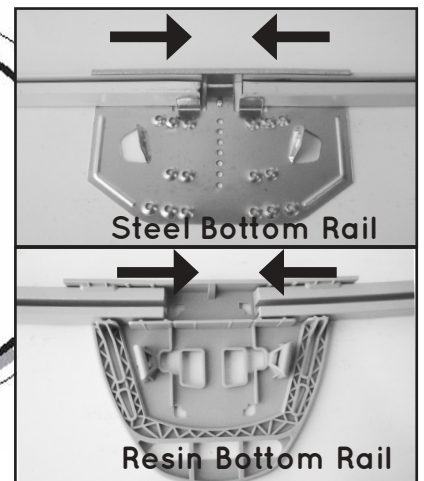
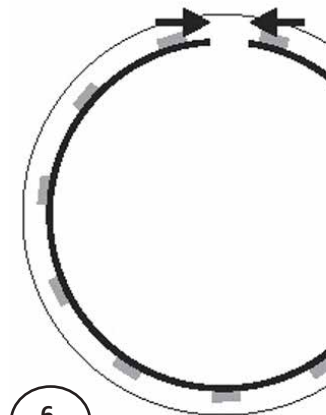
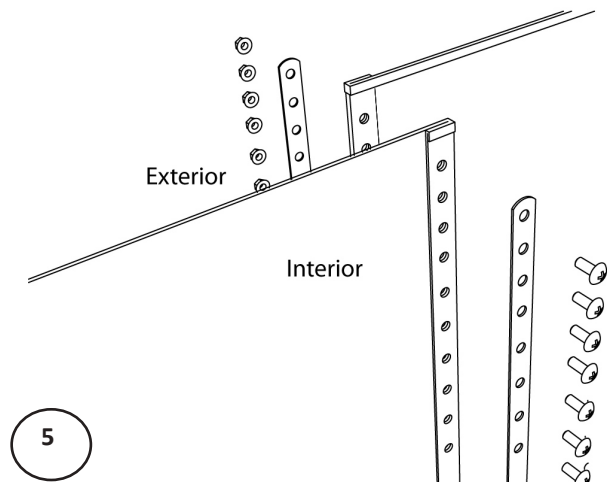

Section 3

GENERAL INSTRUCTIONS - ROUND POOLS ASSEMBLING THE POOL WALL

A. CONT. SETTING UP THE POOL WALL

- c. To fasten the wall joint, overlap the two steel bars, one on the inside and the other on the outside. Tighten the mechanical screws on the inside and the nuts on the outside. Ensure that all bolts and all the holes are used. *(Image 8)*

⚠ Important Note:
Stick a screwdriver through two of the holes to help line up the ends of the wall.

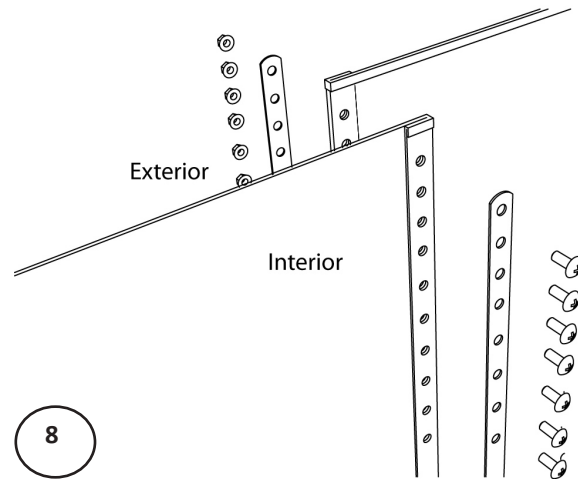

When tightening the screws start from either the top and go down or vice versa. Do not start a few screws from top and a few from the bottom to meet in the middle, this can cause problems later on.

- d. Adjusting the pool to the proper shape may cause the bottom rails and bottom plates to slip out of alignment a little. Recheck all of the bottom plates to make sure each one is centred where the bottom rails meet.
- e. Cover the seam and bolt heads on the inside/interior of the pool wall completely with 2" (50mm) duct tape. *(Image 9)*

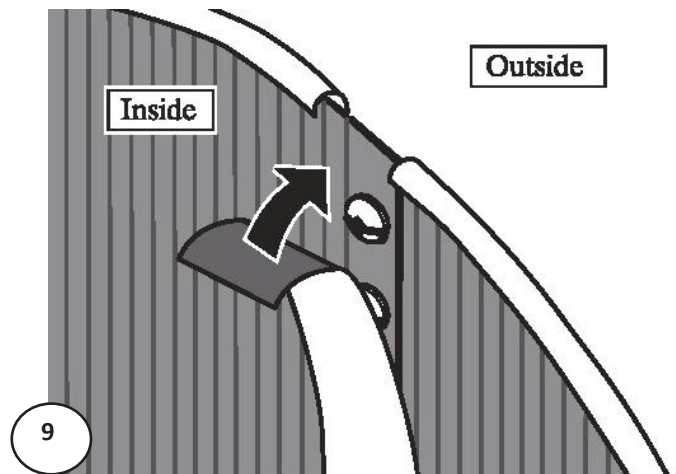

4. Make sure the pool wall is round

- a. Using a tape measure, measure across the circle at each bottom plate. The pool wall must be round. Adjust the circle by nudging the base plates in or out with your foot. *(Image 10)*

⚠ Important Note:
The pool must be level across the perimeter. A pool that is not level is dangerous and may collapse.

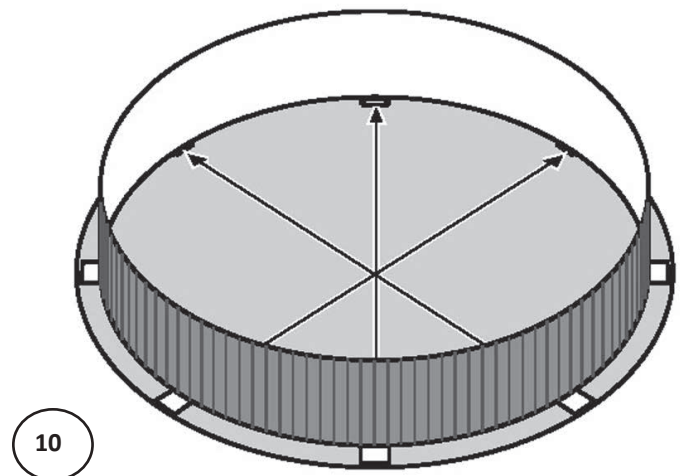

Section 3

GENERAL INSTRUCTIONS - ROUND POOLS ASSEMBLING THE POOL WALL

B. ASSEMBLING THE COVE

1. Make the cove

- a. If you are using sand, bank the sand against the wall to form a cove of 3" to 6" (7.5cm to 15cm) high and 8" to 12" (20cm to 30cm) wide at ground level. This will prevent the liner from creeping under the wall, and it will also protect the liner from any metal edges of the pool framework. **THIS STEP IS NOT OPTIONAL, IT MUST BE DONE.** (Image 11)

NOTE: If a smaller cove (less than 3" (7.5cm)) is made along with using a very tight liner, this will buckle the wall.

- b. Water the sand to compact it and use a trowel to spread it evenly. (Image 12)
- c. Since earth containing chemicals can cause discoloration or corrosion, it is suggested that you place **polyethylene plastic sheeting** under the cove around the perimeter of the wall, so no earth comes in contact with the metal. Since the presence of such chemicals is beyond the control of the manufacturer, such damage is not covered under warranty. (Image 13)
- d. If you are using styrofoam cove pieces instead of sand, insert them in the bottom rail and refer to the installation instructions that are provided with them.
- e. Proceed to your liner instructions and after liner installation proceed to Section 4-Installing the pool frame.

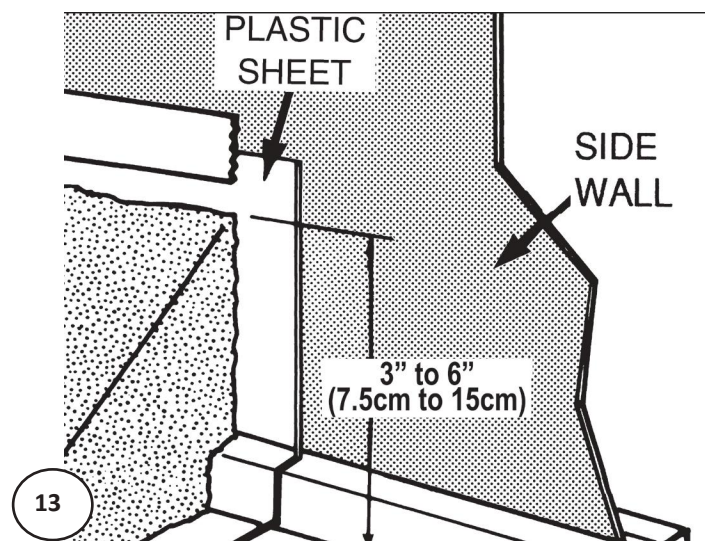
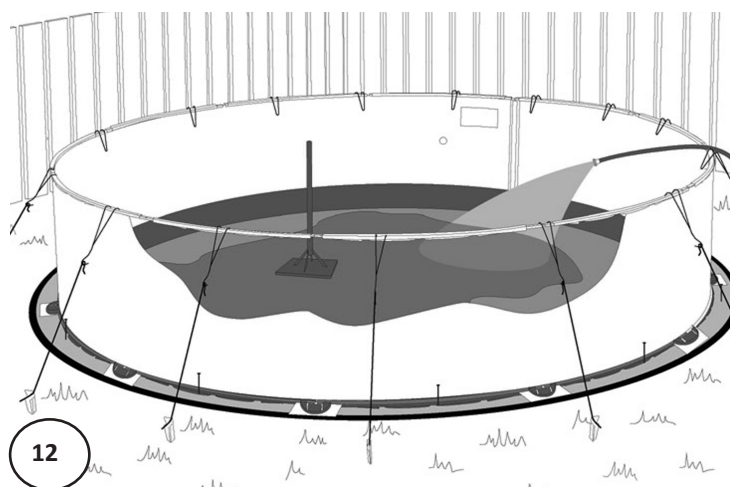
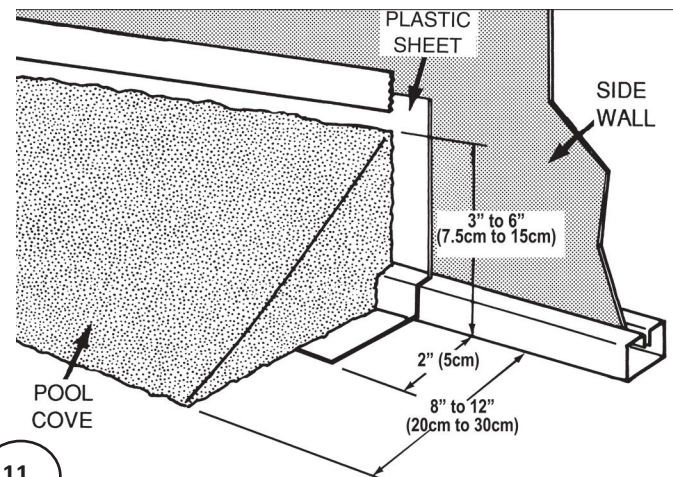

Important Note:

The cove is an important part of the pool structure. Take your time to make a complete, full-size cove.



IMPORTANT INFORMATION ABOUT YOUR LINER

We do not make or supply liners for our pools.

Please contact your liner's manufacturer with questions or if instructions are not included with the liner.

Liner must be installed per the liner manufacturer's instructions.

Incorrect liner installation may void the warranty.

Section 4

GENERAL INSTRUCTIONS - ROUND POOLS ASSEMBLING THE POOL FRAME

A. INSTALLATION OF THE UPRIGHTS

1. Install the uprights

NOTE: Depending on your pool model you may have steel or resin bottom plates.

- The wall joint is hidden behind the upright on most pools. This assures that the skimmer and skimmer return holes are not obstructed.
- Insert an upright into the bottom plate. Squeeze each side of the upright at the bottom into the bottom plate. Push firmly on the upright while ensuring that it is completely inserted into the bottom plate.
Steel: Image 1
Resin: Image 2
- Attach the bottom of the uprights to the bottom plates using a screw (V12x34). (**Image 2**)
Steel: Image 3
Resin: Image 4

⚠ Important Note:
Use the ridges in the pool wall to make sure the upright column is straight up and down.

⚠ Important Note:
Ensure to leave a gap between the two bottom rails.

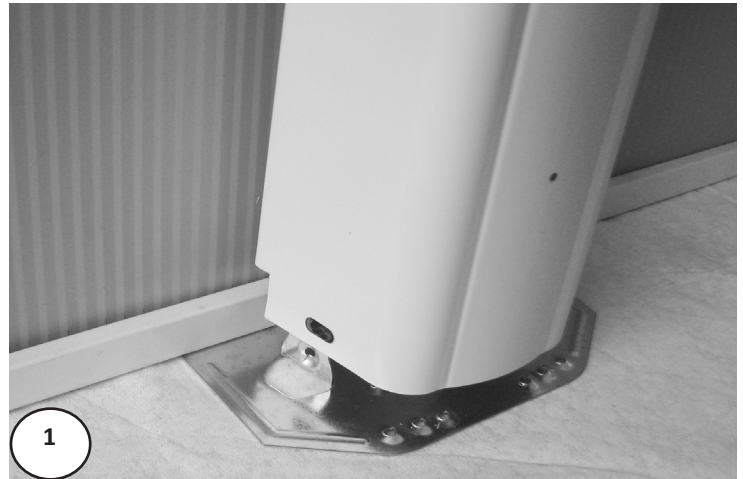

See Diagram:
Please refer to your pool's footprint (Section 1) for gap measurement.

Section 4

GENERAL INSTRUCTIONS - ROUND POOLS ASSEMBLING THE POOL FRAME

A. INSTALLATION OF THE UPRIGHTS

2. Install the footcovers

- a. If your model contains the optional footcover, attach with screw (V12x34). (*Image 5*)
- b. Install the finishing plug. (*Image 6*)

Proceed with the installation of the uprights.



 **Important Note:**
Use the ridges in the pool wall to make sure the upright column is straight up and down.

 **Important Note:**
Ensure to leave a gap between the two bottom rails.

See Diagram:
Please refer to your pool's footprint (Section 1, last page) for gap measurement.

Section 4

GENERAL INSTRUCTIONS - ROUND POOLS ASSEMBLING THE POOL FRAME

B. INSTALLATION OF THE STABILIZERS AND TOP PLATES

1. Install stabilizers and top plates

NOTE: Depending on your pool model you may have steel or resin top plates.

- a. Install the stabilizer on the wall while ensuring to leave a gap between each end. Insert the stabilizer into either side of the top plate.

Steel: *Image 7*

Resin: *Image 9*

- b. Position stabilizers and top plates just assembled on top of wall by slightly tapping them with a mallet. Make sure the recessed portion of the top plates lie to the inside of the uprights.

- c. Ensure that the upright is level.

- d. Attach the upright to the top plate using screws (V12x34).

Steel: *Image 8*

Resin: *Image 10*

Repeat until you have installed all the stabilizers and top plates.



Important Note:

Ensure to leave a gap between the two stabilizers.



Section 4

GENERAL INSTRUCTIONS - ROUND POOLS ASSEMBLING THE POOL FRAME

C. INSTALLATION OF TOP LEDGE AND LEDGE COVERS

1. Install top ledge

NOTE: Depending on your pool model you may have steel or resin top ledge.

- a. Place top ledges on the wall. Align the holes on the top ledges with those on the top plates. Make sure the space left between each top ledge is uniform all around and that the space in question can be covered by a ledge cover. Attach the top ledges to the top plates using screws.

Steel Top Ledge on Steel Top Plate: *Image 11 (V12x34)*

Resin Top Ledge on Steel Top Plate:

Image 12 (VHL12x114S)

Resin Top Ledge on Resin Top Plate:

Image 13 (VHL12x114S)



Important Note:

We suggest that you install all the top ledges on the wall before attaching them.

Section 4

GENERAL INSTRUCTIONS - ROUND POOLS ASSEMBLING THE POOL FRAME

C. INSTALLATION OF TOP LEDGE AND LEDGE COVERS

2. Install ledge covers

NOTE: Depending on your pool model you may have steel or resin top ledge.

- a. Place interior ledge cover onto the top plate and attach with a self-tapping screw.

Steel Top Ledge on Steel Top Plate: *Image 14 (V12x34)*

Resin Top Ledge on Steel Top Plate:
Image 15 (VHL12x114S)

Resin Top Ledge on Resin Top Plate:
Image 16 (VHL12x114S)

- b. Slide the exterior ledge cover into the interior ledge cover guide. **(Image 17)**
Note: The plug is often located inside the ledge cover. Make sure you remove it before installing the ledge cover.

Note: During assembly, the inner and outer components of the ledge cover may have been slipped into each other for packaging purposes.



Important Note:

We suggest that you install all the top ledges on the wall before attaching them.

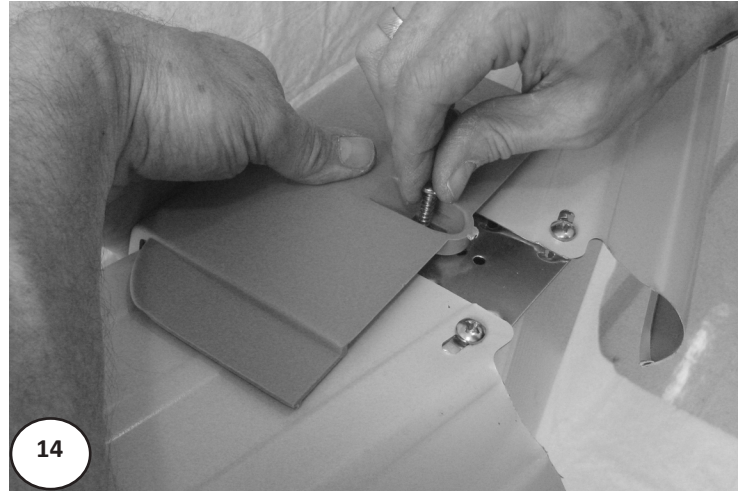

Section 4

GENERAL INSTRUCTIONS - ROUND POOLS ASSEMBLING THE POOL FRAME

C. INSTALLATION OF TOP LEDGE AND LEDGE COVERS

- c. Attach the exterior ledge cover to the upright using a screw (V12x34). **(Image 18)**
- d. Install the finishing plug on the ledge cover. **(Image 19)**



Section 4

GENERAL INSTRUCTIONS - ROUND POOLS ASSEMBLING THE POOL FRAME

D. FILL YOUR POOL WITH WATER

1. Finish filling the pool

- a. Fill the pool with water to 2" (5cm) below the lowest opening. Make sure you remove any creases from the liner in the bottom of the pool before the water level gets too high.
- b. While the pool is filling, remove the nails that were holding the bottom rails in place.
- c. Your pool is now installed. You must now install the filter and pump, the skimmer and water return inlet. Please follow the installation instructions that come with these products.

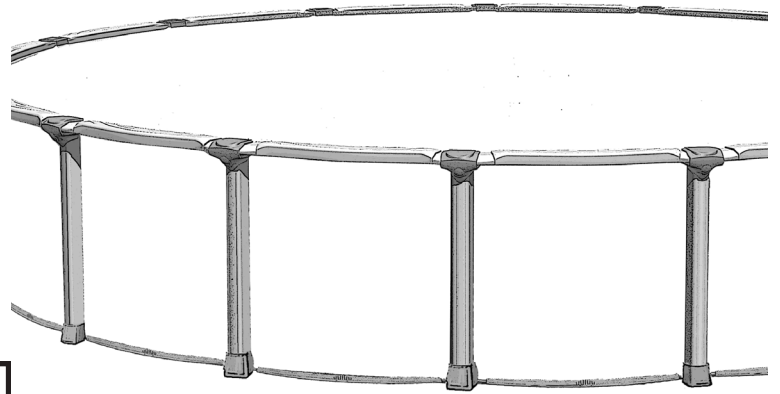
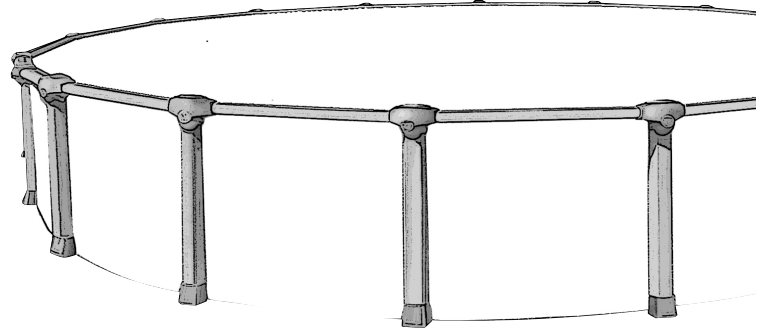

Important Note:

Before making any openings in the liner, fill the pool with 60cm (24") of water to stretch the liner fully. When filling your pool, begin with a garden hose until there is about 30cm (12") of water in the pool. This will allow the liner to stretch gradually. You can then use a heavier flow to finish filling it up.

IMPORTANT:

Make sure that your pool is round, do not assume that by filling up the pool that this will help the pool to place itself into a perfect round circle. Ensure that it is round before filling up the pool with water.

IMPORTANT SAFETY INFORMATION:

Please refer to the safety page at the beginning of this instruction manual. You must follow the rules and information regarding placement of safety stickers on your pool.

Section
4

GENERAL INSTRUCTIONS - ROUND POOLS
ASSEMBLING THE POOL FRAME

E. BASIC FLOW OF SYSTEM

1. How the system flow should look like

- a. When assembled your pool should have a basic flow system as in this image, **PLEASE CONTACT YOUR DEALER** for more specific instructions.

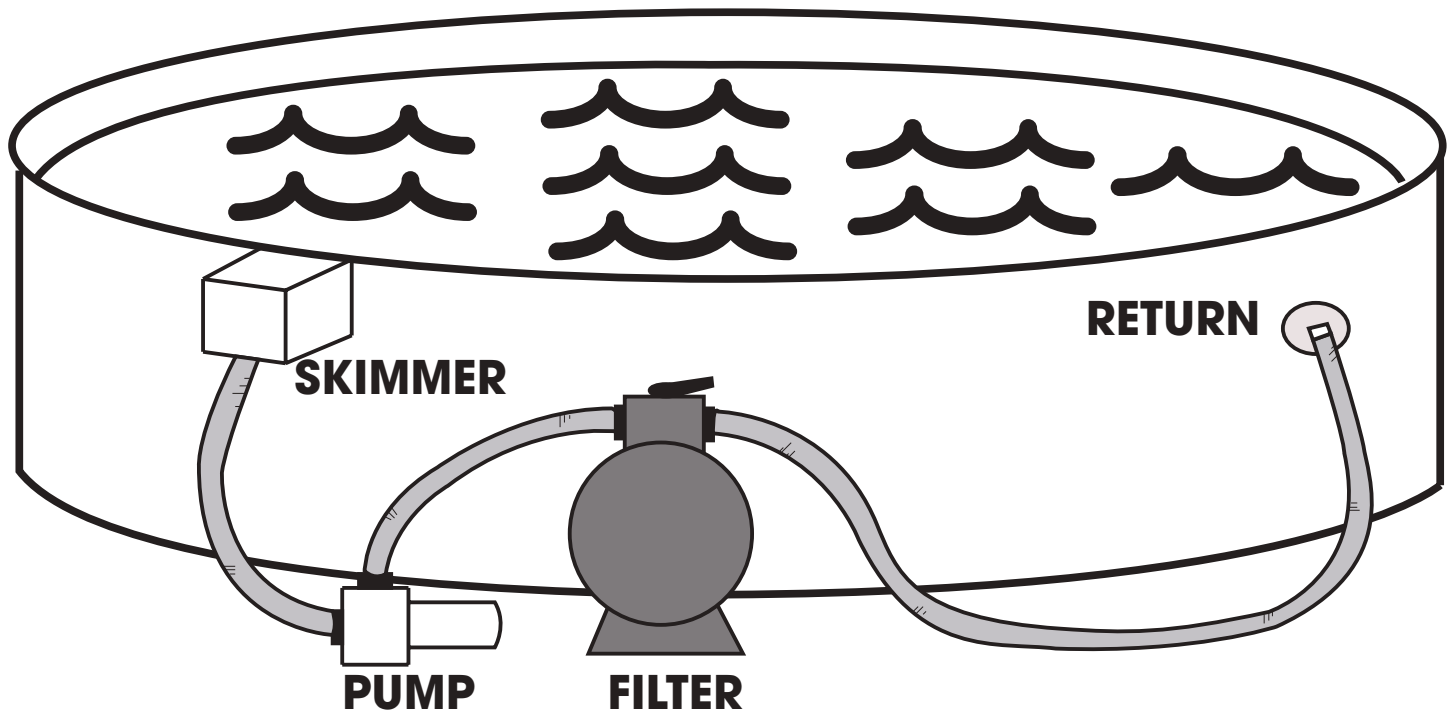

Section
5

POOL MAINTENANCE MAINTAINING YOUR POOL

POOL MAINTENANCE

Keep your pool wall and frame clean. Always wash away any deposits of pool chemicals which land on the frame of your pool. Wash periodically with a mild soap solution (no abrasives). At least once a year use a clear non-yellowing household wax on all metal components.

Your pool and liner must be inspected regularly for leaks, corrosion, scratches, and punctures. If any problem is found **IMMEDIATE CORRECTIVE ACTION MUST BE TAKEN**. Small repairs and punctures in your liner may be easily repaired using repair kits available at your local dealer. Scratches on your pool wall & frame must be touched up with anti-rust enamel. Wire brush all rust and add a coat of enamel primer followed by a coat of color matching paint. Pool water is full of various caustic chemicals, which will corrode metal parts. If any corrosion is allowed to continue, failure of the pool structure may occur which could result in excessive property damage as well as bodily harm.

The skimmer & return area and below it are particular areas that must be carefully and regularly inspected. If this area is wet, and remains wet for any length of time, it usually means there is a small leak. Skimmer/skimmer return gaskets must be replaced when they become defective. Water must not be permitted to continually run down the wall, if neglected pool will break. If proper skimmer/skimmer return gasket care is not maintained, your warranty will be void!



Important Note:

Be sure to follow all local and state safety regulations when installing any accessory to your pool. Any decks, and all entries, must be carefully monitored for safety and access to pool. Installing any other manufacturer's deck or slide is strictly forbidden!

POOL MAINTENANCE WINTERIZING YOUR POOL

WINTERIZING YOUR POOL

Along with the cool nights of autumn comes the end of the swimming season. During the winter your pool is subject to more stress than in the summer, and any breakage that is caused by incorrect winter procedures is not subject to any warranty with this company.

All of our pools are designed to be left up all winter, but nonetheless are subject to the warranty that was purchased. Continue to chlorinate and filter until the pool is closed down. If you follow our recommendations, you will be able to winterize your pool properly in a few hours.

Properly winterizing your pool will protect it from damage and make it easier for you to reopen it when spring arrives.

The key to fast and easy winterization lies in regular treatment of the water until the start of the cold season, even if you haven't been using the pool.

Routine maintenance becomes easier and less frequent as the water gets cooler. In order to keep the water clean and clear and to prevent the liner from staining, we recommend closing your pool as late as possible, i.e. toward the end of September when the water temperature is about 10°C (50°F).

Waiting until you have finished closing the pool before shutting off the filtration system will prevent hoses still connected from freezing.

Follow the instructions on the following pages or contact your retailer for further information to ensure that you are protecting your pool properly.



Section 5

POOL MAINTENANCE WINTERIZING YOUR POOL

CLOSING YOUR ABOVE GROUND POOL FOR THE WINTER

At the end of the season, you must follow these directions to make your pool ready for the winter. For areas where water freezes make sure to follow these instructions before the water is frozen, otherwise do not touch the frozen water, this may damage the pool.

STEP 1) PRIOR TO CLOSING

- a. Several days prior to closing your pool, test the water for the ph level, total alkalinity, and chloring. The water balance is important to protect the pool from corrosion or scale build-up during winter shut down.

STEP 2) PERFORM A COMPLETE INSPECTION

FINDING LEAKS

- a. Towards the end of the summer season or around mid-August, check for leaks by verifying if the pool's water level is stable. Draw a line on the liner marking the water level and wait 10 days. If after 10 days the level has dropped, then there is a leak. It is important to seal off any leaks you find. Leaks left unsealed when freezing begins can seriously damage your pool and even cause it to collapse.
- b. Vacuum carefully to remove all leaves and debris.

CHECK THE LINER

- a. Make sure the top of the liner is still attached to the pool wall. make sure there are no leaks. Repair any liner holes with a vinyl patch: any small punctures in the liner can be easily repaired with underwater repair kits available at your local retailer. Do not remove the liner from the pool, as removal of the liner will void the existing warranty.

CHECK ALL JOINTS AND SCREWS

- a. Make sure all the fram joints are fitting together properly and make sure the pool wall has not shifted from the bottom rail. Ensure all screws and bolts are tight.

CHECK FOR RUST

- a. Periodically inspect the metal parts for any corrosion especially around the skimmer area. If corrosion is found, immediate corrective action must be taken. Wire brush any rust and add a coat of enamel primer followed by a coat of color matching anti-rust enamel paint. Pool structure failure could result in major property damage and bodily harm. Paint any scratches with anti-rust paint.

Section 5

POOL MAINTENANCE WINTERIZING YOUR POOL

CLOSING YOUR ABOVE GROUND POOL FOR THE WINTER CONTINUED

STEP 3) ADD CLOSING CHEMICALS

- a. To maintain water quality, use a winter kit which contains an algicide and chlorine especially designed for this purpose. When it's time for spring cleaning, this will save you hours of work and reduce the cost of chemicals needed to restore your water quality.
- b. If your pool has a bottom drain, you will have to use pool antifreeze to prevent it from freezing during the winter. Unscrew the hose from the base of the skimmer and attach an extension. Pass the extension over the wall of the pool, making sure it remains well attached. Pour antifreeze into the extension. Leave the valve open so that water can drain from the skimmer.

STEP 4) LOWER THE WATER LEVEL

- a. Lower the water level so as to leave between 6 to 20 inches (15cm to 50cm) below the water return. You may plug the return jet hole at this time. ****IMPORTANT**DO NOT PLUG THE SKIMMER DRAIN HOLE** (located at the base of the skimmer). Remove all hoses attached to the skimmer and return fittings. Do not let water freeze in the skimmer. Leave the skimmer attached to the pool wall and ensure that the skimmer lid is installed. **DO NOT DRAIN ALL THE WATER OUT OF THE POOL.**
- b. Depending on your area and if the freezing point is more aggressive, for example 50% is frozen into ice, we strongly suggest to lowering the water to lowest point. Depending on how great the deep freeze in your area **we suggest you consult with your local dealer about procedures on lowering the water level throughout the winter.** We also suggest throughout the autumn season to continually check this level before freezing season starts, as it must not reach the skimmer holes at any time during the winter. Remove any snow which may accumulate on the top ledge.

STEP 5) FILTER PREPARATION

- a. Disconnect the hoses from the filter. Remove and store the filter, ladder and all other removable parts from around the pool. The filter should be clear of any foreign objects and water should be removed from the filter and pump. See the manufacturer's instructions. Store the pump in a temperature controlled environment (so that it is not damaged by changes in temperature).

STEP 6) WINTER COVER

- a. For the winter cover we suggest to lower the water level to 1 inch (2.5cm) below the water return. In some areas your dealer may ask you to install it differently in order to protect the pool and the cover. Contact your local dealer to verify the correct procedure for your pool.
- b. If using a winter cover, make sure to place a ball underneath so that rainwater falls into the pool. An accumulation of too much water on the cover could place pressure on the pool, causing damage and invalidating the guarantee. Depending on how great the deep freeze in your area we suggest you consult with your local dealer about procedures on leaving the pool cover throughout the winter.

Section
5

POOL MAINTENANCE WINTERIZING YOUR POOL

CLOSING YOUR ABOVE GROUND POOL FOR THE WINTER CONTINUED



IMPORTANT

Never let more than 30 cm (1') of snow accumulate on the pool wall; the wall is designed to support the lateral pressure of the pool water, not vertical pressure. With spring thaw, if water leaks from the skimmer or return outlet opening, place a tube at the opening so that the water will run off as far away from the basin of the pool as possible. PLEASE NOTE: Do not strike or hit a frozen pool. This would damage it. Do not disturb the pool till spring. If you have left the winter cover on the pool, make sure to remove accumulated snow after heavy snow falls.



Important Note:

Whatever the type of valve or extension hose used, you must follow the technique described in this document to close your pool, otherwise your guarantee may be cancelled. Make sure to use antifreeze designed for pools.



Important Note:

An unsealed leak may comprise or cancel the guarantee on your pool.
Never leave water in any of the filtration system components due to the risk of damage during freezing.

Section 5

POOL MAINTENANCE SPRINGTIME CLEANING OF YOUR POOL

PREPARING YOUR POOL IN THE SPRING

At the end of winter, allow the ice in the pool to thaw completely. When the temperature reaches approximately 10 °C (50 °F), you have to restart your filtration system, since algae and bacterial form more quickly as it gets warmer. Here is how to prepare your pool in a few simple easy steps.

- a. If your pool is equipped with a pool cover, remove the cover and cushion. Carefully remove with a hose any rainwater that has accumulated on the cover so it does not fall into your pool. Clean your cover and cushion and let them dry. Store them in a dry clean place.
- b. Attach the return inlet and skimmer to the filter. Bring the water level up to the middle of the skimmer. Get your filter working. Clean the bottom of the pool with the vacuum, taking care to place the filter in the “waste/drain” position. In this way you will eliminate particles of dirt without disturbing the sand in the filter, and will considerably reduce the need for “backwash rinsing” of the filter.
- c. Now that you have purified the water, you have to test it. It is very important that the pH level of your pool be between 7.6 and 7.8 and the pool’s alkaline content be between 80 ppm and 130 ppm. If you are unable to attain these levels, please contact your retailer who will gladly do these tests for you.



 **Important Note:**
Do not drain your pool to clean the water unless absolutely necessary (the water is recyclable). If you do empty your pool, don't leave it empty for too long or expose it to direct sunlight, as the liner may shrink.

**Section
5**

**POOL MAINTENANCE
SPRINGTIME CLEANING OF YOUR POOL**

PREPARING YOUR POOL IN THE SPRING CONTINUED

- d. When the pH and alkaline levels are ideal, apply a shock-treatment or chlorinate your water. Let it filter for 24 hours and again verify both the pH and free chlorine levels.
NOTE: Add chemical products to your pool after sunset, as sunlight rapidly destroys chlorine.

- e. Let it filter for several days until the water is clear and the pH and free chlorine levels have stabilized. Add a conditioner/stabilizer by carefully following the manufacturer's instructions. This will stop the chlorine from evaporating quickly in sunlight. Add the quantity of algicide required to prevent algae.

- f. You may now begin regular maintenance of your pool. Don't forget to obtain a new set of solutions for your water analysis kit every spring. The old solutions may give false results.

- g. Make sure that the skimmer (screws and adapter) is properly in place and tighten the water return fittings to prevent leakage and premature rusting of the pool wall or the lower part of the bottom rail.

HAVE FUN!

IF YOU FOLLOW THESE TIPS AND ASK YOUR DEALER FOR ANY OTHER ADVICE YOU MAY NEED, YOU WILL HAVE ALL THE INFORMATION NECESSARY TO GET YOUR POOL OPERATING AGAIN.

